

Table of contents

Overview/Quick guide	1
General information	2
Locking and unlocking	3
Seat and seat belts	4
Instruments and controls	5
Starting and driving	6
For pleasant driving	7
For emergencies	8
Vehicle care	9
Maintenance	10
Specifications	11
Alphabetical index	12

Instruments and Controls

1 Instruments and Controls

E08500103538

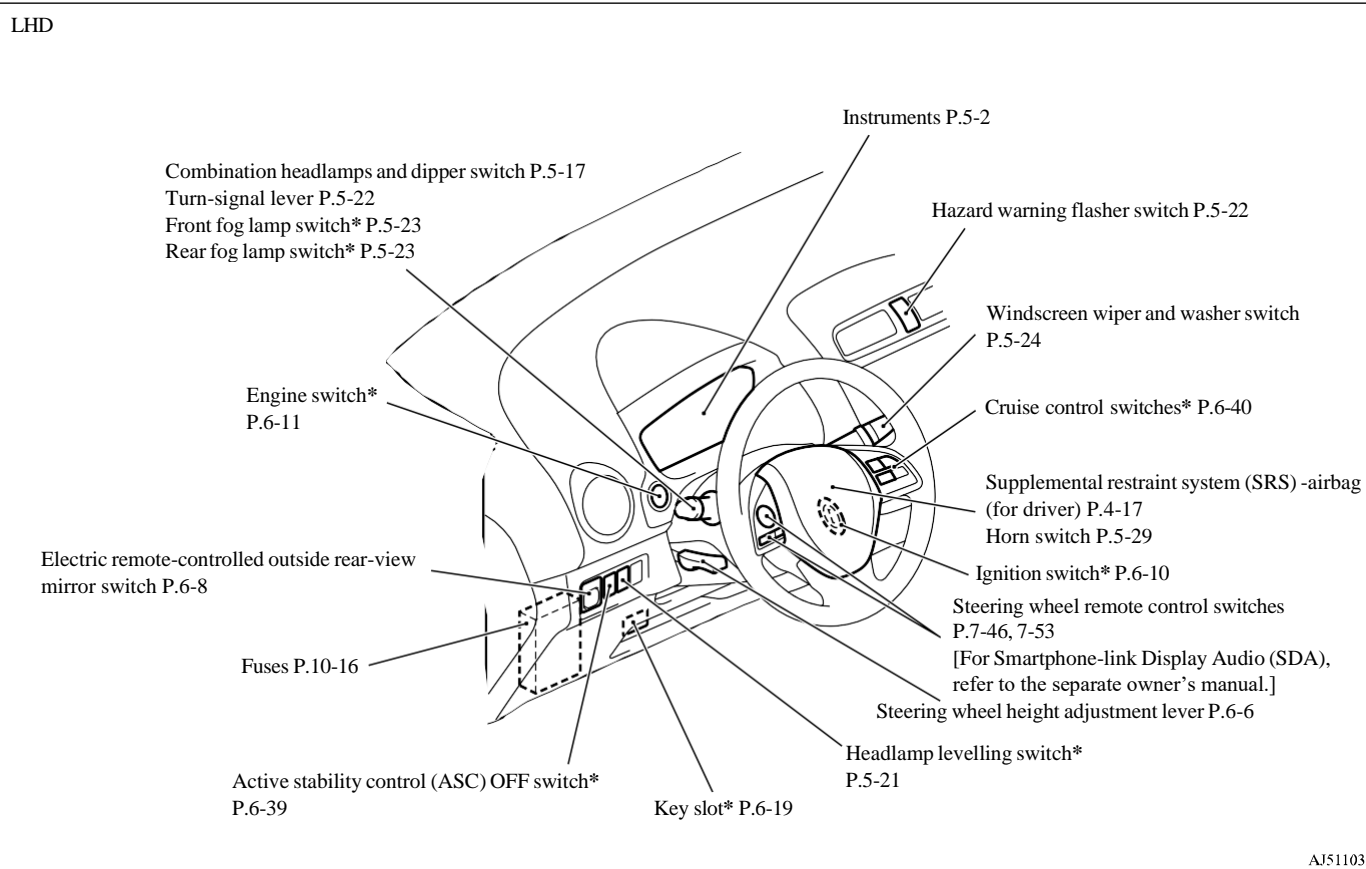

AJ5110323

1-1 Overview/Quick guide

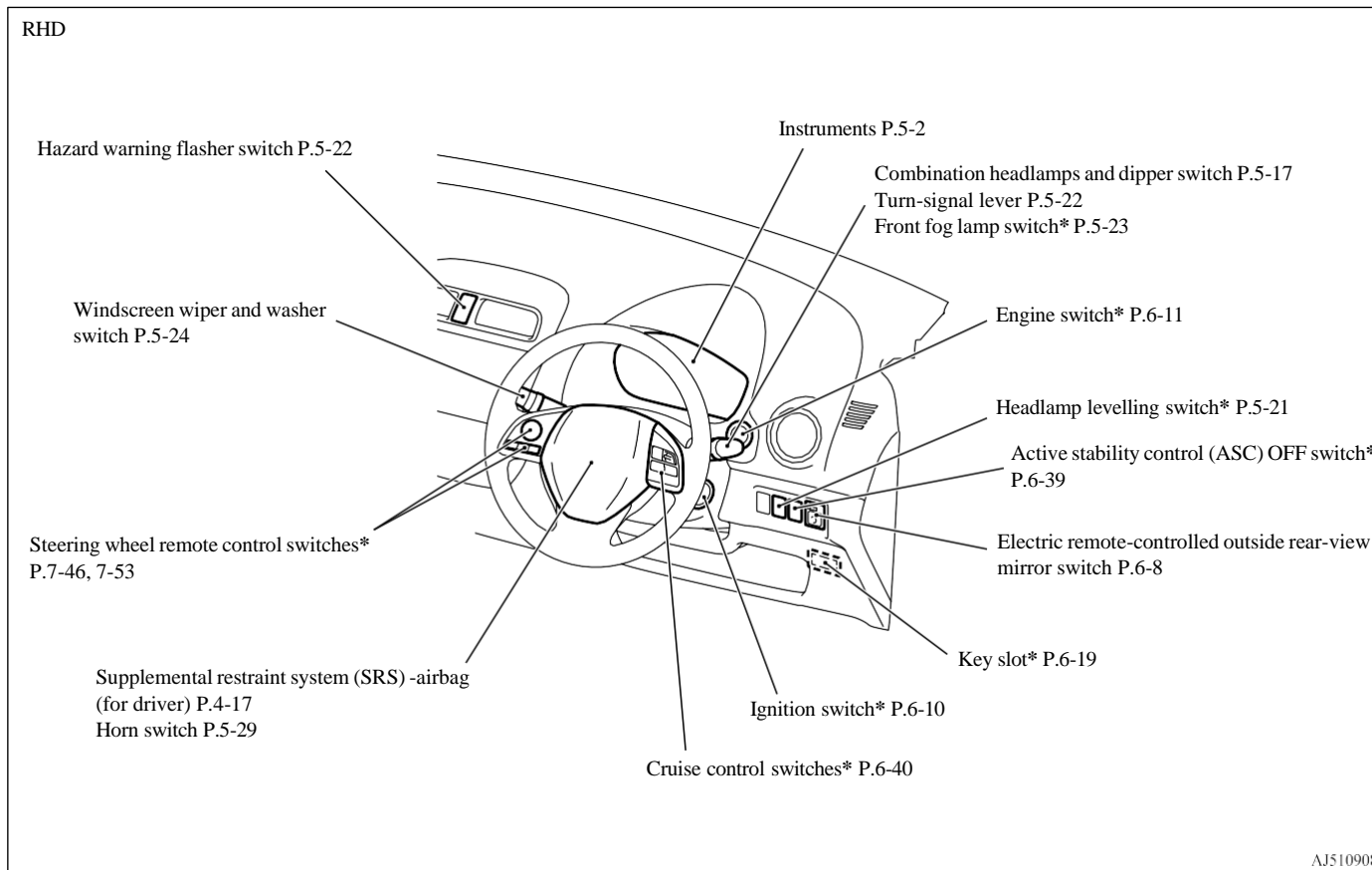

Instruments and Controls

1

LHD

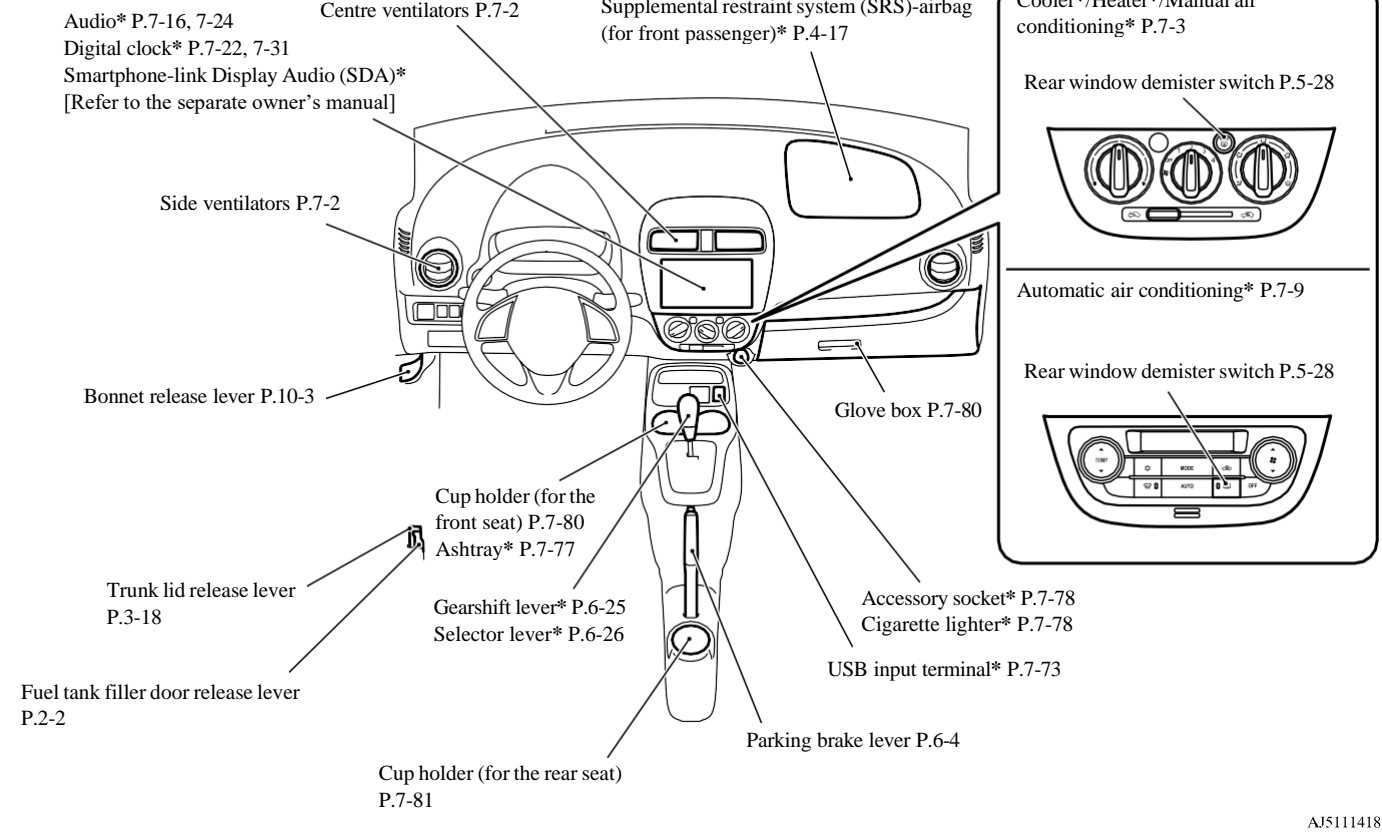

Instruments and Controls

1

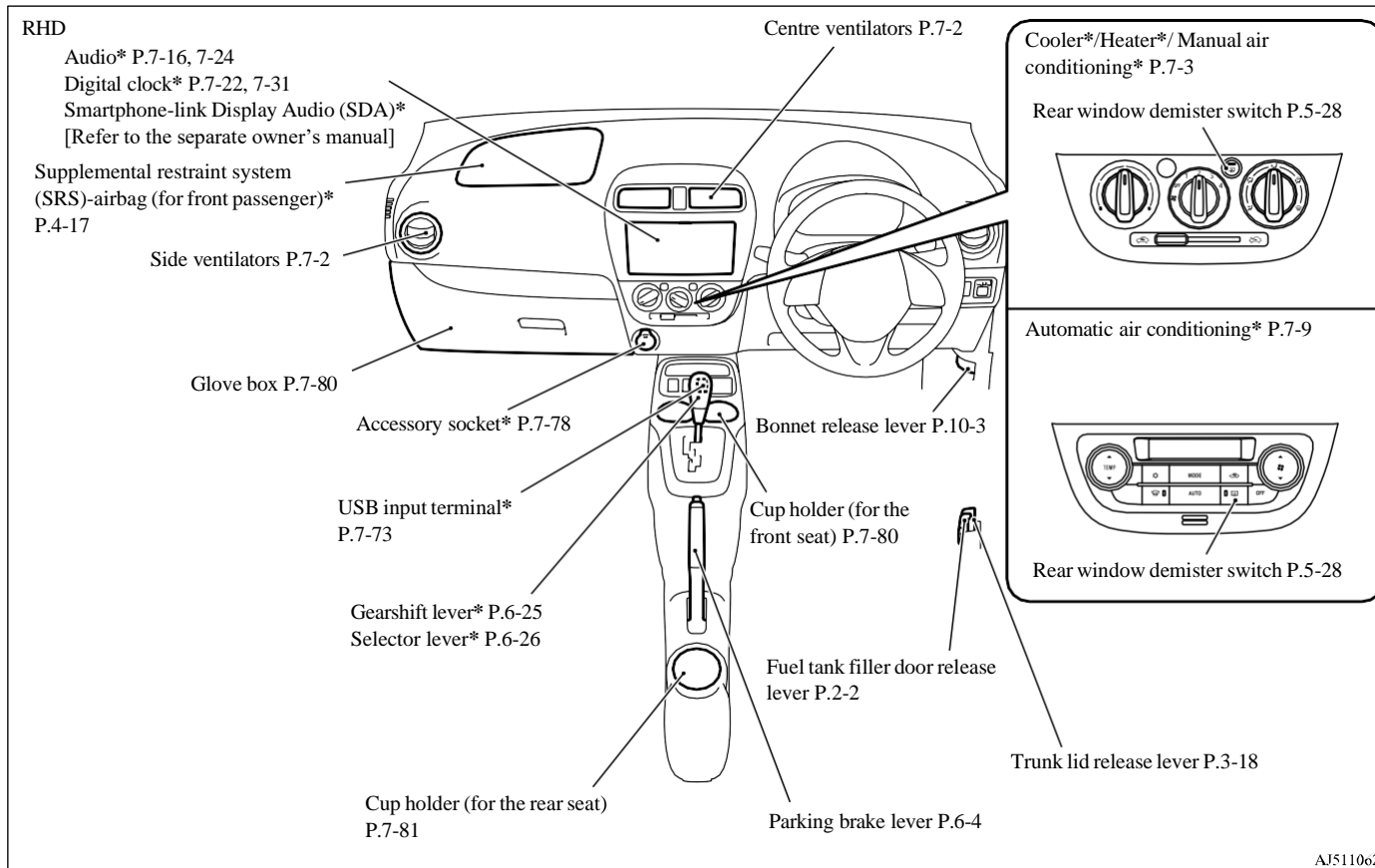

Interior

1 Interior

E08500202806

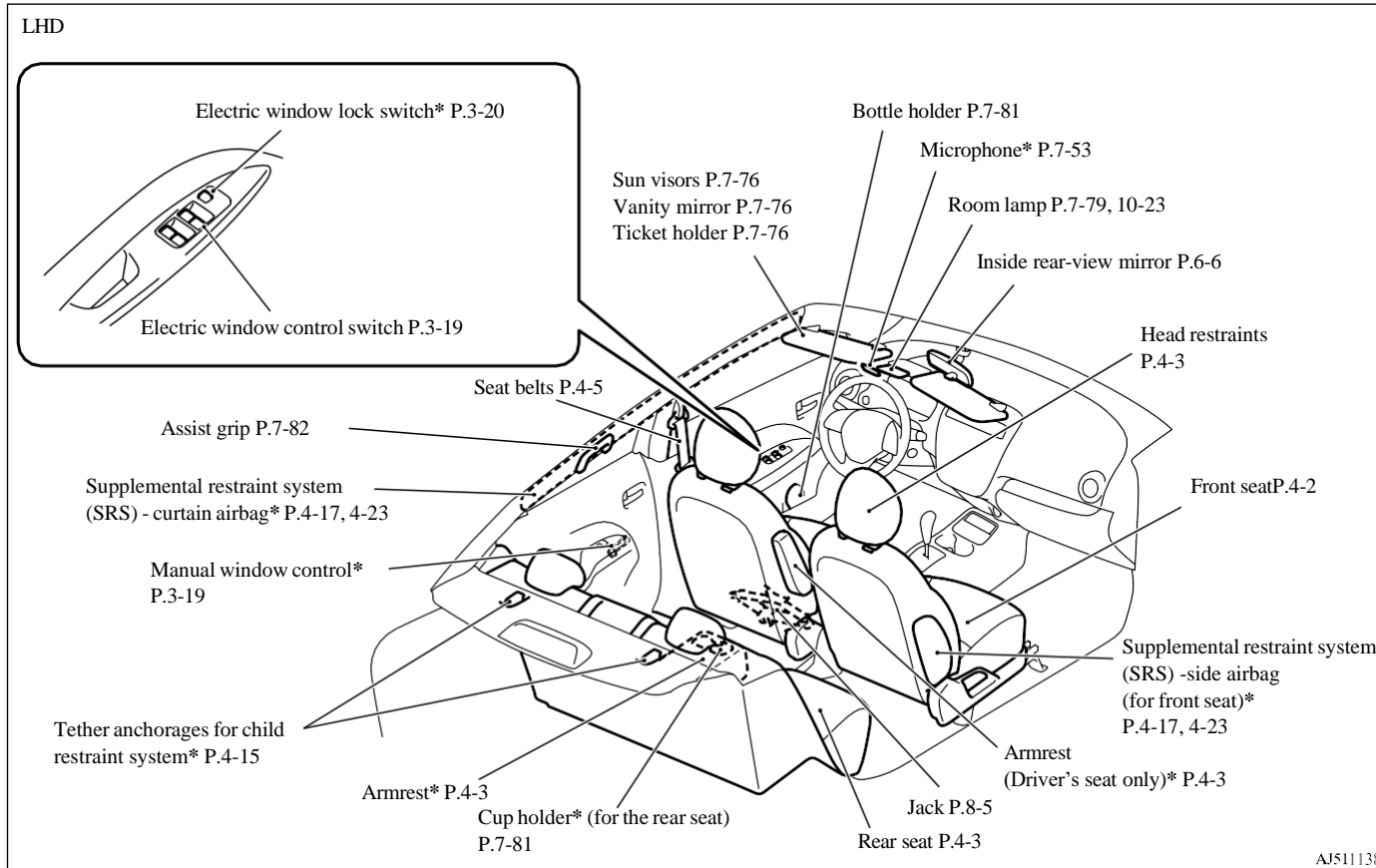

Interior

1

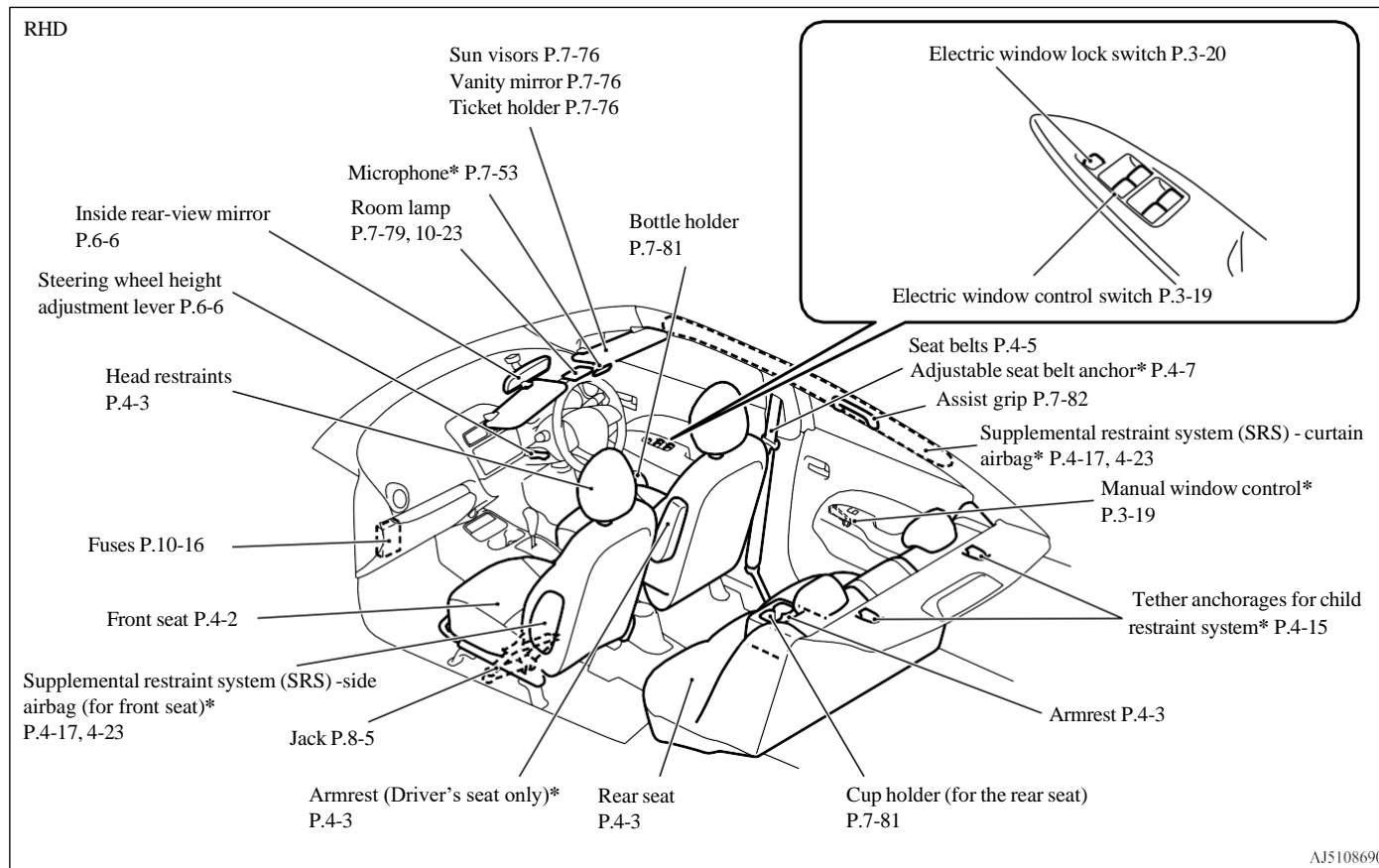

Trunk area

1 Trunk area

E0850180081

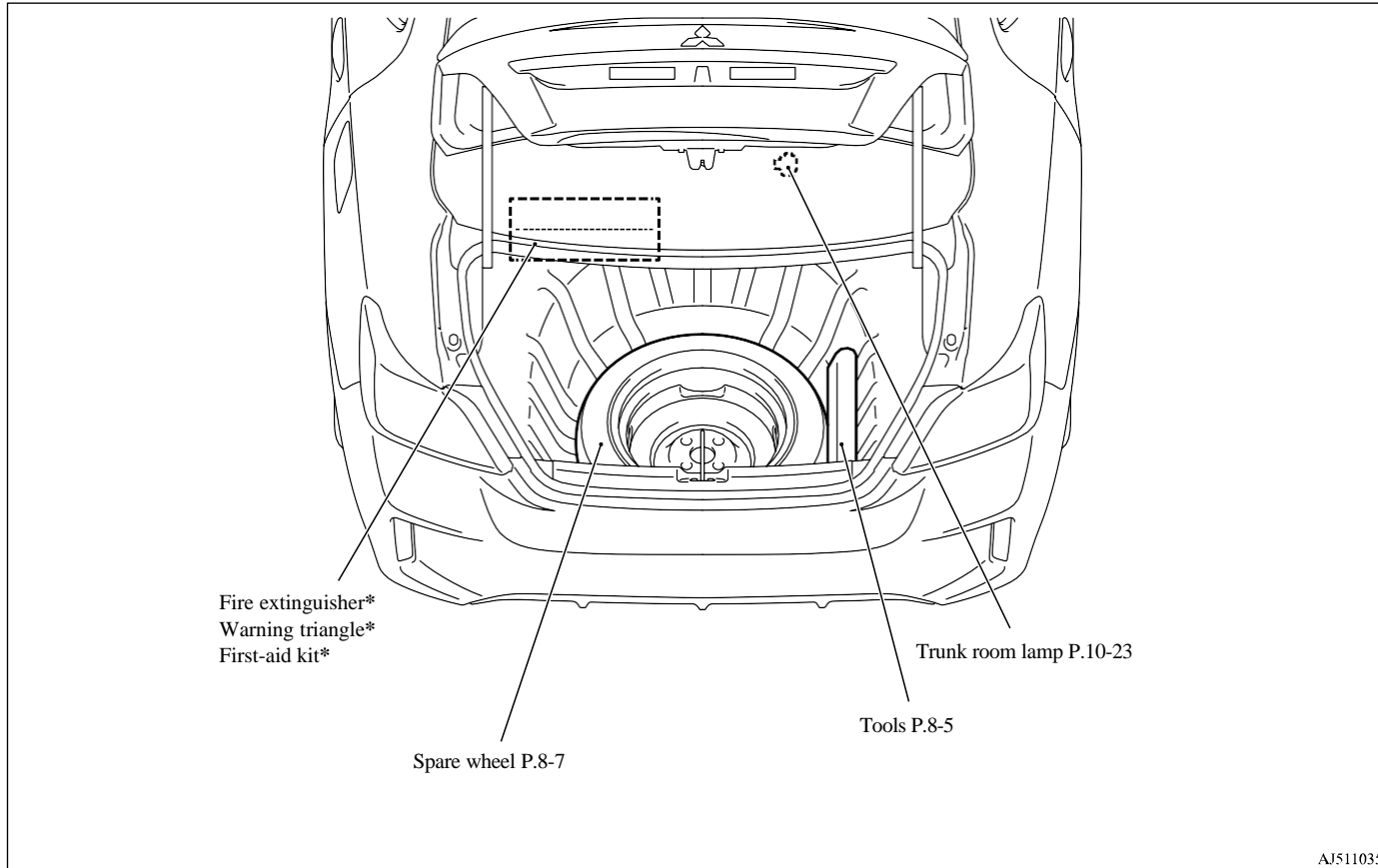

AJ5110352

1-7 Overview/Quick guide

Exterior

1

E08500404033

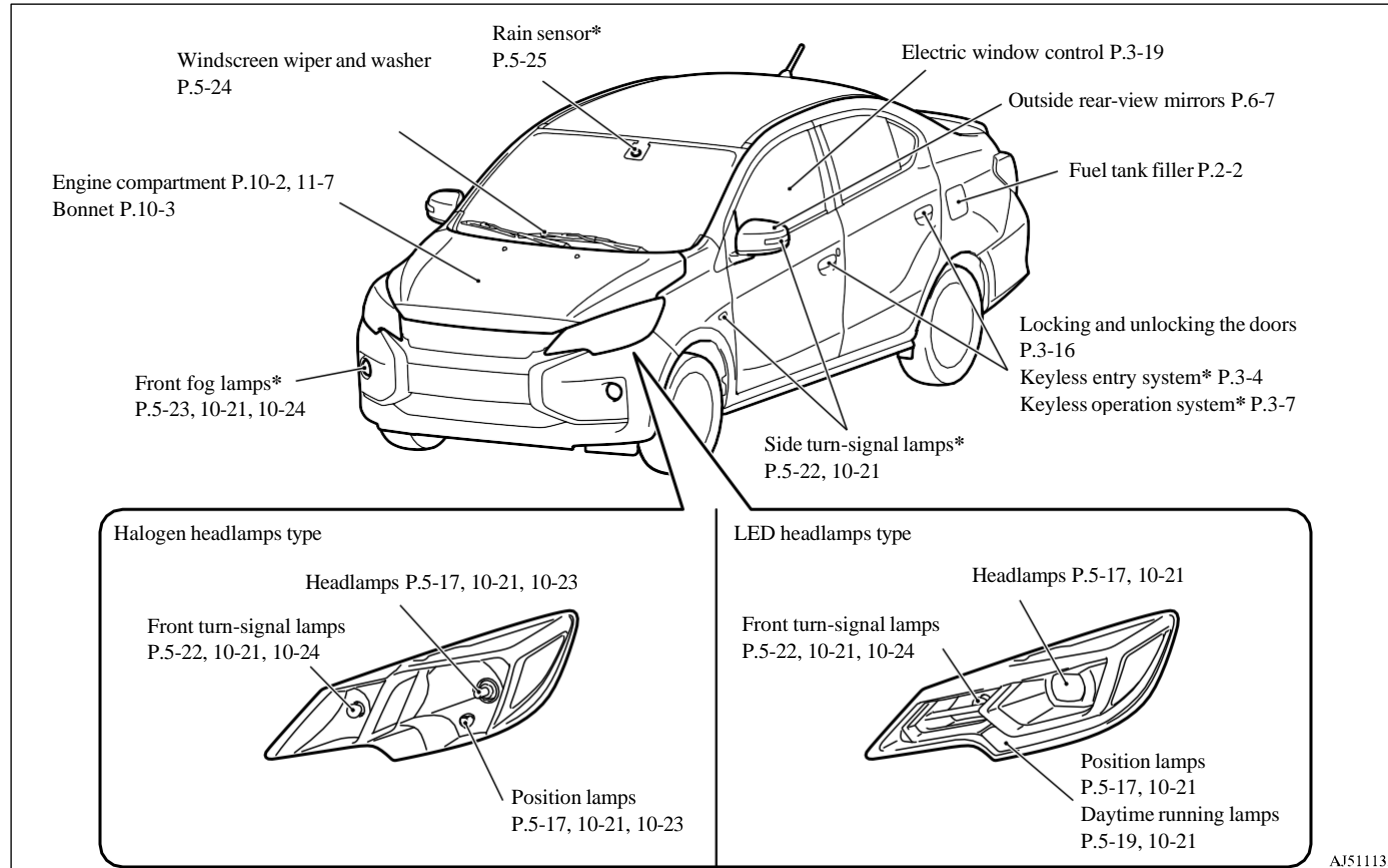

AJ5111359

Exterior

1

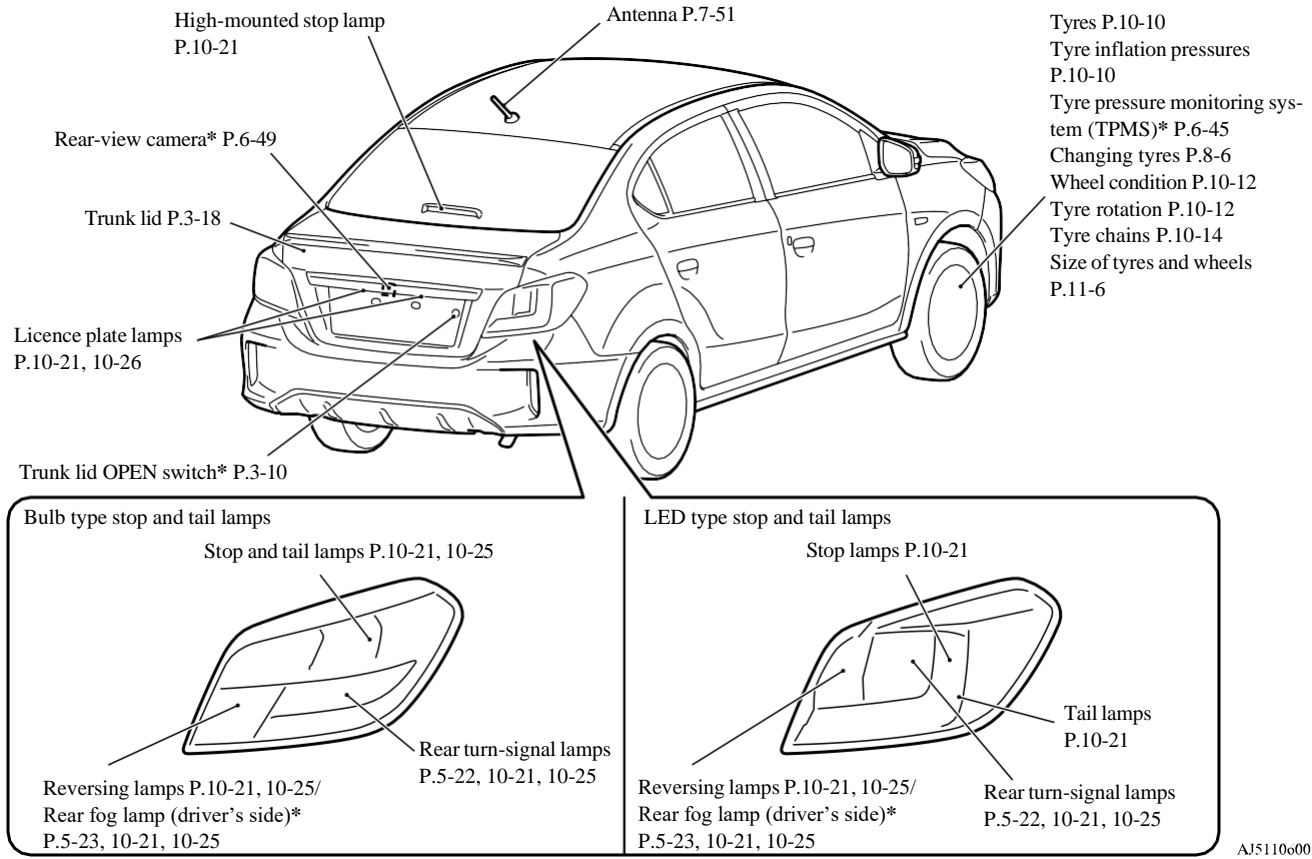

Quick guide

E08500500010

Lock and unlock the doors and trunk lid

E08500602187

Keyless entry system*

Press the remote control switch, and all the doors will be locked or unlocked or the trunk lid will be opened as desired.

The remote control switch will operate within approximately 4 m from the vehicle.

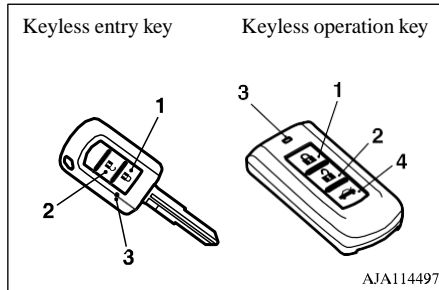

AJA114497

- 1- LOCK switch
- 2- UNLOCK switch
- 3- Indicator lamp
- 4- Electric trunk lid switch

Refer to “Keyless entry system” on page 3-4.

Keyless operation system*

When you are carrying the keyless operation key, if you press the driver’s door lock/unlock switch (A) within the operating range, all the doors are locked/unlocked.

If you press and hold down the trunk lid OPEN switch (B) within the operating range, the trunk lid is opened.

The operating range is approximately 70 cm from the driver’s door lock/unlock switch and the trunk lid OPEN switch.

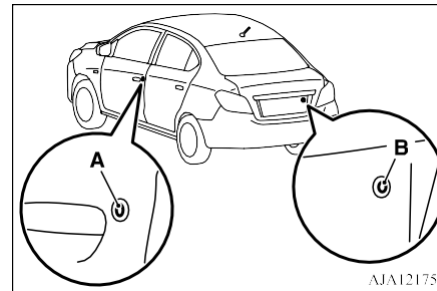

AJA121750

Refer to “Keyless operation system” on page 3-7.

Around the driver’s seat

E08500802509

1

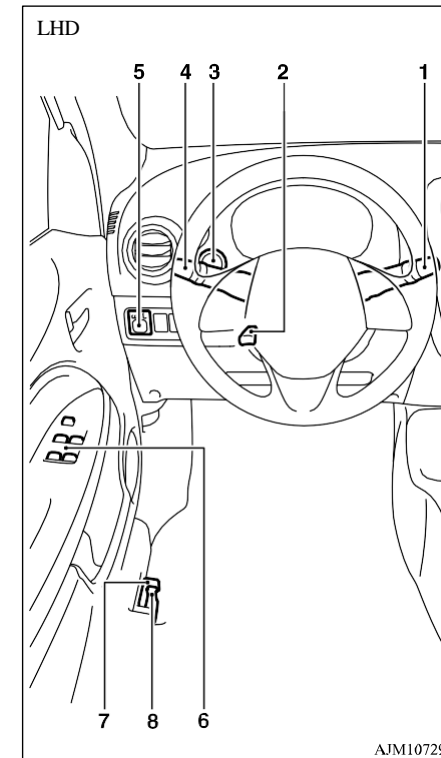

AJM107297

Quick guide

1

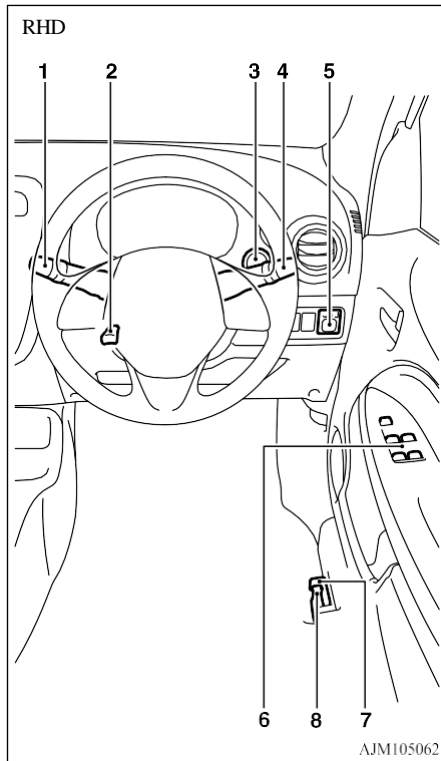

1-Wiper and washer switch

Except for vehicles equipped with rain sensor

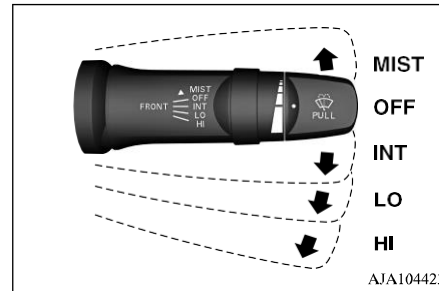

- MIST- Misting function
The wipers will operate once.
- OFF- Off
- INT- Intermittent (Speed sensitive)
- LO- Slow
- HI- Fast

Vehicles equipped with rain sensor

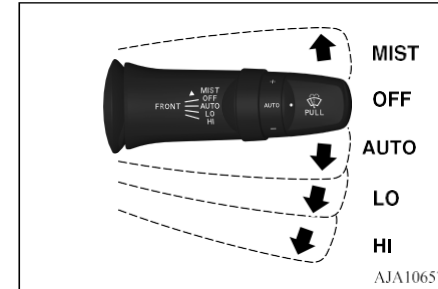

- MIST- Misting function
The wipers will operate once.
- OFF- Off
- AUTO- Auto-wiper control
Rain sensor
The wipers will automatically operate depending on the degree of wetness on the windscreen.
- LO- Slow
- HI- Fast

The washer fluid will be sprayed onto the windscreen by pulling the lever towards you.

Refer “Wiper and washer switch” on page 5-24.

2-Steering wheel height adjustment

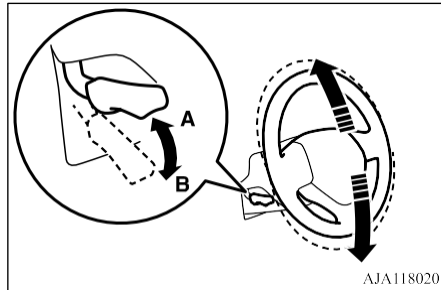

A- Locked
B- Release

1. Release the lever while holding the steering wheel up.
2. Adjust the steering wheel to the desired position.
3. Securely lock the steering wheel by pulling the lever fully upward.

Refer “Steering wheel height adjustment” on page 6-6.

3-Engine switch*

If you are carrying the keyless operation key, you can start the engine. If you press the engine switch without depressing the brake pedal (CVT) or the clutch pedal (M/T), you can change the operation mode in the order of OFF, ACC, ON, OFF.

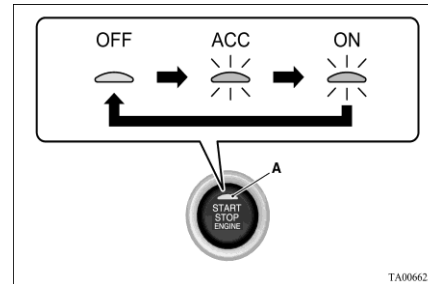

- OFF- The indicator lamp (A) on the engine switch turns off.
- ACC- The indicator lamp on the engine switch illuminates orange.
- ON- The indicator lamp on the engine switch illuminates green.

Refer “Engine switch” on page 6-11.

4-Combination headlamps

Rotate the switch to turn on the lamps.

Type 1

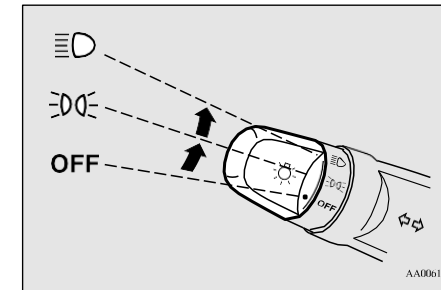

OFF	All lamps off {except for daytime running lamps (if so equipped)}
	Position, tail, licence plate and instrument panel lamps on
	Headlamps and other lamps go on

Quick guide

1 Type 2

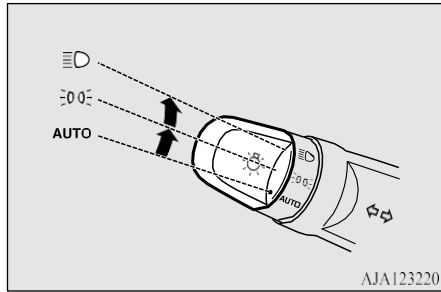

AUTO	With the ignition switch or the operation mode is in ON, headlamps, position, tail, licence plate, and instrument panel lamps turn on and off automatically in accordance with outside light level. {Daytime running lamps (if so equipped) will go on while the tail lamps are off.} All lamps turn off automatically when the ignition switch is turned to "OFF" position or the operation mode is put in OFF.
	Position, tail, licence plate and instrument panel lamps on
	Headlamps and other lamps go on

Refer "Combination headlamps and dipper switch" on page 5-17.

1-13 Overview/Quick guide

4-Turn-signal lever

The turn-signal lamps flash when the lever is operated

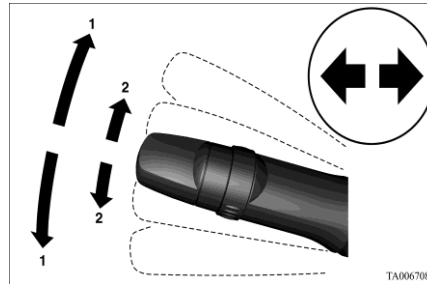

- 1- Turn-signals
- 2- Lane-change signals

Refer "Turn-signal lever" on page 5-22.

5-Electric remote-controlled outside rear-view mirrors

To adjust the mirror position

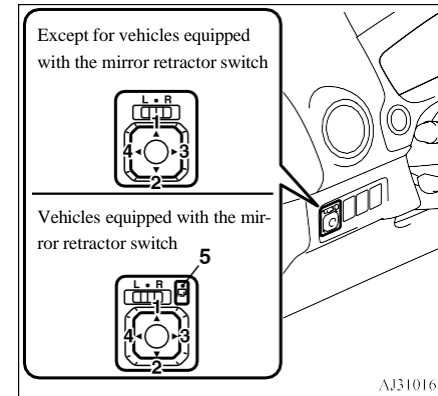

- L- Left outside mirror adjustment
- R- Right outside mirror adjustment
- 1- Up
- 2- Down
- 3- Right
- 4- Left
- 5- Mirror retractor switch

Refer "To adjust the mirror position" on page 6-8.

6- Electric window control

Press the switch down for opening the window, and pull the switch for closing.

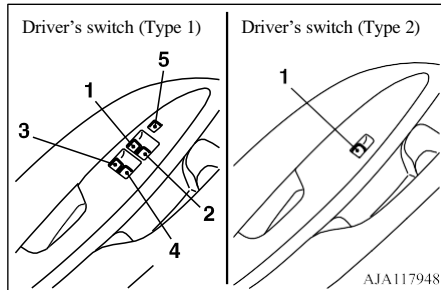

- 1- Driver's door window
- 2- Front passenger's door window
- 3- Rear left door window
- 4- Rear right door window
- 5- Lock switch

Lock switch (Type 1)

If you press the switch (5), the passenger's switches cannot be operated. To cancel, press it once again.

Refer "Electric window control" on page 3-19.

7- Trunk lid release lever

Pull the release lever located beside the driver's seat.

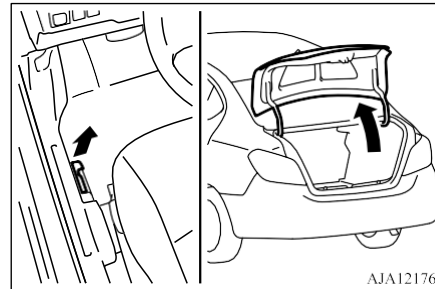

Refer "Trunk lid" on page 3-18.

8-Fuel tank filler door release lever

Open the fuel tank filler door.
The fuel tank filler is located on the rear left side of your vehicle.

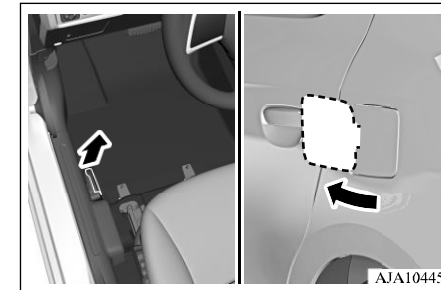

Refer "Filling the fuel tank" on page 2-2.

Quick guide

**1 Automatic transmission
INVECS-III CVT (Intelligent
& Innovative Vehicle Electronic
Control System III)***

E08501001598

Selector lever operation

The CVT selects an optimum gear ratio automatically, depending on the speed of the vehicle and the position of the accelerator pedal.

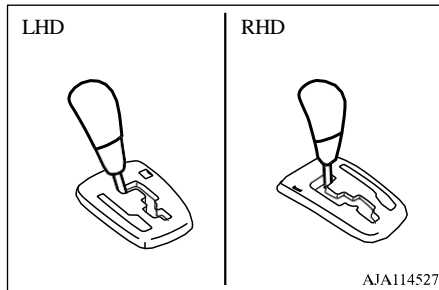

AJA114527

LHD (5 positions)

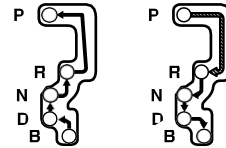

LHD (6 positions)

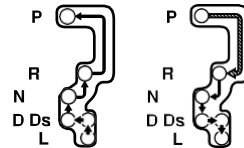

RHD

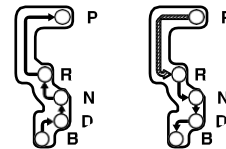

AJE101680

	While depressing the brake pedal, move the selector lever through the gate.
	Move the selector lever through the gate.

Selector lever positions

“P” PARK

This position locks the transmission to prevent the vehicle from moving. The engine can be started in this position.

“R” REVERSE

This position is to back up.

“N” NEUTRAL

At this position the transmission is disengaged.

“D” DRIVE

This position is for normal driving.

“Ds” DOWNSHIFT & SPORTY DRIVING (6 Position Type)

Use when engine braking is needed, or for high-power sport drive.

“B” BRAKE (5 Position Type)

This position is for use when light engine braking at high-speed is needed, or driving up

very steep hills and for engine braking at low speeds when descending steep gradients.

“L” LOW (6 Position Type)

This position is for driving up very steep hills and for engine braking at low speeds when driving down steep hills.

WARNING

- This position can be used for maximum engine braking.
- Be very careful not to shift into “L” (LOW) suddenly.
- Sudden engine braking may cause the tyres to skid.
- Select this position according to the road conditions and vehicle speed.

Refer to “Automatic transmission INVECS-III CVT (Intelligent & Innovative Vehicle Electronic Control System III)” on page 6-26.

Instruments

E08501101254

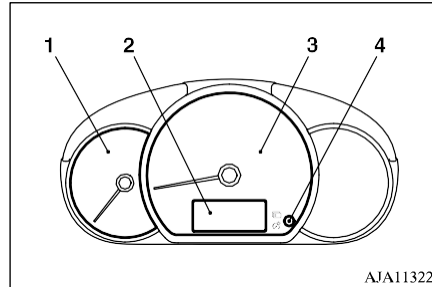

AJA113227

- 1- Tachometer
- 2- Multi-information display
- 3- Speedometer
- 4- Multi-information display switch

Refer to “Instruments” on page 5-2.

Multi-information display

Each time you lightly press the multi-information display switch, the information display switches odometer, tripmeter, meter illumination control, driving range and average fuel consumption, etc..

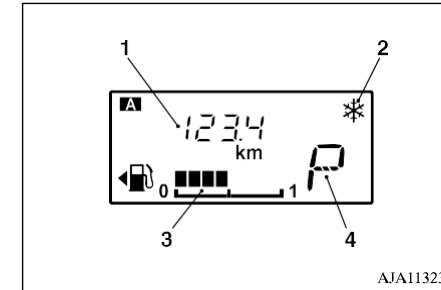

AJA113230

- 1- Information display
- 2- Frozen road warning* P.5-7
- 3- Fuel remaining display
- 4- Selector lever position display*

Refer to “Multi-information display” on page 5-2.

1

Quick guide

1 Indicator and warning lamps

E08501301328

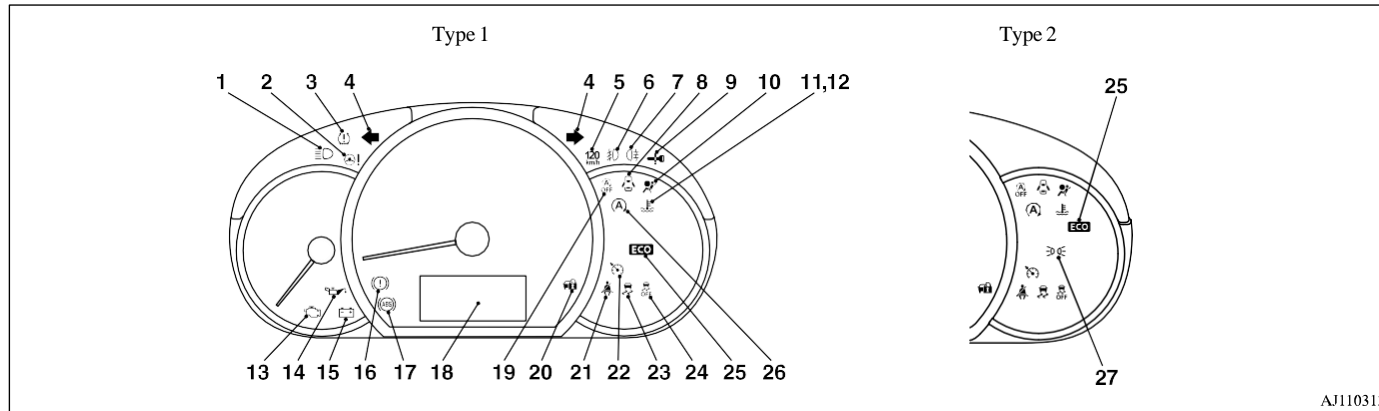

AJ1103134

- 1- High-beam indicator lamp → P.5-13
- 2- Electric power steering system (EPS) warning lamp → P.6-37
- 3- Tyre pressure monitoring system warning lamp* → P.6-45
- 4- Turn-signal indicator lamps/Hazard warning indicator lamps → P.5-13
- 5- Speed warning lamp* → P.5-17
- 6- Front fog lamp indicator lamp* → P.5-13
- 7- Rear fog lamp indicator lamp* → P.5-13
- 8- Door-ajar warning lamp → P.5-17

- 9- For details, refer to “Warning activator” on page 3-12. (if so equipped)
- 10- Supplemental restraint system (SRS) warning lamp → P.4-26
- 11- High coolant temperature warning lamp (red) → P.5-16
- 12- Low coolant temperature indicator lamp (green) → P.5-13
- 13- Check engine warning lamp → P.5-15
- 14- Oil pressure warning lamp → P.5-16
- 15- Charge warning lamp → P.5-16
- 16- Brake warning lamp → P.5-14

- 17- Anti-lock brake system (ABS) warning lamp* → P.6-36
- 18- Multi-information display → P.5-2
- 19- Auto Stop & Go (AS&G) OFF indicator lamp* → P.6-25
- 20- For details, refer to “Warning activator” on page 3-12. (if so equipped)
- 21- Seat belt warning lamp* → P.4-7
- 22- Cruise control indicator lamp* → P.6-41
- 23- Active Stability Control (ASC) indicator lamp* → P.6-39

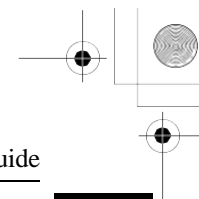
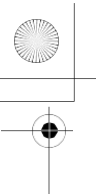

- 24- Active Stability Control (ASC) OFF indicator lamp* → P.6-39
- 25- ECO indicator lamp* → P.5-14
- 26- Auto Stop & Go (AS&G) indicator lamp* → P.6-20
- 27- Position lamp indicator lamp* → P.5-13

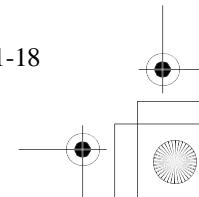
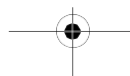
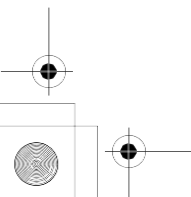
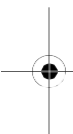

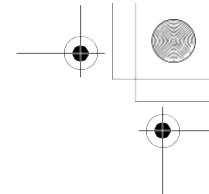
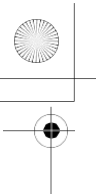

Handwriting practice area consisting of ten horizontal dashed lines.

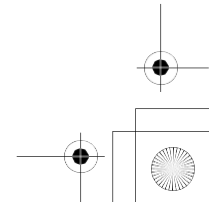
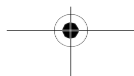

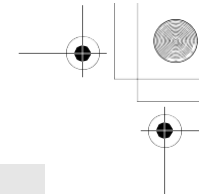
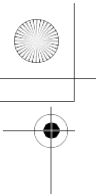

General information

2

Fuel selection	2-2
Filling the fuel tank	2-2
Installation of accessories	2-4
Modification/alterations to the electrical or fuel systems	2-5
Genuine parts	2-5
Used engine oils safety instructions	2-5
Event Data Recording	2-5

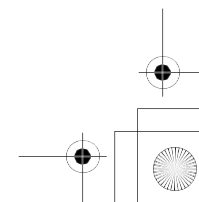
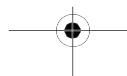
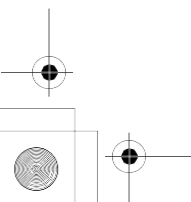

Fuel selection

2

Fuel selection

E00200105953

Recommended fuel	Vehicles except for Singapore and Azerbaijan Unleaded petrol octane number 90 RON or higher
	Vehicles for Singapore and Azerbaijan Unleaded petrol octane number 95 RON or higher

CAUTION

- The use of leaded fuel can result in serious damage to the engine and catalytic converter. Do not use the leaded fuel.

NOTE

- Vehicles for Singapore and Azerbaijan have the knock control system so that you can use unleaded petrol 90 RON or higher as an emergent measure in case unleaded petrol 95 RON or higher is not available on journey, etc. In such a case, you don't need to adjust the engine specially.
In case of using unleaded petrol 90 RON or higher, the engine performance level is reduced.

NOTE

- Repeatedly driving short distance at low speeds can cause deposits to form in the fuel system and engine, resulting in poor starting and poor acceleration. If these problems occur, you are advised to add a detergent additive to the gasoline when you refuel the vehicle. The additive will remove the deposits, thereby returning the engine to a normal condition. Be sure to use a MITSUBISHI MOTORS GENUINE FUEL SYSTEM CLEANER. Using an unsuitable additive could make the engine malfunction. For details, please contact the nearest authorised MITSUBISHI MOTORS dealer.
- Poor quality petrol can cause problems such as hard starting, stalling, engine noise and hesitation. If you experience these problems, try another brand and/or grade of petrol. If the check engine warning lamp flashes, have the system checked immediately at an authorised MITSUBISHI MOTORS dealer.

Ethanol (Gasohol)

A mixture of up to 10 % ethanol (grain alcohol) and 90 % unleaded petrol may be used in your vehicle, provided the octane number is at least as high as that recommended for unleaded petrol.

CAUTION

- Do not use more than 10 % concentration of ethanol (grain alcohol) by volume. Use of more than 10 % concentration may lead to damage to your vehicle fuel system, engine, engine sensors and exhaust system.
- Do not operate your vehicle on gasoline containing methanol. Using this type of alcohol could adversely affect the vehicle's performance and damage critical parts of the vehicle's fuel system.

Filling the fuel tank

E00200204306

WARNING

- When handling fuel, comply with the safety regulations displayed by garages and filling stations.
- Gasoline is highly flammable and explosive. You could be burned or seriously injured when handling it. When refueling your vehicle, always turn the engine off and keep away from flames, sparks, and smoking materials. Always handle fuel in well-ventilated outdoor areas.
- Before removing the fuel tank filler cap, be sure to get rid of your body's static electricity by touching a metal part of the car or fuel pump. Any static electricity on your body could create a spark that ignites fuel vapor.

Filling the fuel tank

⚠ WARNING

- Perform the whole refueling process (opening the fuel tank filler door, removing the fuel tank filler cap, etc.) by yourself. Do not let any other person come near the fuel tank filler. If you allowed a person to help you and that person was carrying static electricity, fuel vapor could be ignited.
- Do not move away from the fuel tank filler until refueling is finished. If you moved away and did something else (for example, sitting on a seat) part-way through the refueling process, you could pick up a fresh charge of static electricity.
- If the fuel tank filler cap must be replaced, use only a MITSUBISHI MOTORS genuine part.

Fuel tank capacity

42 litres

Refueling

1. Before filling with fuel, stop the engine.
2. The fuel tank filler is located on the rear left side of your vehicle.
Open the fuel tank filler door with the release lever located on the side of the driver's seat.

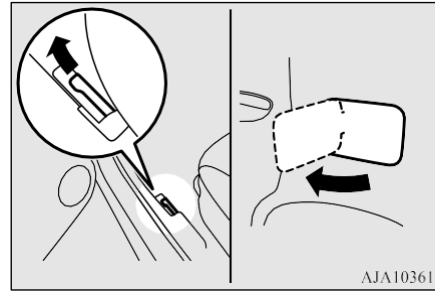

3. Open the fuel tank filler tube by slowly turning the cap anticlockwise.

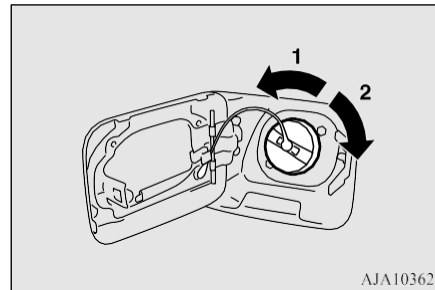

- 1- Remove
- 2- Close

⚠ CAUTION

- Since the fuel system may be under pressure, remove the fuel tank filler cap slowly. This relieves any pressure or vacuum that might have built up in the fuel tank. If you hear a hissing sound, wait until it stops before removing the cap. Otherwise, fuel may spray out, injuring you or others.

4. While filling with fuel, hang the fuel tank filler cap cord on the hook located on the inside of the fuel tank filler door.

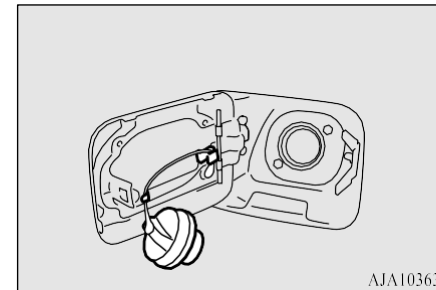

5. Insert the gun in the tank port as far as it goes.

⚠ CAUTION

- Do not tilt the gun.

6. When the gun stops automatically, do not fill with fuel any more.

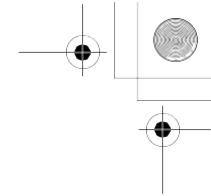
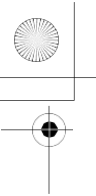

2

Installation of accessories

7. To close, turn the fuel tank filler cap slowly clockwise until you hear clicking sounds, then gently push the fuel tank filler door closed.

Installation of accessories

E00200303124

Before fitting any accessories, please consult your authorised MITSUBISHI MOTORS dealer.

CAUTION

- Your vehicle is equipped with a diagnosis connector for checking and servicing the electronic control system. Do not connect a device other than a diagnosis tool for inspections and service to this connector. Otherwise, the battery could be discharged, the electronic devices of the vehicle could malfunction, or other unexpected problems could result. In addition, malfunctions caused by connecting a device other than a diagnosis tool may not be covered under warranty.

- The installation of accessories, optional parts, etc., should only be carried out within the limits prescribed by law in your country, and in accordance with the guidelines and warnings contained within the documents accompanying this vehicle.

Only MITSUBISHI MOTORS approved accessories should be fitted to your vehicle.

- Improper installation of electrical parts could cause fire, please refer to the Modification/alteration to the electrical or fuel systems section within this owner's manual.
- Using a cellular phone or radio set inside the vehicle without an external antenna may cause electrical system interference, which could lead to unsafe vehicle operation.
- Tyres and wheels which do not meet specifications must not be used. Refer to the "Specifications" section for information regarding wheel and tyre sizes.
- Do not fail to read the accessories manuals prior to the installation of accessories, parts or other modifications to the vehicle!

Important points!

Due to the large number of accessory and replacement parts of different manufactures in the market, it is not possible, not only for MITSUBISHI MOTORS CORPORATION, but also an authorised MITSUBISHI MOTORS dealer, to check whether the

attachment or installation of such parts affects the driving safety of your vehicle.

Even when such parts are officially authorised, for example by a "general operators permit" (an appraisal for the part) or through the execution of the part in an officially approved manner of construction, or when a single operation permit following the attachment or installation of such parts, it cannot be deduced from that alone, that the driving safety of your vehicles has not been affected.

Consider also that there basically exists no liability on the part of the appraiser or the official. Only in the case of parts (MITSUBISHI MOTORS original replacement or exchange parts as well as MITSUBISHI MOTORS accessories) that are recommended and released by an authorised MITSUBISHI MOTORS dealer and that are attached or installed by an authorised MITSUBISHI MOTORS dealer can you assume, that optimal safety has been provided. The same also pertains to modifications of vehicles with respect to the production specifications. For your own safety, in such cases as well, you should only undertake modifications according to the recommendations of an authorised MITSUBISHI MOTORS dealer.

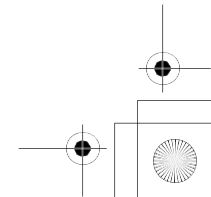
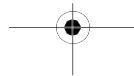
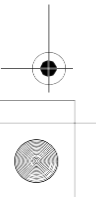

Modification/alterations to the electrical or fuel systems

E00200400430

MITSUBISHI MOTORS has always manufactured safe, high quality vehicles. In order to maintain this safety and quality, it is important that any accessory that is to be fitted, or any modifications carried out which involve the electrical or fuel systems, should be carried out in accordance with MITSUBISHI MOTORS guidelines.

CAUTION

- Please consult an authorised MITSUBISHI MOTORS dealer concerning any such fitment or modification. If the wires interfere with the vehicle body or improper installation methods are used (protective fuses not included, etc.), electronic devices may be adversely affected, resulting in a fire or other accident.

Genuine parts

E00200502086

Don't play around with substitutes. MITSUBISHI MOTORS has gone to great lengths to bring you a superbly crafted vehicle offering the highest quality and dependability. Don't reduce that quality and dependability by using substitute parts.

Modification/alterations to the electrical or fuel systems

Always use MITSUBISHI MOTORS Genuine Parts designed and manufactured to maintain your vehicle at top performance. The operation of vehicle components can be less efficient in case of using Non-Genuine Parts. Failure to use Genuine Parts may invalidate any future warranty claim. MITSUBISHI MOTORS will not be liable for any malfunction of your vehicle that may have been caused by the use of substitute parts in place of MITSUBISHI MOTORS Genuine Parts. At the MITSUBISHI MOTORS dealer you can also get appropriate advice and the assembling of Genuine Parts will be handled professionally.

MITSUBISHI MOTORS Genuine Parts are indicated as GENUINE PARTS, and are available at all authorised MITSUBISHI MOTORS dealers.

Used engine oils safety instructions

E00200600171

WARNING

- **Prolonged and repeated contact may cause serious skin disorders, including dermatitis and cancer.**
- **Avoid contact with the skin as far as possible and wash thoroughly after any contact.**
- **Keep out of reach of children.**

Event Data Recording

E00205900094

2

This vehicle is equipped with an event data recorder (EDR).

The main purpose of an EDR is to record, in certain crash or near crash-like situations, such as an airbag deployment or hitting a road obstacle, data that will assist in understanding how a vehicle's systems performed. The EDR is designed to record data related to vehicle dynamics and safety systems for a short period of time, typically 30 seconds or less.

The EDR in this vehicle is designed to record such data as:

- How various systems in your vehicle were operating;
- How far (if at all) the driver was depressing the accelerator and/or brake pedal; and,
- How fast the vehicle was traveling.

These data can help provide a better understanding of the circumstances in which crashes and injuries occur.

Event Data Recording

2

NOTE

- EDR data are recorded by your vehicle only if a non-trivial crash situation occurs; no data are recorded by the EDR under normal driving conditions and no personal data (e.g., name, gender, age, and crash location) are recorded. However, other parties, such as law enforcement, could combine the EDR data with the type of personally identifying data routinely acquired during a crash investigation.

To read data recorded by an EDR, special equipment is required, and access to the vehicle or the EDR is needed. In addition to the vehicle manufacturer, other parties, such as law enforcement, that have the special equipment, can read the information if they have access to the vehicle or the EDR.

2-6 General information

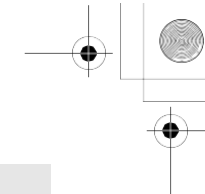
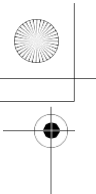

Locking and unlocking

Keys.....	3-2
Electronic immobilizer (Anti-theft starting system)*	3-3
Keyless entry system*.....	3-4
Keyless operation system*.....	3-7
Doors	3-16
Central door locks*	3-17
“Child-protection” rear doors.....	3-18
Trunk lid	3-18
Manual window control*	3-19
Electric window control	3-19

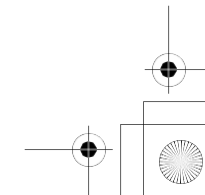
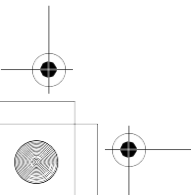

Keys

3

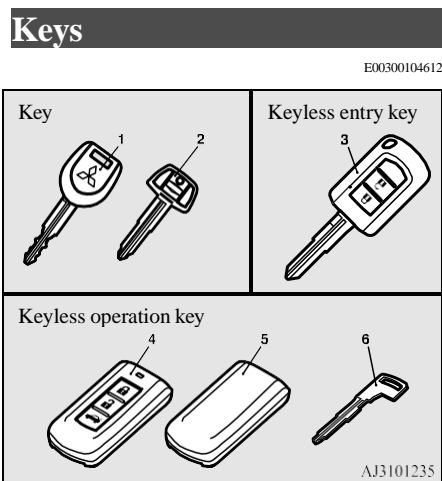

- 1- Master key
- 2- Master key (Plate)
- 3- Keyless entry key
- 4- Keyless operation key
- 5- Spare key
- 6- Emergency key

WARNING

- When carrying a remote control key on flights, do not press any switches on the key while on the plane. If a switch is pressed on the plane, the key emits electromagnetic waves, which could adversely affect the plane's flight operation. When carrying a remote control key in a bag, be careful that no switches on the key can be easily pressed by mistake.

NOTE

- On vehicles with electric immobilizer, the key (except for the emergency key) is a precision electronic part with a built-in signal transmitter. Please observe the following in order to prevent a malfunction.
 - Do not leave anywhere that is exposed to direct sunlight, for example on the dashboard.
 - Do not disassemble or modify.
 - Do not excessively bend the key or subject it to a strong impact.
 - Do not expose to water.
 - Keep away from magnetic key rings.
 - Keep away from audio systems, personal computers, TVs, and any other equipment that generates a magnetic field.

NOTE

- Keep away from devices that emit strong electromagnetic waves, such as cellular phones, wireless devices and high frequency equipment (including medical devices).
- Do not wash with ultrasonic cleaners or similar equipment.
- Do not leave the key where it may be exposed to high temperature or high humidity.
- On vehicles with electric immobilizer, the engine is designed so that it will not start if the ID code registered in the immobilizer computer and the key's ID code do not match. Refer to the section entitled "Electronic immobilizer" for details and key usage.

Key number tag

The key number is stamped on the tag as indicated in the illustration.

Make a record of the key number and store the key and key number tag in separate places, so that you can order a key from your authorised MITSUBISHI MOTORS dealer in the event the original keys are lost.

Electronic immobilizer (Anti-theft starting system)*

[Vehicles equipped with the master key]

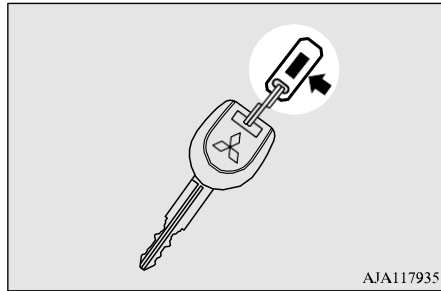

[Vehicles equipped with the keyless operation key]

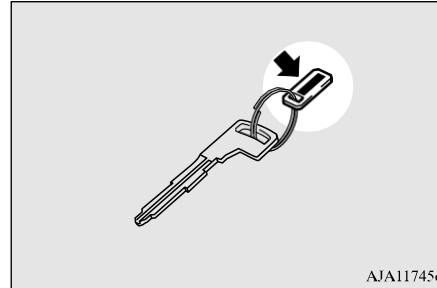

[Vehicles equipped with the keyless entry key]

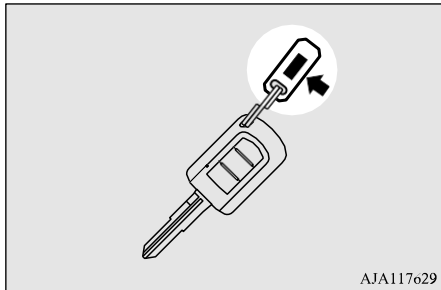

Electronic immobilizer (Anti-theft starting system)*

E00300203632

The electronic immobilizer is designed to reduce significantly the possibility of vehicle theft. The purpose of the system is to immobilize the vehicle if an invalid start is attempted. A valid start attempt can only be achieved, using a key “registered” to the immobilizer system.

CAUTION

- Don't make any alterations or additions to the immobilizer system; alterations or additions could cause failure of the immobilizer.

NOTE

- [Vehicles without keyless operation system] In the following cases, the vehicle may not be able to receive the registered ID code from the registered key and engine may not start.
 - When the key contacts a key ring or other metallic or magnetic object



- When the key grip contacts metal of another key

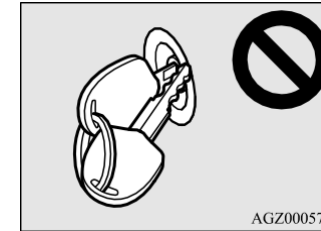

3

Keyless entry system*

3

NOTE

- When the key contacts or is close to other immobilizing keys (including keys of other vehicles)



In cases like these, remove the object or additional key from the vehicle key. Then try again to start the engine. If the engine does not start, contact an authorised MITSUBISHI MOTORS dealer.

- If you lose one of the master keys, the keyless entry keys or the keyless operation keys, contact an authorised MITSUBISHI MOTORS dealer as soon as possible. Refer to “Keys” on page 3-2.

To obtain a key, take your vehicle and all remaining keys to an authorised MITSUBISHI MOTORS dealer.

If you need an extra spare key, take your vehicle and all the keys to an authorised MITSUBISHI MOTORS dealer. All the keys have to be re-registered in the immobilizer computer unit.

For further information, please contact an authorised MITSUBISHI MOTORS dealer.

Keyless entry system*

E00300305259

Press the remote control switch, to lock and unlock all the doors or to open the trunk lid.

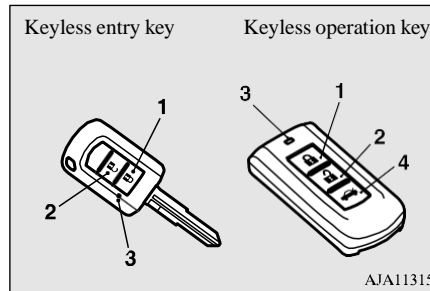

- 1- LOCK switch
- 2- UNLOCK switch
- 3- Indicator lamp
- 4- Electric trunk lid switch

To lock

Press the LOCK switch (1). All the doors will be locked. The turn-signal lamps will blink once. When they are locked with the room lamp switch in the middle (●) position, the room lamp also blink once.

To unlock

Press the UNLOCK switch (2). All the doors will be unlocked. If the room lamp switch is in the middle (●) position at this time, the room lamp will come on for approximately 15 seconds and the turn-signal lamps will blink twice.

To open the trunk lid (vehicles with keyless operation system)

Press the electric trunk lid switch (4) twice within about 5 seconds and the trunk lid will be opened. The trunk lid must be closed manually after it has been opened.

NOTE

- For vehicles equipped with the mirror retractor switch, the outside rear-view mirrors automatically retract or extend when all the doors are locked or unlocked using the remote control switches of the keyless entry system. Refer to “Starting and driving: Outside rear-view mirrors” on page 6-7.
- If the UNLOCK switch (2) is pressed and no door is opened within approximately 30 seconds, relocking will automatically occur.
- It is possible to modify functions as follows: For further information, please contact your authorised MITSUBISHI MOTORS dealer.

NOTE

- The time from pressing of the UNLOCK switch (2) to the moment of automatic locking can be changed.
- Activating the operation confirmation function (blinking of the turn-signal lamps) only during locking, or only during unlocking.
- The confirmation function (this indicates locking or unlocking of the doors with the blink of the turn-signal lamps) can be deactivated.
- The number of times the turn-signal lamps are blinked by the confirmation function can be changed.
- On vehicles with keyless operation system, the buzzer sound can be activated when a keyless operation is done.
- The keyless entry system does not operate in the following conditions:
 - The key is left in the ignition switch. (except for vehicles with keyless operation system)
 - The operation mode is not in OFF. (vehicles with keyless operation system)
 - A door is open or ajar.
- The remote control switch will operate within approximately 4 m from the vehicle. However, the operating range of the remote control switch may change if the vehicle is located near a TV transmitting tower, power station, or radio broadcasting station.

NOTE

- If either of the following problems occurs, the battery may be exhausted. Have the battery replaced by an authorised MITSUBISHI MOTORS dealer.
 - The remote control switch is operated at the correct distance from the vehicle, but the doors are not locked/unlocked in response.
 - The indicator lamp (3) is dim or does not come on.
- If your remote control switch is lost or damaged, please contact an authorised MITSUBISHI MOTORS dealer for a replacement remote control switch.
- If you wish to add remote control switch, please contact an authorised MITSUBISHI MOTORS dealer.

The following numbers of the remote control switches are available.

 - Keyless entry key: up to 4 keys
 - Keyless operation key: up to 4 keys

Procedure for replacing the remote control switch battery

E00309502312

WARNING

- Do not swallow a coin type battery.

WARNING

- **This product contains coin type battery. If a coin type battery is swallowed, it can cause severe internal burns and can lead to death.**

There have been cases where a swallowed battery has caused severe internal burns in just 2 hours.
- **Keep new and used batteries away from children.**
- **If the remote control switch case does not close securely, stop using the product and keep it away from children.**
- **If you think batteries might have been swallowed or placed inside any part of a person's body, seek immediate medical attention.**
- **To prevent an explosion or leakage of flammable liquid or gas:**
 - Do not replace the battery with an incorrect type. Replace only with the same or equivalent type.
 - Do not dispose of a battery into a fire or incinerator, or by mechanically crushing or cutting the battery.
 - Do not use, store, or take a battery any place where it may be exposed to extremely high temperature or extremely low air pressure.

Keyless entry system*

3

CAUTION

- When the remote control switch case is opened, be careful to keep water, dust, etc. out. Also, do not touch the internal components.
- Dispose of used battery according to regulations for the disposal of battery.

NOTE

- You may purchase a replacement battery at an electric appliance store.
- An authorised MITSUBISHI MOTORS dealer can replace the battery for you if you prefer.

Keyless entry key

1. Before replacing the battery, remove static electricity from your body by touching a metal grounded object.

2. Remove the screw (A) from the remote control switch.

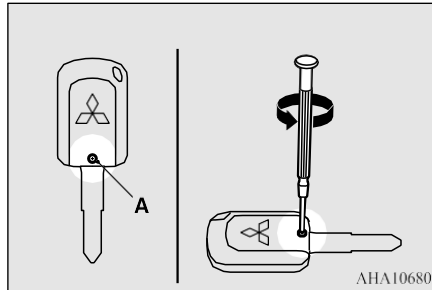

3. With the MITSUBISHI mark facing you, insert the cloth-covered tip of a straight blade (or minus) screwdriver into the notch in the remote control switch case and use it to open the case.

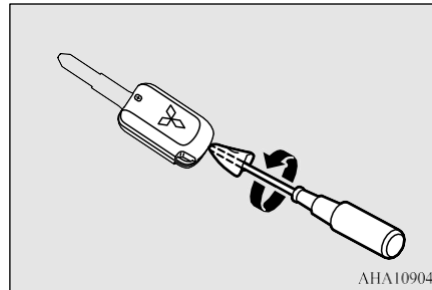

NOTE

- Be sure to perform the procedure with the MITSUBISHI mark facing you. If the MITSUBISHI mark is not facing you when you open the remote control switch case, the switches may come out.

4. Remove the used battery.
5. Install a new battery with the + side (B) up.

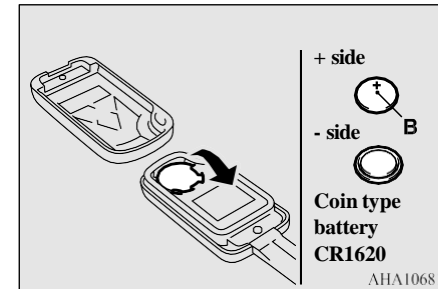

6. Close the remote control transmitter firmly.
7. Attach the screw (A) removed in step 2.
8. Check the keyless entry system to see that it works.

Keyless operation key

1. Before replacing the battery, remove static electricity from your body by touching a metal grounded object.

2. Remove the emergency key from the key. Refer to “Emergency key” on page 3-11.
3. With the MITSUBISHI mark facing you, insert the cloth-covered tip of a straight blade (or minus) screwdriver into the notch in the remote control switch case and use it to open the case.

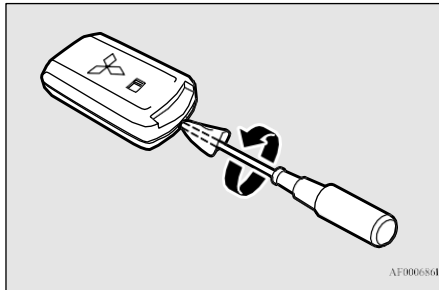

NOTE

- Be sure to perform the procedure with the MITSUBISHI mark facing you. If the MITSUBISHI mark is not facing you when you open the remote control switch case, the transmitter may come out.

4. Remove the used battery.

5. Install a new battery with the + side (A) up.

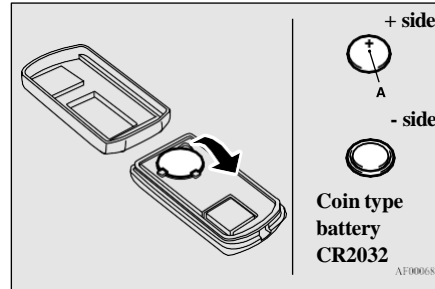

6. Close the case firmly.
7. Install the emergency key removed in step 2.
8. Check the keyless operation function to see that it works.

Keyless operation system*

E00305602706

The keyless operation system allows you to lock and unlock the doors and open the trunk lid, start the engine and change the operation mode simply by carrying the keyless operation key with you.

The keyless operation key can also be used as the keyless entry system remote control switch.

Refer to “Keyless entry system” on page 3-4.

Keyless operation system*

The driver should always carry the keyless operation key. This key is necessary for locking and unlocking the doors and opening the trunk lid, starting the engine and otherwise operating the vehicle, so before locking and leaving the vehicle, be sure to check that you have the keyless operation key.

3

NOTE

- The spare key of keyless operation keys does not have keyless operation functions equivalent to keyless operation key.
- Use the spare key when starting the engine in case of an emergency. Refer to “Keys” on page 3-2 and “Engine switch” on page 6-11.

WARNING

- People with implantable cardiac pacemakers or implantable cardiovascular-defibrillators should not go near the exterior transmitters (A) or the interior transmitters (B). The radio waves used by the keyless operation system could adversely affect implantable cardiac pacemakers or implantable cardiovascular-defibrillators.

Keyless operation system*

3

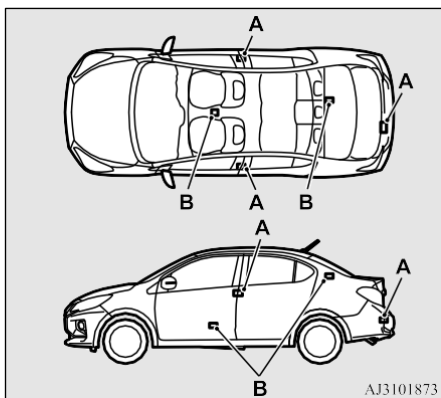

⚠ WARNING

- When using electro-medical devices other than implantable cardiac pacemakers or implantable cardiovascular-defibrillators, contact the electro-medical device manufacturer ahead of time to determine the affects of radio waves on the devices. Electromedical device operations could be affected by radio waves.

You can limit the possible operations of the keyless operation system in the following ways.

(The keyless operation system can be used as a keyless entry system.)

Please consult a MITSUBISHI MOTORS dealer for details.

- You can limit operations to locking and unlocking the doors and trunk lid.
- You can limit operations to starting the engine.
- The keyless operation system can be disabled.

NOTE

- The keyless operation key uses an ultra-weak electromagnetic wave. In the following cases, the keyless operation system may not operate properly or may be unstable.
 - When there is equipment nearby that emits strong radio waves, such as: a power station, a radio/TV broadcasting station or an airport.
 - The keyless operation system is carried together with a communications device such as a cellular phone or radio set, or with an electronic device such as a personal computer.
 - The keyless operation key is touching or covered by a metal object.
 - A keyless entry system is being used nearby.
 - When the keyless operation key battery is worn out.
 - When the keyless operation key is set down in an area with strong radio waves or noise. In such cases, use the emergency key. Refer to “To lock/unlock without using the keyless operation function” on page 3-11.

NOTE

- Because the keyless operation key receives signals in order to communicate with the transmitters in the vehicle, the battery continually wears down regardless of keyless operation key use. The battery life is 1 to 2 years, depending on usage conditions. When the battery wears out, replace the battery according to the description in this manual or have it replaced at your authorised MITSUBISHI MOTORS dealer. Refer to “Procedure for replacing the remote control switch battery” on page 3-5.
- Because the keyless operation key continually receives signals, strong radio wave reception could affect battery wear. Do not leave the key near a TV, personal computer, or other electronic device.

Operating range of the keyless operation system

E00305701986

If you are carrying the keyless operation key, enter the operating range of the keyless operation system, and press the driver’s door lock/unlock switch, or the trunk lid switch, the ID code for your key is verified.

You can only lock and unlock the doors, open the trunk lid, start the engine and change the operation mode if the ID codes of your keyless operation key and the vehicle match.

Keyless operation system*

NOTE

- If the keyless operation key battery is wearing out or there are strong electromagnetic waves or noise present, the operating range may become smaller and operation may become unstable.

Operating range for locking and unlocking the doors and opening the trunk lid

E00306201904

The operating range is approximately 70 cm from the driver's door lock/unlock switch and the trunk lid OPEN switch.

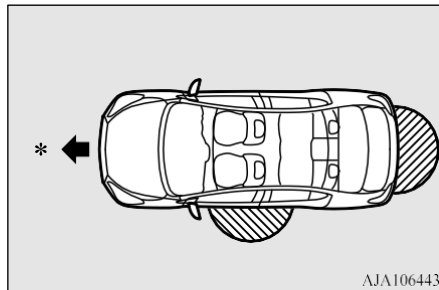

*: Forward direction
 [Hatched Area]: Operating range

NOTE

- Locking and unlocking are only possible when the door is operated while the keyless operation key is being detected.
- Operation may not be possible if you are too close to the front door, door window, or trunk lid.
- Even if the keyless operation key is within 70 cm of the driver's door lock/unlock switch or the trunk lid OPEN switch, if the key is near to the ground or high up, the system may not operate.
- If the keyless operation key is within the operating range, even someone not carrying the key can lock and unlock the doors, open the trunk lid by pressing the driver's door lock/unlock switch or the trunk lid OPEN switch.

Operating range for starting the engine and changing the operation mode

E00306301644

The operating range is the interior of the vehicle.

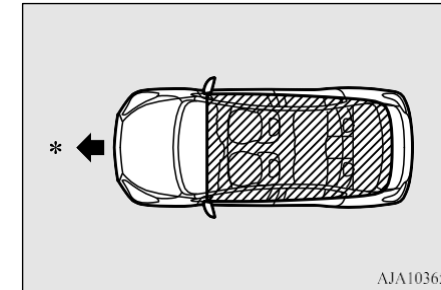

*: Forward direction
 [Hatched Area]: Operating range

NOTE

- Even if it is within the operating range, if the keyless operation key is in a small item holder such as the glove box, on top of the instrument panel, door pocket or in the trunk compartment, it may be impossible to start the engine and change the operation mode.
- If the keyless operation key is too close to the door or door window, it may be possible to start the engine or change the operation mode even when the key is outside the vehicle.

Keyless operation system*

To operate using the keyless operation function

E00305803242

3

driver's door lock/unlock switch

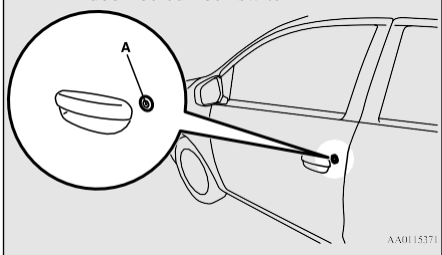

AJ0115371

Trunk lid OPEN switch

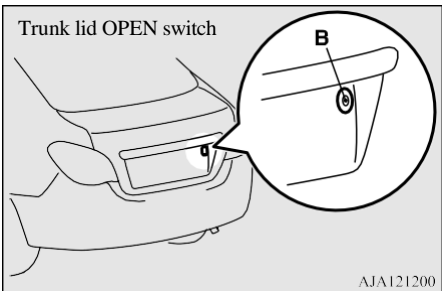

AJA121200

Locking the doors

When you are carrying the keyless operation key, if you press the driver's door lock/unlock

switch (A) within the operating range, all the doors and the trunk lid are locked.

The turn-signal lamps will blink once and the outer buzzer will sound once.

Also refer to "Locking and unlocking: Doors, Central door locks" on pages 3-16, 3-17.

Unlocking the doors and opening the trunk lid

When you are carrying the keyless operation key, if you press the driver's door lock/unlock switch (A) within the operating range, all the doors are unlocked.

If the room lamp switch is in the middle (●) position at this time, the room lamp will turn on for 15 seconds. The turn-signal lamps will blink twice and the outer buzzer will sound twice.

When you are carrying the keyless operation key, if you press and hold down the trunk lid OPEN switch (B) within operating range, the trunk lid is opened.

Also refer to "Trunk lid" on page 3-18.

If the driver's door lock/unlock switch is pressed and any of the doors is not opened within approximately 30 seconds, relocking will automatically occur.

Refer to "Locking and unlocking: Doors, Central door locks" on pages 3-16, 3-17.

NOTE

- For vehicles equipped with the mirror retractor switch, the outside rear-view mirrors automatically retract/extend when all the doors are locked/unlocked using the keyless operation function. Refer to "Starting and driving: Outside rear-view mirrors" on page 6-7.
- The keyless operation function does not operate under the following conditions:
 - The keyless operation key is inside the vehicle.
 - A door is open or ajar.
 - The operation mode is not in OFF.
- The time between unlocking and automatic locking can be adjusted. Please consult an authorised MITSUBISHI MOTORS dealer.

Operation confirmation when locking and unlocking

Operation can be confirmed as shown below. However, the room lamp will illuminate only if the room lamp switch is in the middle (●) position.

When locking: The turn-signal lamps blink once and the outer buzzer sounds once.

Keyless operation system*

When unlocking: The room lamp illuminates for approximately 15 seconds, the turn-signal lamps blink twice, and the outer buzzer sounds twice.

NOTE

- Functions can be modified as stated below. For further information, please contact your authorised MITSUBISHI MOTORS dealer.
- Activating the operation confirmation function (blinking of the turn-signal lamps) only during locking, or only during unlocking.
- Disabling the operation confirmation function (blinking of the turn-signal lamps) and outer buzzer.
- Changing the number of blinks for the operation confirmation function (blinking of the turn-signal lamps).

To lock/unlock without using the keyless operation function

E00306000165

Emergency key

E00307200470

The emergency key (A) can only be used to lock and unlock the front passenger's door. To use the emergency key, unlock the lock knob (B) and remove it from the keyless operation key (C).

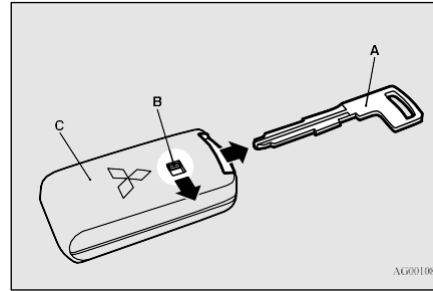

NOTE

- Only use the emergency key for emergencies. If the keyless operation key battery wears out, replace it as quickly as possible so that you can use the keyless operation key.
- The emergency key is built in the keyless operation key and spare key.
- After using the emergency key, always return it into the original position.

Locking and unlocking the front passenger's door

Turning the emergency key in the forward direction locks the door, and turning it in the rear direction unlocks the door. Also refer to "Locking and unlocking: Doors" on page 3-16.

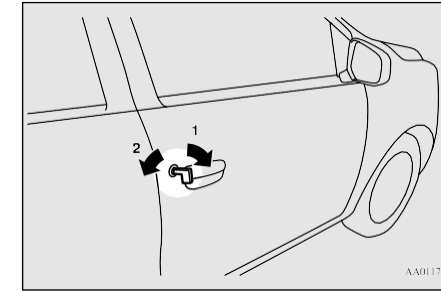

- 1- Lock
- 2- Unlock

3

Keyless operation system*

Warning activator

E00305902523

In order to prevent vehicle theft or the accidental operation of the keyless operation system, the lamp and buzzer are used to alert the driver.

3

Lamp 	Buzzer	Item	Cause	Note (Solution)
Blinks	Outer buzzer sounds 4 times. Inner buzzer sounds.	Keyless operation key take-out monitoring system	When the vehicle is parked with the operation mode in any mode other than OFF, if you close the door after opening any of the doors and take the keyless operation key out of the vehicle. Outer buzzer sounds 4 times at this time. And when the vehicle starts, inner buzzer sounds once.	<ul style="list-style-type: none"> ● If you take the keyless operation key out of the vehicle through a window without opening a door, this system does not operate. ● It is possible to change the setting to make the system operate if you take the keyless operation key out from the vehicle through a window without opening a door. For further information, please contact an authorised MITSUBISHI MOTORS dealer. ● Even if you have the keyless operation key within the engine start operating range, if the key and vehicle ID codes cannot be matched, for example due to the ambient environment or electromagnetic conditions, the warning may be activated.

Keyless operation system*

Lamp 	Buzzer	Item	Cause	Note (Solution)
Blinks	Outer buzzer sounds approximately 3 seconds	Key lock-in prevention system	When the operation mode is in OFF, you close all the doors with the keyless operation key left in the vehicle and you try to lock the doors by pressing the driver's door lock/unlock switch.	Make sure you have the keyless operation key with you before locking the doors. Even if you leave the keyless operation key inside the vehicle, it is possible that the doors will lock depending on the surrounding environment and wireless signal conditions.
Blinks	Outer buzzer sounds approximately 3 seconds	Door ajar prevention system	When the operation mode is in OFF, if you try to lock the doors by pressing the driver's door lock/unlock switch with one of the doors not completely closed.	—

3

Keyless operation system*

3

Lamp 	Buzzer	Item	Cause	Note (Solution)
Blinks	No sounds	Keyless operation system	The battery of the keyless operation key has worn out.	Replace the battery as soon as possible at an authorised MITSUBISHI MOTORS dealer.
			A power supply is not switched over from OFF because the keyless operation key in the vehicle cannot be detected. When a warning is issued to being in the vehicle, it is because the battery of the keyless operation key has worn out or the state of the surrounding radio wave is bad.	Please confirm that the keyless operation key is in the vehicle. If the key is in the vehicle, insert the slot. Starting the engine and changing the operation mode should be now possible.
			There is a fault in the keyless operation system.	If the warning lamp illuminates, please contact an authorised MITSUBISHI MOTORS dealer.
Illuminates	Inner buzzer sounds (intermittent sounds)		There is a fault in the electrical system.	Immediately stop the vehicle in a safe place and contact an authorised MITSUBISHI MOTORS dealer.
Inner buzzer sounds (continuous sounds)				
Blinks	Outer buzzer sounds approximately 3 seconds. Inner buzzer sounds approximately 1 minute.	Keyless operation key reminder	When the operation mode is in OFF with the keyless operation key left in the key slot, if you try to open the driver's door.	Remove the keyless operation key from the key slot. Refer to "Starting" on page 6-15.

Keyless operation system*

3

Lamp 	Buzzer	Item	Cause	Note (Solution)
Illuminates	Inner buzzer sounds	Steering wheel lock	There is a fault in the steering wheel lock system.	Refer to “Steering wheel lock” on page 6-14.
Blinks	Outer buzzer sounds approximately 3 seconds	Operation mode OFF reminder system	When the operation mode is in any mode other than OFF, you try to lock by using the driver’s door lock/unlock switch.	Refer to “Operation mode OFF reminder system” on page 6-13.

Lamp 	Buzzer	Item	Cause	Note (Solution)
Illuminates	No sounds	Immobilizer system	There is a fault in the electronic immobilizer (Anti-theft starting system).	Put the operation mode in OFF and then start the engine again. If the warning is not cancelled, contact an authorised MITSUBISHI MOTORS dealer.
Blinks	Inner buzzer sounds	Steering wheel lock	Steering wheel does not unlock.	Unlock the steering wheel lock following the procedure of reference page. Refer to “Steering wheel lock” on page 6-14.
Illuminates	No sounds		Steering wheel lock is abnormal.	Refer to “Steering wheel lock” on page 6-14.

Doors

Doors

E00300402363

3

CAUTION

- Make sure the doors are closed: driving with doors not completely closed is dangerous.
- Never leave children in the vehicle unattended.
- Be careful not to lock the doors while the key is inside the vehicle.

To lock or unlock with the key

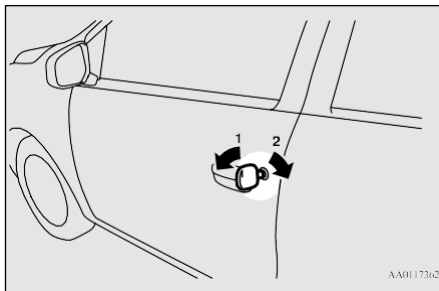

- 1- Lock
2- Unlock

To lock or unlock from inside the vehicle

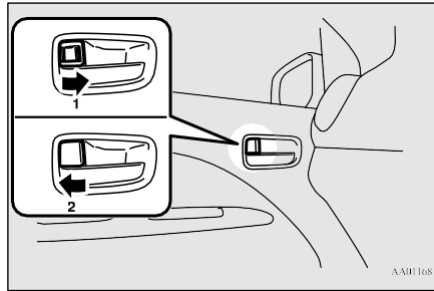

- 1- Lock
2- Unlock

NOTE

- The driver's door can be opened without using the lock knob by pulling on the inside door handle.

To lock without using the key

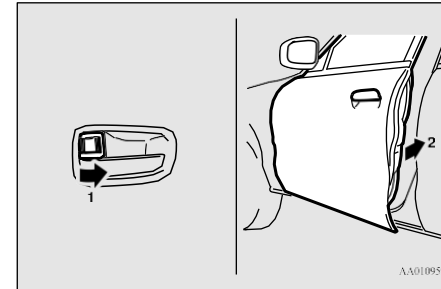

Set the inside lock knob (1) to the locked position, and close the door (2).

“Forgotten-key-prevention” mechanism*

E00300600329

If the key is in the ignition switch or the operation mode is other than OFF, when you push the lock knob forward with the driver's door open, the lock knob will automatically return to the unlocked position.

Central door locks*

Central door locks*

E00300802992

NOTE

- Repeated continuous operation between lock and unlock could activate the central door locking systems built-in protection circuit and prevent the system from operating. If this occurs, wait approximately 1 minute before operating the central door lock system.

All of the doors and the trunk lid can be locked and unlocked as described hereafter.

Driver's door with key (vehicles without keyless operation system)

Using the key on the driver's door locks or unlocks all doors.

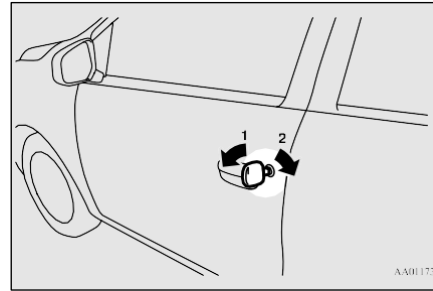

- 1- Lock
- 2- Unlock

Driver's door with inside lock knob

Using the door lock knob on the driver's door locks or unlocks all doors.

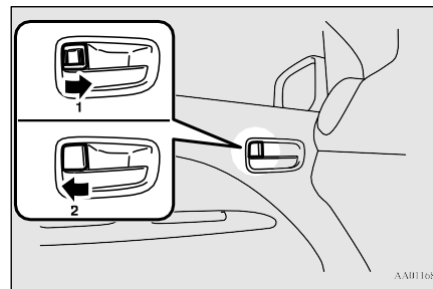

- 1- Lock

- 2- Unlock

NOTE

- Be careful not to lock the doors while the key is inside the vehicle when getting off the vehicle.

3

Using the selector lever position (CVT)

It is possible to unlock all of the doors using the selector lever by placing the selector lever in the "P" (PARK) position while the ignition switch is in the "ON" position or put the operation mode in ON.



3

“Child-protection” rear doors

NOTE

- The vehicle is shipped from the factory with a setting established such that the doors are not unlocked when the selector lever is placed in the “P” (PARK) position with the ignition switch in the “ON” position or put the operation mode in ON. If you wish to change the setting such that the doors are unlocked, please contact an authorised MITSUBISHI MOTORS dealer.

“Child-protection” rear doors

E00300902065

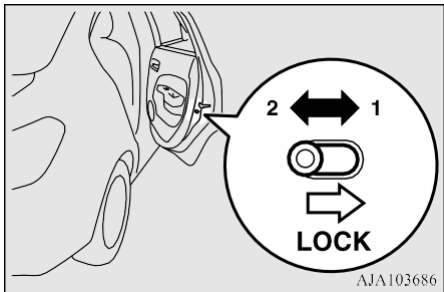

AJA103686

- 1- Lock
- 2- Unlock

Child protection helps prevent doors from being opened accidentally, especially when small children are in the rear seat.

3-18 Locking and unlocking

A lever is provided on each rear door.

If the lever is set to the locked position, the rear door cannot be opened using the inside handle.

To open the rear door while the child protection is in use, pull the outside door handle.

If the lever is set to the “Unlock” position, the child protection mechanism does not function.

CAUTION

- When driving with a child in the rear seat, please use the child protection to prevent accidental door opening which may cause an accident.

Trunk lid

E00301201765

WARNING

- The trunk cannot be opened from the inside. Be careful not to allow children to get inside the trunk. If a child got trapped inside the trunk, a serious accident could result.
- It can be dangerous to drive with the trunk lid open since carbon monoxide (CO) gas can enter the cabin. You cannot see or smell CO. It can cause unconsciousness and even death.

To open

Operation from outside the vehicle

Using the key (Vehicles with key cylinder)

Insert the key and turn it.

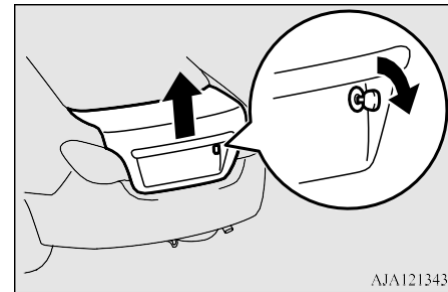

AJA121343

NOTE

- On vehicle equipped with the keyless operation system, to open the trunk lid, refer to “To operate using the keyless operation function” on page 3-10.

Operation from inside the vehicle

Pull the release lever located beside the driver's seat.

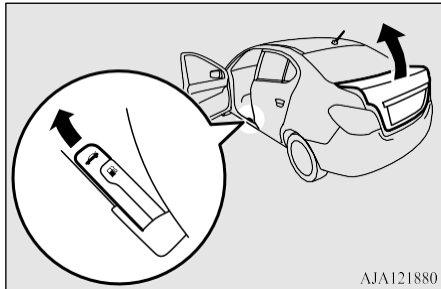

AJA121880

Using the remote control switch (Vehicles with keyless operation system)

Press the electric trunk lid switch or OPEN switch on the trunk lid. (See "Keyless operation system" on page 3-7.)

The trunk lid will pop up slightly. Lift it to open the trunk.

To close

Pull the centre portion of the trunk lid downward as illustrated. Gently slam the trunk lid from the outside so that it is completely closed. Always ensure the trunk lid is securely closed.

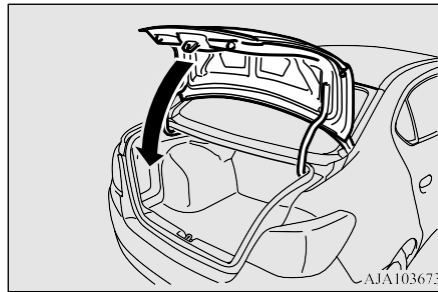

AJA103673

CAUTION

- When closing the trunk lid, always ensure your or other person's fingers cannot be caught by the trunk lid.

NOTE

- The trunk room lamp illuminates when the lid is opened and off when it is closed.
- When closing the trunk lid, if you operate other than the centre portion of the lid, it may be deformed and cannot be completely closed.

Manual window control*

Manual window control*

E00302100096

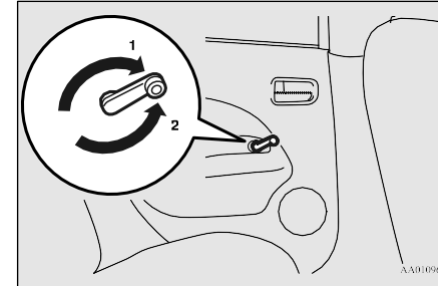

AA009640

- 1- To open
- 2- To close

3

Electric window control

E00302201629

The electric windows can only be operated with the ignition switch or the operation mode in ON.

Electric window control switch

E00302301923

Each door window opens or closes while the corresponding switch is operated.

Electric window control

3

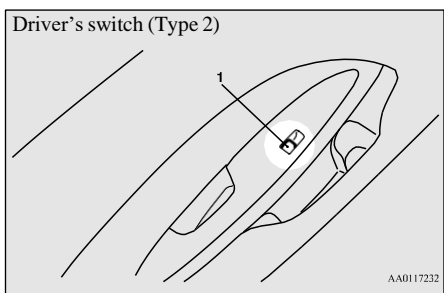
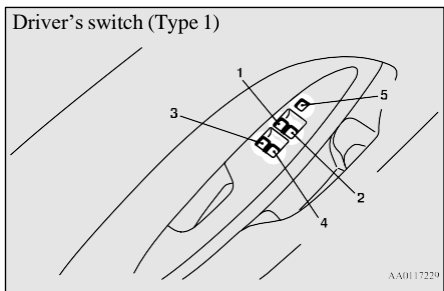

- 1- Driver's door window
- 2- Front passenger's door window
- 3- Rear left door window
- 4- Rear right door window
- 5- Lock switch

⚠ WARNING

- Before operating the electric window control, make sure that nothing is capable of being trapped (head, hand, finger, etc.).

3-20 Locking and unlocking

⚠ WARNING

- Never leave the vehicle without removing the key.
- Never leave a child (or other person who might not be capable of safe operation of the electric window control) in the vehicle alone.

Driver's switches

Type 1

The driver's switches can be used to operate all door windows. A window can be opened or closed by operating the corresponding switch.

Press the switch down to open the window, and pull up the switch to close it.

If the switch for the driver's window is fully pressed down/pulled up, the door window automatically opens/closes completely.

If you want to stop the window movement, operate the switch lightly in the reverse direction.

Type 2

Press the switch down for opening the window, and pull up the switch for closing.

Passenger's switches

The passenger's switches can be used to operate the corresponding passenger's door windows.

Press the switch down for opening the window, and pull up the switch for closing.

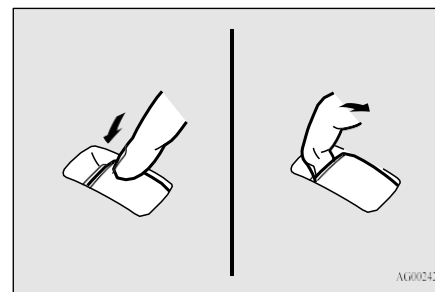

📖 NOTE

- Repeated operation with the engine stopped will run down the battery. Operate the window switches only while the engine is running.
- The rear door windows only open halfway.

Lock switch (Type 1)

E00303101306

When this switch is operated, the passenger's switches cannot be used to open or close the

Electric window control

door windows and the driver's switch cannot open or close any door windows other than the driver's door window.
To unlock, press it once again.

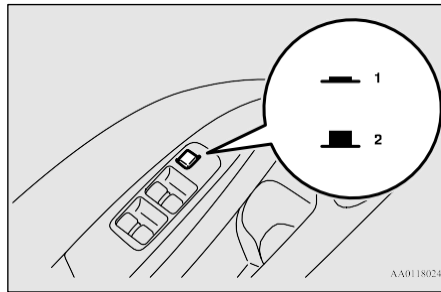

- 1- Lock
- 2- Unlock

WARNING

- A child may tamper with the switch at the risk of its hands or head being trapped in the window. When driving with a child in the vehicle, please press the window lock switch to disable the passenger's switches.

Timer function

E00302401054

The door windows can be opened or closed for 30 seconds after the engine is stopped.

However, once the driver's door or the front passenger's door is opened, the windows cannot be operated.

Safety mechanism (driver's window of Type 1 only)

E00302502065

When the door window is automatically closed by pulling up the switch fully, if a hand or head is trapped in the closing window, it will lower automatically.

Nonetheless, make sure that nobody puts their head or hand out of the window when closing the driver's door window.

The lowered window will become operational after a few seconds.

WARNING

- If the battery terminals are disconnected or the fuse for electric window is replaced, the safety mechanism will be cancelled. If a hand or head got trapped, a serious injury could result.

CAUTION

- The safety mechanism is cancelled just before the window is fully closed. This allows the window to close completely. Therefore be especially careful that no fingers are trapped in the window.

CAUTION

- The safety mechanism is deactivated while the switch is pulled up. Therefore be especially careful that fingers are not trapped in the door window opening.

3

NOTE

- The safety mechanism can be activated if the driving conditions or other circumstances cause the driver's door window to be subjected to a physical shock similar to that caused by a trapped hand or head.

- If the safety mechanism is activated 5 or more times in a row, the safety mechanism will be cancelled and the door window will not close correctly.

In such a case, the following procedure should be implemented to rectify this situation. If the window is open, repeatedly raise the driver's door window switch until that window has been fully closed. Following this, release the switch, raise the switch once again and hold it in this condition for at least 1 second, then release it. You should now be able to operate in the normal fashion.

Electric window control

3

NOTE

- If the battery terminals are disconnected or the fuse for electric window is replaced, the safety mechanism will be cancelled and the door window will not automatically open/close completely.

If the window is open, repeatedly raise the driver's door window switch until the window has been fully closed. Following this, release the switch, raise the switch once again and hold it in this condition for at least 1 second, then release it. You should now be able to operate the driver's door window in the normal fashion.

3-22 Locking and unlocking

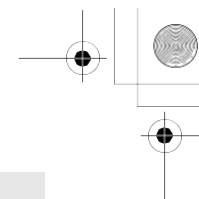
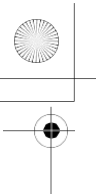

Seat and seat belts

Seat adjustment	4-2
Front seat	4-2
Rear seat	4-3
Head restraints	4-3
Seat belts.....	4-5
Pregnant women restraint.....	4-8
Seat belt pre-tensioner system and force limiter system.....	4-8
Child restraint	4-9
Seat belt inspection	4-17
Supplemental restraint system (SRS) - airbag	4-17

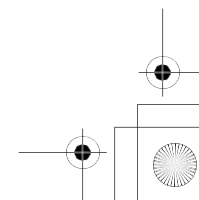
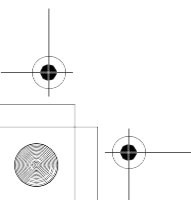

Seat adjustment

Seat adjustment

E00400302204

Adjust the driver's seat so that you are comfortable and that you can reach the pedals, steering wheel, switches etc. while retaining a clear field of vision.

4

! WARNING

- Do not attempt to adjust the seat while driving. This can cause loss of vehicle control and result in an accident. After adjustments are made, ensure the seating is locked in position by attempting to move the seat forward and rearward without using the adjusting mechanism.
- Do not allow people or children to ride in any area of your vehicle that is not equipped with seats and seat belts, and make sure that everyone travelling in your vehicle is in a seat and wearing a seat belt, or in the case of a child is strapped in a child restraint.
- To minimize the risk of personal injury in the event of a collision or sudden braking, the seatbacks should always be in the almost upright position while the vehicle is in motion. The protection provided by the seat belts may be reduced significantly when the seatback is reclined. There is greater risk that the passenger will slide under the seat belt, resulting in serious injury, when the seatback is reclined.

! WARNING

- Do not place objects under the seats. This could prevent the seat from locking securely, and it could lead to an accident. It may also cause damage to the seat or other parts.

! CAUTION

- Make sure the seat is adjusted by an adult or with adult supervision for correct and safe operation.
- Do not place a cushion or the like between your back and the seatback while driving. The effectiveness of the head restraints will be reduced in the event of an accident.
- When sliding the seats, be careful not to catch your hand or foot.

Front seat

E00400400230

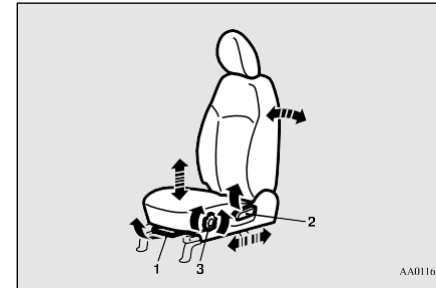

AA0116336

- 1- To adjust forward or backward
Lift the handle and adjust the seat to the desired position, and release the handle.
- 2- To recline the seatback
Pull the lever up and then lean backward to the desired position, and release the lever.
- 3- To adjust seat cushion height (driver's side only)*
Turn the dial and adjust the seat cushion height to the desired position.

CAUTION

- The reclining mechanism of the seatback is spring loaded, causing it to return to the vertical position when the lock lever is operated. When using the lever, sit close to the seatback or hold it with your hand to control its return motion.

Armrest (Driver's seat only)*

E00400901522

To adjust the armrest angle, tip the armrest forward and then raise it to the desired position.

To release the armrest angle, raise it fully rearward as shown.

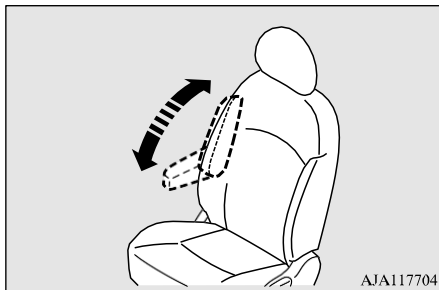

AJA117704

NOTE

- Do not stand or sit on the armrest. It could break.

Rear seat

E00401300018

Armrest*

E00401701758

To use the armrest, fold it down. To return to the original position, push it backward until it is flush with the seat.

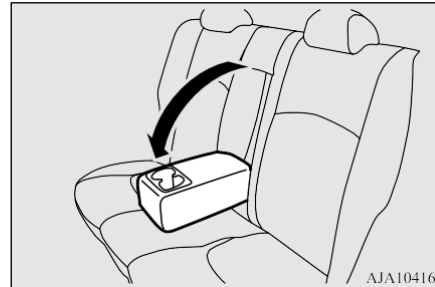

AJA104162

NOTE

- The top surface of the armrest contains a cup holder for rear seat occupants. Refer to "Cup holder" on page 7-81.

Head restraints

E00403302667

WARNING

- Driving without the head restraints in place can cause you and your passengers serious injury or death in an accident. To reduce the risk of injury in an accident, always make sure the head restraints are installed and properly positioned when the seat is occupied.
- Never place a cushion or similar device on the seatback. This can adversely affect head restraint performance by increasing the distance between your head and the restraint.
- When a person sits in the rear seat, pull up the head restraint to a height at which it locks in position. Be sure to make this adjustment before starting to drive. Serious injuries could otherwise be suffered in the result of an impact.

4

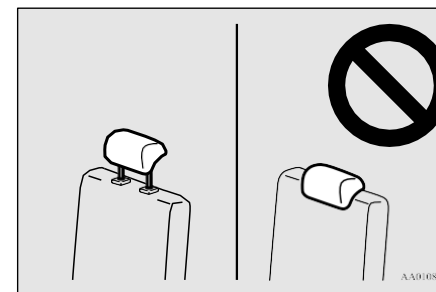

AJA008858

Head restraints

To adjust height

4

Adjust the head restraint height so that the centre of the restraint is as close as possible to ear level to reduce the chances of injury in the event of collision. Any person too tall for the restraint to reach their seated ear level, should adjust the restraint as high as possible.

To raise the head restraint, move it upward. To lower the restraint, move it downward while pushing the height adjusting knob (A) in the direction of the arrow. After adjustment, push the head restraint downward and make sure that it is locked.

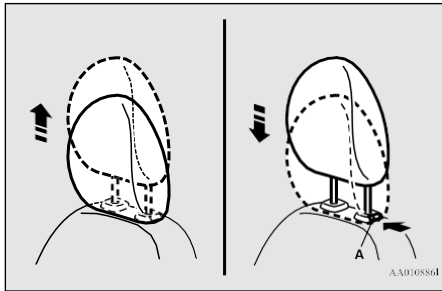

To remove

Lift the head restraint with the height adjusting knob (A) pushed in.

4-4 Seat and seat belts

To install

Confirm that the head restraint is facing the correct direction, and then insert it into the seatback while pressing the height adjusting knob (A) in the direction indicated by the arrow.

The head restraint stalk with the adjustment notches (B) must be installed in the hole with the adjusting knob (A).

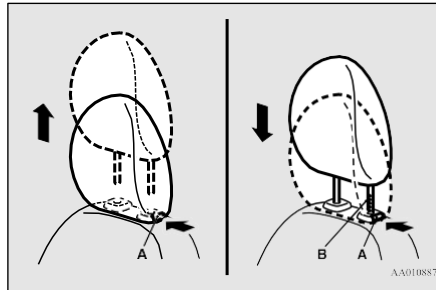

CAUTION

- Confirm that the height adjusting knob (A) is correctly adjusted as shown in the illustration, and also lift the head restraints to ensure that they do not come out of the seatback.

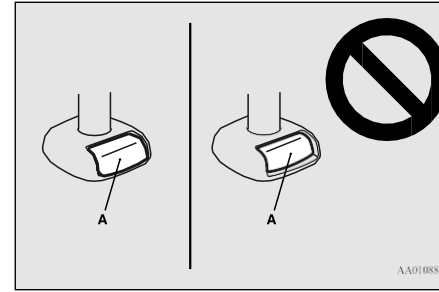

CAUTION

- The shape and size of the head restraint differs according to the seat. Always use the correct head restraint provided for the seat and do not install the head restraint in the wrong direction.

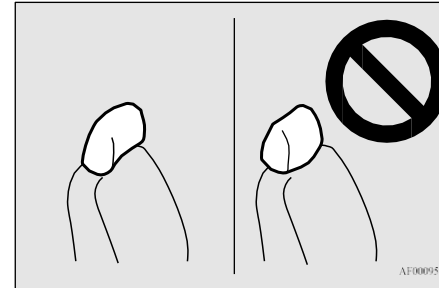

Seat belts

E00404802496

To protect you and your passengers in the event of an accident, it is the most important that the seat belts be worn correctly while driving.

The driver's and front passenger's seat belt equipped with an airbag have a pre-tensioner system.

These belts are used the same way as a conventional seat belt.

Refer to "Seat belt pre-tensioner system and force limiter system" on page 4-8.

WARNING

- Seat belts should always be worn by every adult who drives or rides in this vehicle, and by all children who are large enough to wear seat belts properly. Other children should always use proper child restraint systems.
- Always place the shoulder belt over your shoulder and across your chest. Never put it behind you or under your arm.
- One seat belt should be used by only one occupant.
It is dangerous to put a belt around a child being carried on the occupant's lap.

WARNING

- The seat belt will provide its wearer with maximum protection if the recliner seat-back is placed in fully upright position. When the seatback is reclined, there is greater risk that the passenger will slide under the belt, especially in a forward impact accident, and may be injured by the belt or by striking the instrument panel or seatbacks.
- Remove any twists when using the belt.
- No modifications or additions should be made by the user which will either prevent the seat belt adjusting devices from operating to remove slack, or prevent the seat belt assembly from being adjusted to remove slack.
- Never hold a child in your arms or on your lap when riding in this vehicle, even if you are wearing your seat belt. To do so risks severe or fatal injury to your child in a collision or sudden stop.
- Always adjust the belt to a snug fit.
- Always wear the lap portion of the belt over your hips.

WARNING

- Do not let children play with the seat belts. If children play with the seat belts by wrapping them around their bodies, the seat belt may retract and become tight. This can result in a serious injury or death, such as suffocation. This can occur even if the vehicle is parked. If the child cannot be released from the seat belt, use an appropriate tool such as a knife or scissors to cut the seat belt.

4

3-point type seat belt (with emergency locking mechanism)

E00404903146

This type of belt requires no length adjustment. Once worn, the belt adjusts itself to the movement of wearer, but in the event of a sudden or strong shock, the belt automatically locks to hold the wearer's body.

NOTE

- You can check if the belt locks by pulling it forward quickly.

To fasten

1. Pull the seat belt out slowly while holding the latch plate.

Seat belts

4

NOTE

- When the seat belts cannot be pulled out in a locked condition, pull the belts once forcefully and then return them. After that, pull the belts out slowly once again.

2. Insert the latch plate into the buckle until a “click” is heard.

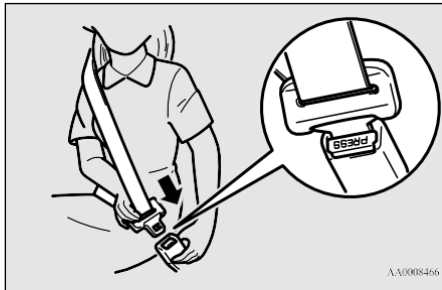

WARNING

- Never wear the lap portion of the belt across your abdomen. During accidents it can press sharply against abdomen and increase the risk of injury.
- The seat belts must not be twisted when worn.

3. Pull the belt slightly to adjust slackness as desired.

To unfasten

Hold the latch plate and push the button on the buckle.

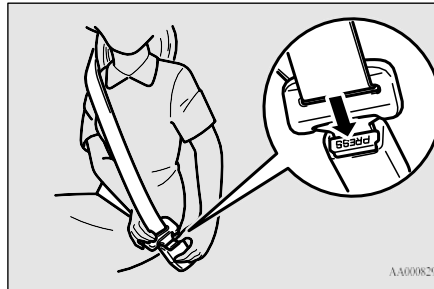

NOTE

- As the belt retracts automatically, keep the latch plate held while retracting so that the belt stows slowly. Failure to do this could damage the vehicle.

NOTE

- If the seat belt (A) or ring (B) becomes dirty, the belt may not retract smoothly. If the seat belt and ring are dirty, clean them with a mild soap or detergent solution.

Type 1

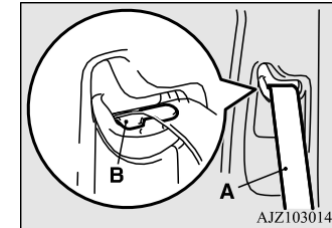

Type 2

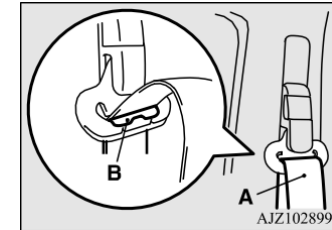

Seat belt reminder*

E00409802462

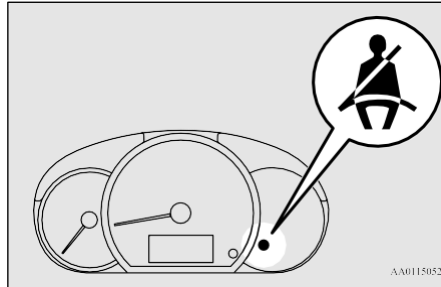

If the ignition switch is turned to the “ON” position or the operation mode is put in ON while the seat belt is not fastened, the warning lamp comes on and the tone sounds for about 6 seconds to remind the driver and the front passenger (if so equipped) to fasten the seat belt.

If the vehicle is driven with the seat belt still unfastened, the warning lamp will blink and the tone will sound intermittently until the seat belt is fastened.

NOTE

- If the seat belt subsequently remains unfastened, the warning lamp and the tone will issue further warnings each time the vehicle starts moving from a stop.

NOTE

- For the front passenger seat, the warning function works only while a person is sitting on the seat. (Vehicles with the seat belt reminder for the front passenger)
- When luggage is placed on the front passenger seat, a sensor in the seat cushion may, depending on the weight and position of the luggage, cause the warning tone to sound and the warning lamp to come on. (Vehicles with the seat belt reminder for the front passenger)

Adjustable seat belt anchor (front seats)*

E00405001759

The seat belt anchor height can be adjusted. To move the anchor, pull the lock knob (A) and slide the anchor to the desired position. Release the lock knob to lock the anchor into position.

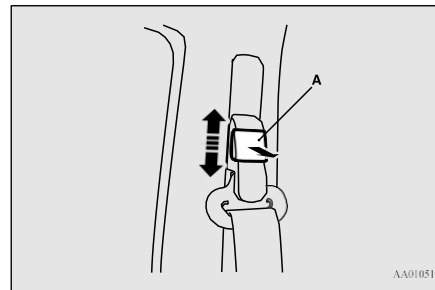

WARNING

- When adjusting the seat belt anchor, set it at a position that is sufficiently high so that the belt will make full contact with your shoulder but will not touch your neck.

4

Lap belts*

E0040510098

The lap belts should be adjusted by holding the belt and latch plate at right angles to each other, and then pulling the belt as shown in the illustration to a snug fit around the occupant.

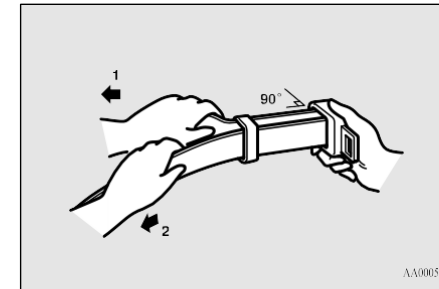

- 1- Tighten
- 2- Loosen

While holding the latch plate, insert the latch plate into the buckle until a “click” is heard.

Pregnant women restraint

Seat belt guide strap (rear seat)

E00411201020

The seat belt guide strap for the rear seat outside positions will provide added seat belt comfort.

4

When the shoulder seat belt is put through the seat belt guide strap, the seat belt guide strap better positions the seat belt webbing away from the neck and head of an occupant.

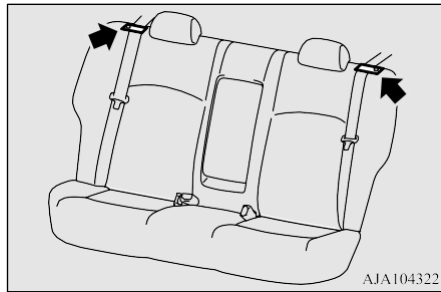

Installation

1. Unfasten the button (A) of the seat belt guide strap. Put the seat belt webbing through the seat belt guide strap and fasten the button.

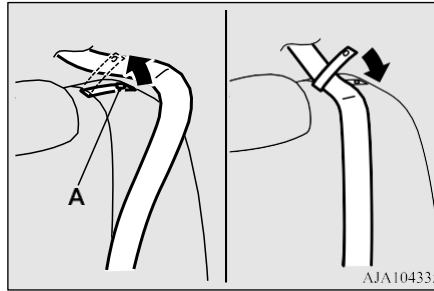

CAUTION

- Make sure the part of the seat belt webbing you inserted into the seat belt guide strap is not twisted. Twisted webbing may adversely affect seat belt performance.

2. Fasten the seat belt and make sure it fits snugly across your shoulder.

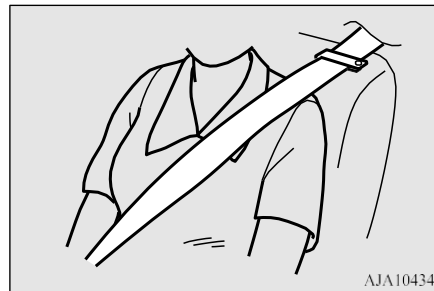

Pregnant women restraint

E00405600064

WARNING

- Seat belts work for everyone, including pregnant women. Pregnant women should use the available seat belts. This will reduce the likelihood of injury to both the woman and the unborn child. The lap belt should be worn across the thighs and as snug against the hips as possible, but not across the waist. Consult your doctor if you have any additional questions or concerns.

Seat belt pre-tensioner system and force limiter system

E00405701424

The driver's and front passenger's seat belt equipped with an airbag have a pre-tensioner system and force limiter system.

Pre-tensioner system

E00405802291

When the ignition switch or the operation mode is under the following conditions, if there is a frontal impact severe enough to injure the driver and/or front passenger, the pre-tensioner system will retract their respec-

Child restraint

tive seat belts instantaneously, thus maximizing the seat belt's effectiveness.

[Except for vehicles equipped with the keyless operation system]

The ignition switch is in the "ON" or "START" position.

[Vehicles equipped with the keyless operation system]

The operation mode is in ON.

WARNING

- To obtain the best results from your pre-tensioner seat belt, make sure you have adjusted your seat correctly and wear your seat belt properly.

CAUTION

- Any installation of audio equipment or repairs in the vicinity of the pre-tensioner seat belts or floor console must be performed by an authorised MITSUBISHI MOTORS dealer. It is important to do so because the work could affect the pre-tensioner systems.
- If you need to scrap the vehicle, please consult an authorised MITSUBISHI MOTORS dealer. It is important to do so because unexpected activation of the pre-tensioner seat belts could cause injuries.

NOTE

- The pre-tensioner seat belts will be activated if the vehicle suffers a severe frontal impact, even if the seat belts are not worn.
- The pre-tensioner seat belts are designed to work only once. After the pre-tensioner seat belts have been activated, they must be replaced by an authorised MITSUBISHI MOTORS dealer.

SRS warning lamp

E00405900083

This warning lamp is shared by the SRS airbags and the pre-tensioner seat belts.

Refer to "SRS warning lamp" on page 4-26.

Force limiter system

E00406000153

In the event of a collision, each force limiter system will effectively absorb the load applied to the seat belt to minimize the impact to the passenger.

Child restraint

E00406401835

When transporting children in your vehicle, some type of child restraint system should always be used according to the size of the

child. This is required by law in most countries.

The regulations concerning driving with children in the front seat may differ from country to country. You are advised to comply with the relevant regulations.

4

WARNING

- When possible, put children in the rear seat. Accident statistics indicate that children of all sizes and ages are safer when properly restrained in the rear seat rather than in the front seat.
- Holding a child in your arms is no substitute for a restraint system. Failure to use a proper restraint system can result in severe or fatal injury to your child.
- Each child restraint device or fixing is to be used only by one child.
- When attaching a child restraint system to the rear seat, prevent the front seatbacks from touching the child restraint system. Otherwise, the child could be seriously injured in the event of hard braking or a collision.

Child restraint

Caution for installing the child restraint on vehicle with front passenger's airbag*

E00406501676

4 The label shown here is attached on vehicles with front passenger's airbag.

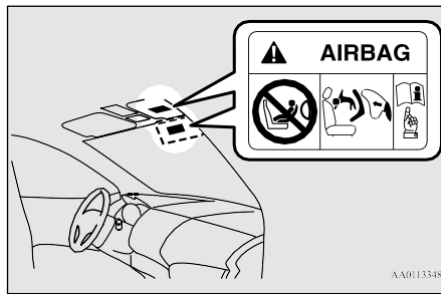

AA0113348

WARNING

- **Extreme Hazard!**
NEVER use a rearward facing child restraint on a seat protected by an ACTIVE AIRBAG in front of it, DEATH or SERIOUS INJURY to the CHILD can occur.

NOTE

- The labels may be in different positions depending on the vehicle model.

WARNING

- On vehicles with an airbag for the front passenger, a REARWARD FACING CHILD RESTRAINT must NOT be used in the front passenger seat as it places an infant too close to the passenger's airbag. The force of an inflating airbag could kill or cause serious injuries to the child. A rearward facing child restraint must only be used in the rear seat.



AHA100588

WARNING

- A FORWARD FACING CHILD RESTRAINT should be used in the rear seat whenever possible; if it must be used in the front passenger seat, adjust the seat to the most rearward position. Failure to do so could kill or cause serious injuries to the child.

Infants and small children

E00406602081

When transporting infants and small children in your vehicle, follow the instruction given below.

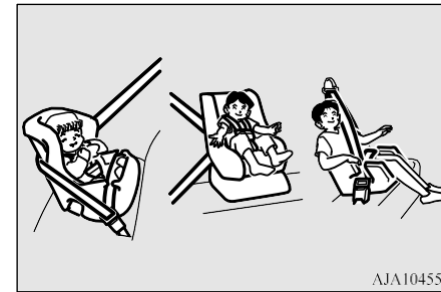

AJA104553

Instruction:

- For small infants, an infant carrier should be used. For small children whose height when seated allows the shoulder belt to lie in contact with the face or the throat, a child seat should be used.
- The child restraint system should be appropriate for your child's weight and height and properly fit the vehicle. For a higher degree of safety: THE CHILD RESTRAINT SYSTEM SHOULD BE INSTALLED IN THE REAR SEAT.

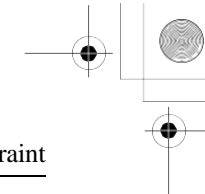
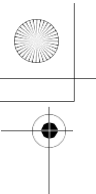

- Before purchasing a child restraint system, try installing it in the rear seat to make sure there is a good fit. Because of the location of the seat belt buckles and the shape of the seat cushion, it may be difficult to securely install some manufacturer's child restraint systems. If the child restraint system can be pulled forward or to either side easily on the seat cushion after the seat belt has been tightened, choose another manufacturer's child restraint system.

Older children

E00406700134

Children who have outgrown the child restraint system should be seated in the rear seat and wear combination lap shoulder belt. The lap portion of the belt should be snug and positioned low on the abdomen so that it is below the top of the hip-bone. Otherwise, the belt could intrude into the child's abdomen during an accident and cause injury.



⚠ WARNING

- When installing a child restraint system, refer to the instructions provided by the manufacturer of the restraint system. Failure to do so can result in severe or fatal injury to your child.
- After installation, push and pull the child restraint system back and forth, and side to side, to see that it is positively secured. If the child restraint system is not installed securely, it may cause injury to the child or other occupants in the case of accident or sudden stops.
- When the child restraint system is not in use, keep your child restraint system secured with the seat belt or remove it from the vehicle in order to prevent it from being thrown around inside the vehicle during an accident.

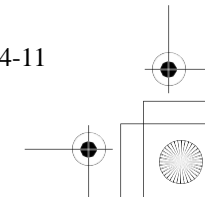
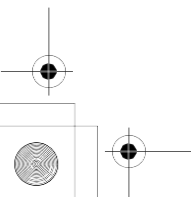

Child restraint

Suitability for various ISOFIX positions

E00411402667

4

Mass Group	Size class	Fixture	Vehicle ISOFIX positions
			Rear (Left side/Right side)
carrycot	F	ISO/L1	X
	G	ISO/L2	X
0 -Up to 10 kg	E	ISO/R1	IL
0+ -Up to 13 kg	E	ISO/R1	IL
	—	ISO/R2X	IL
	D	ISO/R2	IL
	C	ISO/R3	IL
I -9 to 18 kg	—	ISO/R2X	IL
	D	ISO/R2	IL
	C	ISO/R3	IL
	B	ISO/F2	IUF
	B1	ISO/F2X	IUF
	A	ISO/F3	IUF
II -15 to 25 kg	—	—	X
III -22 to 36 kg	—	—	X

⚠ CAUTION

- When installing a child restraint system, remove the head restraint from the seat.

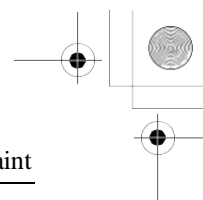
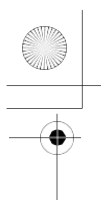

Child restraint

Definition of characters to be inserted in the above table:

- IUF- Suitable for ISOFIX forward child restraints systems of universal category approved for use in the mass group.
- IL- Suitable for ISOFIX child restraint systems of semi-universal category approved for use in the mass group.
- X- ISOFIX position not suitable for ISOFIX child restraint systems in this mass group.

4

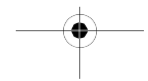
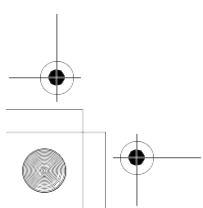

Seat and seat belts 4-13

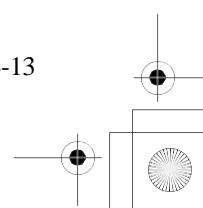

Child restraint

Suitability for various seating positions

E00406803716

4

Mass Group	Seating Position		
	Front Passenger	Rear	
		Left side/Right side	Centre
0 -Up to 10 kg	X	U	X
0+ -Up to 13 kg	X	U	X
I -9 to 18 kg	UF	U	X
II -15 to 25 kg	UF*	U*	X
III -22 to 36 kg	UF*	U*	X

*: Do not remove the head restraint when installing a booster cushion.

CAUTION

- When installing a child restraint system, remove the head restraint from the seat. However, do not remove the head restraint when installing a booster cushion (see page 4-16).
- When installing a child restraint system on the front passenger seat, adjust the front seatback angle to 2 steps rearward from the first locking position.

Definition of characters to be inserted in the above table:

- UF- Suitable for front-facing “universal” category restraints approved for use in this mass group.
- U- Suitable for “universal” category restraints approved for use in this mass group.
- X- Seat position not suitable for children in this mass group.

Installing a child restraint system to the lower anchorage (ISOFIX child restraint mountings) and tether anchorage*

E00408902349

Lower anchorage location

Your vehicle's rear seat is fitted with lower anchorages for attaching a child restraint system with ISOFIX mountings.

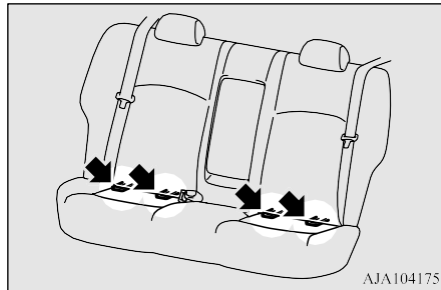

Tether anchorage locations

There are 2 attachment points on the rear shelf, located behind the top of your rear seat. These are for securing a child restraint system tether strap to each of the 2 rear seating positions in your vehicle.

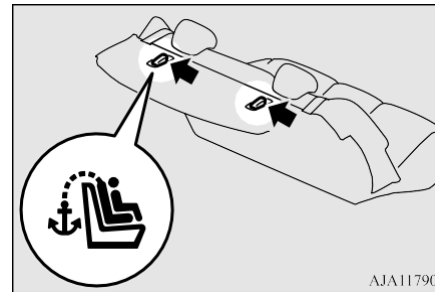

WARNING

- Child restraint anchorages are designed to withstand only those loads imposed by correctly fitted child restraints. Under no circumstances are they to be used for adult seatbelts, harnesses or for attaching other items or equipment to the vehicle.

Child restraint system with ISO-FIX mountings

The child restraint system is designed only for seats that incorporate lower anchorages. Retain the child restraint system using the lower anchorages.

It is not necessary to retain the child restraint system using the vehicle's seat belts.

4

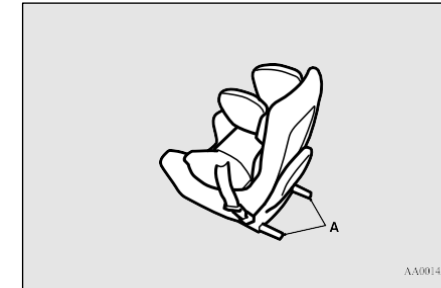

A: Child restraint system connectors

Installation:

1. Remove any foreign material in or around the connectors and ensure the vehicle seat belt is in its normal storage position.
2. Remove the head restraint from the location in which you wish to install a child restraint system.
Refer to "Head restraints" on page 4-3.

Child restraint

4

3. Open the gap a little between the seat cushion (A) and the seatback (B) with your hand to locate the lower anchorages (C).
4. Push the child restraint system's connectors (D) into the lower anchorages (C) in accordance with the instructions provided by the child restraint system's manufacturer.

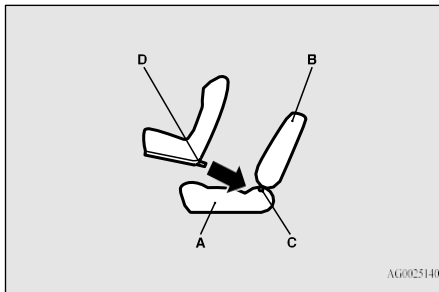

- A: Vehicle seat cushion
B: Vehicle seatback
C: Lower anchorage
D: Connector

If your child restraint system requires the use of a tether strap, fasten the tether strap in accordance with steps 5 through 6.

5. Open the cover from the tether anchor installation point by pulling it back with your hand as illustrated.

6. Latch the top tether strap hook (E) of the child restraint system to the tether anchor bracket (F) and tighten the top tether strap so it is securely fastened.

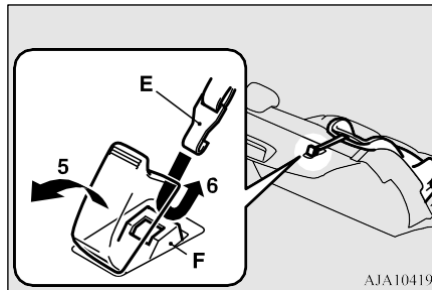

7. Push and pull the child restraint system in all directions to be sure it is firmly secured.

Installing a child restraint system to a 3-point type seat belt (with emergency locking mechanism) or a lap belt

E00407102054

Installation:

1. Put a child restraint system on the seat in which you wish to install it, and remove the head restraint from the seat. Refer to "Head restraints" on page 4-3.

CAUTION

- Do not remove the head restraint when installing a booster cushion.

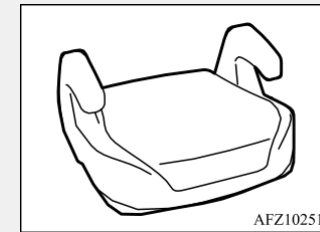

2. Route the belt through the child restraint according to the child restraint system manufacturer's instructions, then insert the latch plate into the buckle.

Seat belt inspection

3. Remove all slack of a lap belt by pulling the webbing through the belt's adjustment feature.

3-point type seat belt requires no length adjustment, remove all slack by using the locking clip.

4. Before putting the child in the restraint, push and pull the restraint in all directions to be sure it is secure. Do this before each use.

WARNING

- For some type of child restraint, the locking clip (A) should be used to help avoid personal injury during a collision or sudden manoeuvre. It must be fitted and used in accordance with the child restraint manufacturer's instructions. The locking clip must be removed when the child restraint is removed.

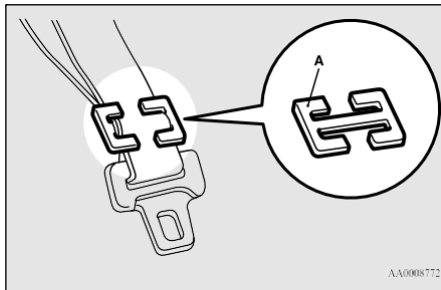

Seat belt inspection

E00406301977

Check the belts for cuts, worn or frayed webbing and for cracked or deformed metallic parts. Replace the belt assembly if defective.

WARNING

- All seat belt assemblies including retractors and attaching hardware should be inspected by an authorised MITSUBISHI MOTORS dealer after any collision. We recommend that seat belt assemblies in use during a collision be replaced unless the collision was minor and the belts show no damage and continue to operate properly.
- Do not attempt to repair or replace any part of the seat belt assemblies; this work should be done by an authorised MITSUBISHI MOTORS dealer. Failure to have an authorised MITSUBISHI MOTORS dealer perform the work could reduce the effectiveness of the belts and could result in serious injury in the event of a collision.
- Once the pre-tensioner has activated, it cannot be re-used. It must be replaced together with the retractor.

WARNING

- Do not insert any foreign objects (pieces of plastic, paper clips, buttons, etc.) in the buckle or retractor mechanism. In addition, do not modify, remove, or install the seat belt. Otherwise, the seat belt may not be able to provide adequate protection in a collision or other situation.

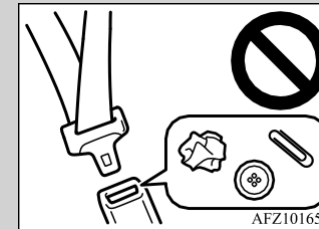

- A dirty belt should be cleaned with neutral detergent in warm water. After rinsing in water, let it dry in the shade. Do not attempt to bleach or re-dye the belts because this affects their characteristics.

Supplemental restraint system (SRS) - airbag

E00407203658

The information written in this supplemental restraint system (SRS) section contains important points concerning the driver, front passenger, side and curtain airbags. The SRS driver's airbag and the SRS front passenger's airbag (if so equipped) are

Supplemental restraint system (SRS) - airbag

designed to supplement the primary protection of the driver and front passenger side seat belt systems by providing those occupants with protection against head and chest injuries in certain moderate-to-severe frontal collisions.

4

The SRS side airbags (if so equipped) are designed to supplement properly worn seat belts and provide the driver and front passenger with protection against chest injuries in certain moderate-to-severe side impact collisions.

The SRS curtain airbags (if so equipped) are designed to supplement properly worn seat belts and provide the driver and passengers on the front seat and rear outboard seat with protection against head injuries in certain moderate-to-severe side impact collisions.

The SRS is NOT a substitute for the seat belts; for maximum protection in all types of crashes and accidents, seat belts should ALWAYS be worn by everyone who drives or rides in this vehicle.

How the supplemental restraint system works

E00407303473

The SRS includes the following components:

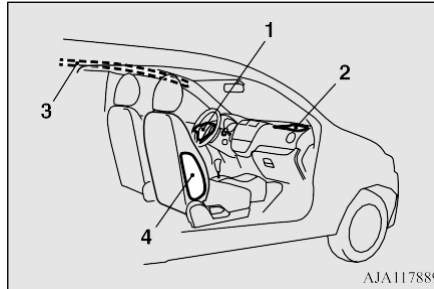

- 1- Airbag module (Driver)
- 2- Airbag module (Passenger)*
- 3- Curtain airbag modules*
- 4- Side airbag modules*

Only when the ignition switch or the operation mode is under the following conditions, the airbags will operate.

[Except for vehicles equipped with the keyless operation system]

The ignition switch is in the “ON” or “START” position.

[Vehicles equipped with the keyless operation system]

The operation mode is in ON.

The airbags deployment produces a sudden, loud noise, and releases some smoke and powder, but these conditions are not injurious, and do not indicate a fire in the vehicle. People with respiratory problems may feel some temporary irritation from chemicals used to produce the deployment; open the windows after airbag deployment, if safe to do so.

The airbags deflate very rapidly after deployment, so there is little danger of obscured vision.

⚠ CAUTION

- Airbags inflate at an extremely rapid speed. In certain situations, contact with inflating airbags can result in abrasions, light cuts, bruises, and the like.

Supplemental restraint system (SRS) - airbag

⚠ WARNING

- **IT IS VERY IMPORTANT TO BE PROPERLY SEATED.**
A driver or front passenger too close to the steering wheel or instrument panel during airbag deployment can be killed or seriously injured.
Airbags inflate very fast, and with great force.
If the driver and passengers are not properly seated and restrained, the airbags may not protect you properly, and could cause serious or fatal injuries when it inflates.
- Do not sit on the edge of the seat, or lean head or chest close to the steering wheel or instrument panel. Do not put feet or legs on or against the instrument panel.
- Place all infants and small children in the rear seat and properly restrained using an appropriate child restraint system. The rear seat is the safest for infants and children.

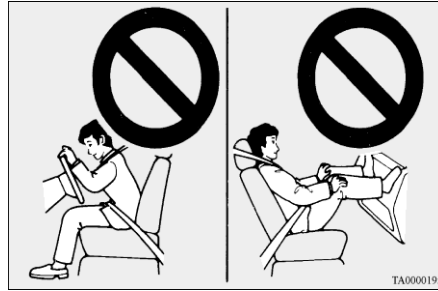

⚠ WARNING

- Infants and small children should never be unrestrained, stand up against the instrument panel or held in your arms or on your lap. They could be seriously injured or killed in a collision, including when the airbag inflates. They should be properly seated in the rear seat in an appropriate child restraint system. See the “Child restraint” section of this owner’s manual.

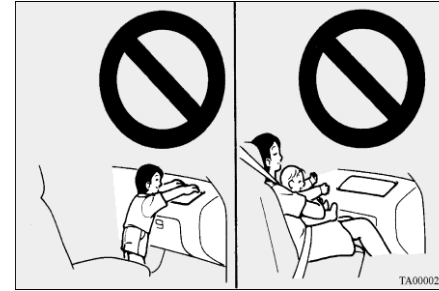

⚠ WARNING

- Older children should be seated in the rear seat, properly wearing the seat belt, with an appropriate booster seat if needed.

Supplemental restraint system (SRS) - airbag

Caution for installing the child restraint on vehicle with front passenger's airbag*

E00408802641

4 The label shown here is attached on vehicles with front passenger's airbag.

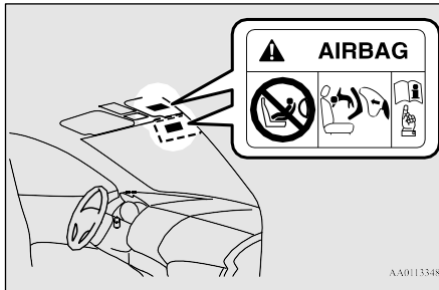

AA0113348

WARNING

- **Extreme Hazard!**
NEVER use a rearward facing child restraint on a seat protected by an ACTIVE AIRBAG in front of it, DEATH or SERIOUS INJURY to the CHILD can occur.

NOTE

- The labels may be in different positions depending on the vehicle model.

Driver's and passenger's front airbag system

E00407400864

The driver's airbag is located under the padded cover in the middle of the steering wheel. The front passenger's airbag is contained in the instrument panel above the glove box. The front passenger's airbag deploys at the same time as the driver's airbag, even if the passenger seat is not occupied.

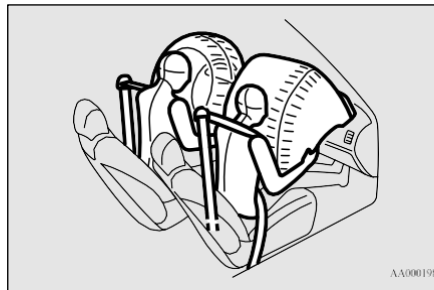

AA0001988

Deployment of front airbags

E00412501336

The front airbags ARE DESIGNED TO DEPLOY when...

The front airbags are designed to deploy when the vehicle suffers a moderate to severe frontal impact. A typical condition is shown in the illustration.

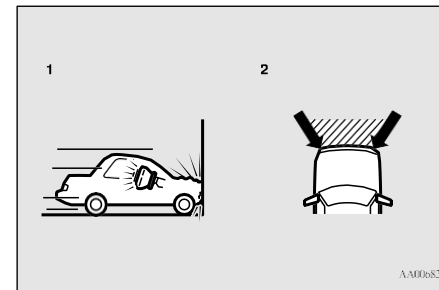

AA0068205

- 1- Head-on collision with a solid wall at speed of approximately 25 km/h or higher
- 2- Moderate to severe frontal impact within the shaded area between the arrows

The front airbags will deploy if the severity of impact is above the designed threshold level, comparable to an approximately 25

Supplemental restraint system (SRS) - airbag

km/h collision when impacting straight into a solid wall that does not move or deform. If the severity of the impact is below the above threshold level, the front airbags may not deploy. However, this threshold speed will be considerably higher if the vehicle strikes an object that absorbs the impact by either deforming or moving (for example, another stationary vehicle, pole or a guard rail). Because frontal collisions can easily move you out of position, it is important to always properly wear your seat belts. Your seat belts will help keep you in a safe distance from the steering wheel and instrument panel during the initial stages of airbag deployment. The initial stage of airbag inflation is the most forceful, and can possibly cause serious or fatal injuries. Moreover, the seat belts in your vehicle are your primary means of protection in a collision. The SRS airbags are designed to provide additional protection. Therefore, for your safety and the safety of all occupants, be sure to always properly wear your seat belts.

The front airbags MAY NOT DEPLOY when...

With certain types of frontal collisions, the vehicle's body structure is designed to absorb the shock to help protect the occupants from harm. (The vehicle body's front area may

deform significantly as it absorbs the impact.) Under such circumstances, the front airbags may not deploy irrespective of the deformation and damage to the vehicle body. Examples of some typical conditions are shown in the illustration.

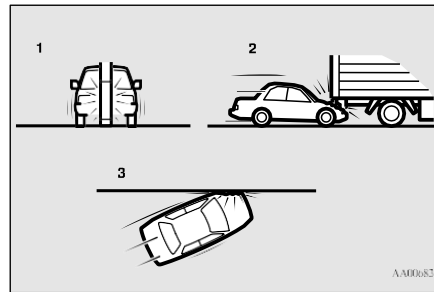

- 1- Collision with a utility pole, tree or other narrow objects
- 2- Vehicle slides under the rear body of a truck
- 3- Oblique frontal impacts

Because the front airbags do not protect the occupant in all types of frontal collisions, be sure to always properly wear your seat belts.

The front airbags ARE NOT DESIGNED TO DEPLOY when...

The front airbags are not designed to deploy in conditions where they cannot typically provide protection to the occupant. Such conditions are shown in the illustration.

4

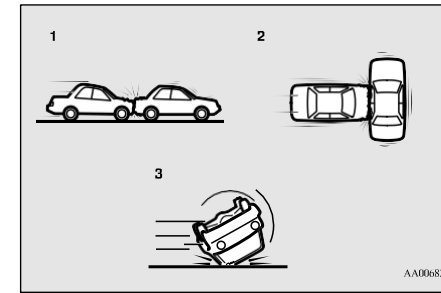

- 1- Rear end collisions
- 2- Side collisions
- 3- Vehicle rolls onto its side or roof

Because the front airbags do not protect the occupant in all types of collisions, be sure to always properly wear your seat belts.

Supplemental restraint system (SRS) - airbag

The front airbags MAY DEPLOY when...

The front airbags may deploy if the bottom of the vehicle suffers a moderate to severe impact (undercarriage damage).

4

Examples of some typical conditions are shown in the illustration.

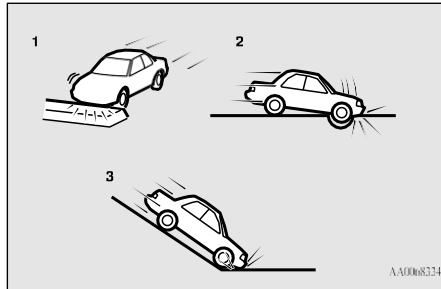

- 1- Collision with an elevated median/island or kerb
- 2- Vehicle travels over a deep hole/pothole
- 3- Vehicle drives down a steep slope and hits the ground

Because the front airbags may deploy in certain types of unexpected impacts as shown in the illustration that can easily move you out of position, it is important to always properly wear your seat belts. Your seat belts will help

4-22 Seat and seat belts

keep you in a safe distance from the steering wheel and instrument panel during the initial stages of airbag deployment. The initial stage of airbag inflation is the most forceful and can possibly cause serious or fatal injuries if you contact it at this stage.

WARNING

- Do not attach anything to the steering wheel padded cover, such as trim material, badges, etc. It might strike and injure an occupant if the airbag inflates.
- Do not set anything on, or attach anything to, the instrument panel above the glove box. It might strike and injure an occupant if the airbag inflates.

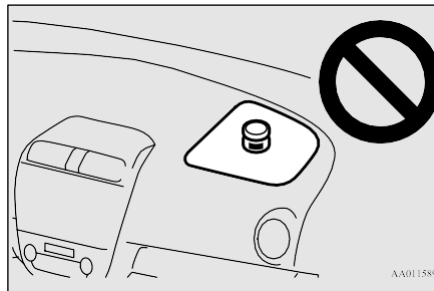

WARNING

- Do not attach accessories to, or put them in front of, the windscreen. These objects could restrict the airbag inflation, or strike and injure an occupant if the airbags inflate.
- Do not put packages, pets or other objects between the airbags and the driver or front passenger. It could affect airbag performance, or could cause injury when the airbag inflates.
- Right after the airbag inflation, several airbag system components will be hot. Do not touch them; you could be burned.
- The airbag system is designed to work only once. Once the airbags have deployed, they will not work again. They must promptly be replaced and the entire airbag system must be inspected by an authorised MITSUBISHI MOTORS dealer.

Supplemental restraint system (SRS) - airbag

Side airbag system*

E00407601948

The side airbags (A) are contained in the driver and front passenger seatbacks. The side airbag is designed to inflate only on the side of the vehicle that is impacted, even with no passenger in the front seat.

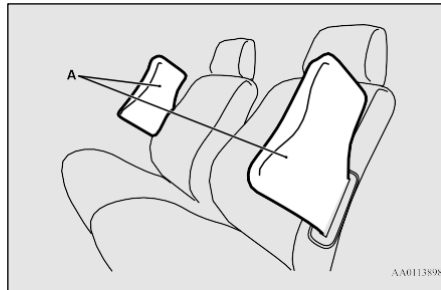

The label shown here is attached to the seatbacks with a side airbag.

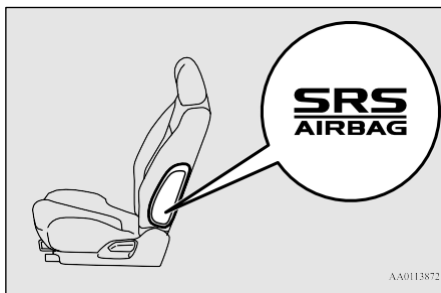

Curtain airbag system*

E00409102061

The curtain airbags are contained in the front pillars and roof side rail. The curtain airbag is designed to inflate only on the side of the vehicle that is impacted, even with no passenger in the front seat or rear seat.

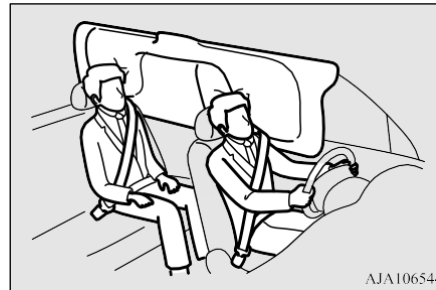

Deployment of side airbags and curtain airbags

E00407702744

The side airbags and curtain airbags ARE DESIGNED TO DEPLOY when...

4

The side airbags and curtain airbags are designed to deploy when the vehicle suffers a moderate to severe side impact to the middle of the passenger compartment. The typical condition is shown in the illustration.

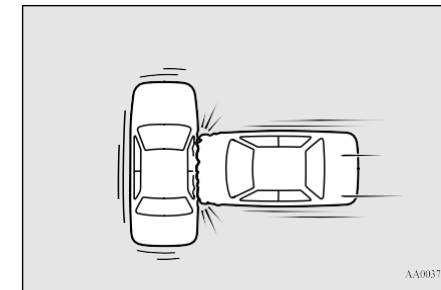

The seat belts in your vehicle are your primary means of protection in a collision. The SRS side airbags and curtain airbags are designed to provide additional protection. Therefore, for your safety and the safety of all

Supplemental restraint system (SRS) - airbag

occupants, be sure to always properly wear your seat belts.

The side airbags and curtain airbags MAY NOT DEPLOY when...

4

With certain types of side collisions, the vehicle's body structure is designed to absorb the shock to help protect the occupants from harm. (The vehicle body's side area may deform significantly as it absorbs the impact.) Under such circumstances, the side airbags and curtain airbags may not deploy irrespective of the deformation and damage to the vehicle body. Examples of some typical conditions are shown in the illustration.

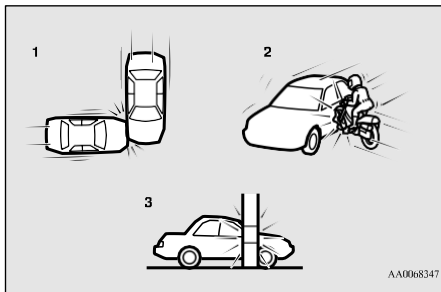

- 1- Side impacts in an area away from the passenger compartment
- 2- Motorcycle or other similar small vehicle collides with the side of vehicle

- 3- Collision with a utility pole, tree or other narrow object

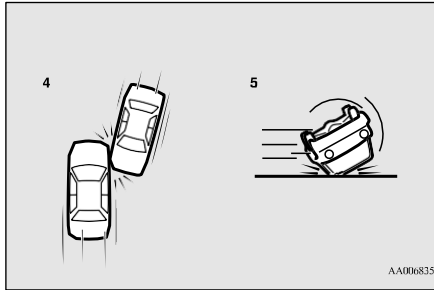

- 4- Oblique side impacts
- 5- Vehicle rolls onto its side or roof

Because the side airbags and curtain airbags do not protect the occupant in all types of side collisions, be sure to always properly wear your seat belts.

The side airbags and curtain airbags ARE NOT DESIGNED TO DEPLOY when...

The side airbags and curtain airbags are not designed to deploy in conditions where they cannot usually provide protection to the occupant. Typical conditions are shown in the illustration.

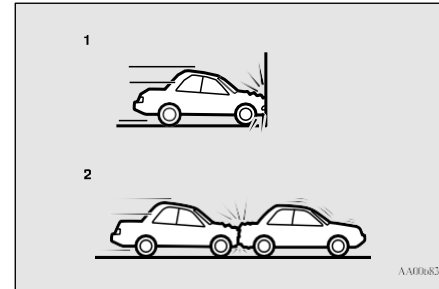

- 1- Head-on collisions
- 2- Rear end collisions

Because the side airbags and curtain airbags do not protect the occupant in all types of collisions, be sure to always properly wear your seat belts.

Supplemental restraint system (SRS) - airbag

⚠ WARNING

- The side airbags and curtain airbags are designed to supplement the driver and passenger seat belts in certain side impacts. Seat belts should always be worn properly, and the driver and passenger should sit well back and upright without leaning against the window or door.
- The side airbag and curtain airbag inflate with great force. The driver and passenger should not put their arms out the window, and should not lean against the door, in order to reduce risk of serious or possible fatal injury from the deploying side airbag and curtain airbag.



⚠ WARNING

- Do not allow any rear seat occupant to hold onto the seatback of either front seat, in order to reduce risk of injury from the deploying side airbags. Special care should be taken with children.
- Do not place any objects near or in front of the seat-back of either front seat. They could interfere with proper side airbag inflation, and also could cause injury if thrown free by side airbag deployment.
- Do not place stickers, labels or additional trim on the seatback of either front seat. They could interfere with proper side airbag inflation.
- Do not install seat covers on seats with side airbags. Do not re-cover seats that have side airbags. This could interfere with proper side airbag inflation.
- Do not attach a microphone (A) or any other device or object around the part where the curtain airbags (B) activate such as on the windscreen, side door glass, front and rear pillars and roof side or assist grips. When the curtain airbags inflate, the microphone or other device or object will be hurled with great force or the curtain airbags may not activate correctly, resulting in death or serious injury.

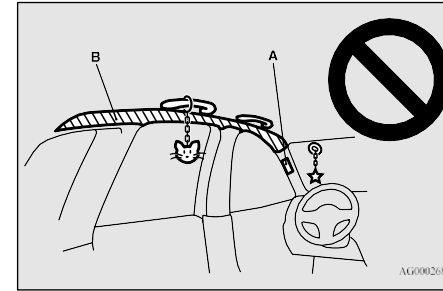

⚠ WARNING

- Never install a rearward facing child restraint in the front passenger seat. A forward facing child restraint should be used in the rear seat whenever possible. If a forward facing child restraint must be used in the front passenger seat, adjust the seat to the most rearward position, and use care to ensure that the child stays in the child restraint and away from the door.
- Do not allow the child to lean against or close to the door even if the child is seated in a child restraint system. The child's head should also not be leaned against or be close to the area where the side airbags and curtain airbags are located. It is dangerous if the side airbags and curtain airbags inflate. Failure to follow all of these instructions could lead to serious or fatal injury to the child.

Supplemental restraint system (SRS) - airbag

⚠ WARNING

- We recommend work around and on the side airbags and curtain airbags system to be done by an authorised MITSUBISHI MOTORS dealer.

4**SRS warning lamp**

E00407802918

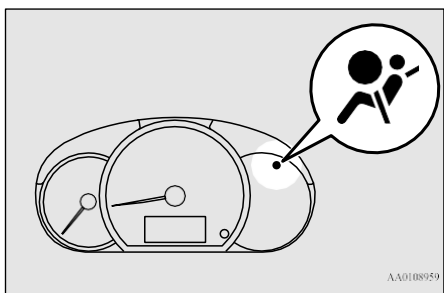

AA0108959

There is a supplemental restraint system (“SRS”) warning lamp on the instrument panel. The system checks itself every time the ignition switch is turned to the “ON” position or the operation mode is put in ON. The SRS warning lamp will come on for several seconds and then go out. This in normal and means the system is working properly.

If there is a problem involving one or more of the SRS components, the warning lamp will come on and stay on.

The SRS warning lamp is shared by the SRS airbag and the seat belt pre-tensioner system.

⚠ WARNING

- If any of the following conditions occur, there may be a problem with the SRS airbags and/or seat belt pre-tensioners, and they may not function properly in a collision or may suddenly activate without a collision:

- Even when the ignition switch or the operation mode is in ON, the SRS warning lamp does not come on or it remains on.
- The SRS warning lamp comes on while driving.

The SRS airbags and seat belt pre-tensioners are designed to help reduce the risk of serious injury or death in certain collisions.

If either of the above conditions occurs, immediately have your vehicle checked by an authorised MITSUBISHI MOTORS dealer.

SRS servicing

E00407902919

⚠ WARNING

- Any maintenance performed on or near the components of the SRS must be performed only by an authorised MITSUBISHI MOTORS dealer. Do not permit anyone else to do service, inspection, maintenance or repair on any SRS components or wiring; similarly, no part of the SRS should ever be handled or disposed of by anyone except an authorised MITSUBISHI MOTORS dealer. Improper work on the SRS components or wiring could result in inadvertent deployment of the airbags, or could render the SRS inoperative; either situation could result in serious injury.
- Do not modify your steering wheel, seat belt retractor or any other SRS components. For example, replacement of the steering wheel, or modifications to the front bumper or body structure can adversely affect SRS performance and lead to possible injury.
- If your vehicle has received any damage, you should have the SRS inspected by an authorised MITSUBISHI MOTORS dealer to ensure it is in proper working order.

Supplemental restraint system (SRS) - airbag

⚠ WARNING

- On vehicles with the side airbag, do not modify your front seats, centre pillar and centre console.
It can adversely affect SRS performance and lead to possible injury.
- If you found any tear scratch, crack or damage to the portion of the airbags, you should have the SRS inspected by an authorised MITSUBISHI MOTORS dealer.

📖 NOTE

- If your vehicle has to be scrapped, do this in line with local legislation and contact an authorised MITSUBISHI MOTORS dealer to safely dismantle the airbag system.

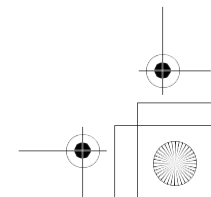
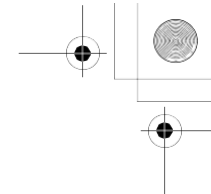
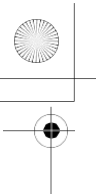

Handwriting practice area with ten horizontal dashed lines.

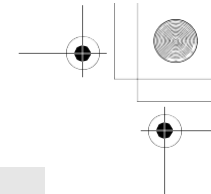
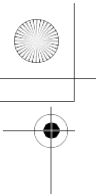

Instruments and controls

Instruments	5-2
Multi-information display	5-2
Indicator and warning lamps	5-12
Indicator lamps	5-13
Warning lamps	5-14
Combination headlamps and dipper switch	5-17
Headlamp levelling switch*	5-21
Turn-signal lever	5-22
Hazard warning flasher switch	5-22
Fog lamp switch*	5-23
Wiper and washer switch	5-24
Rear window demister switch	5-28
Horn switch	5-29

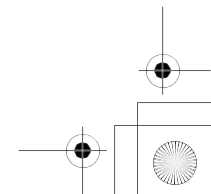
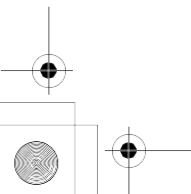

Instruments

Instruments

E00500102779

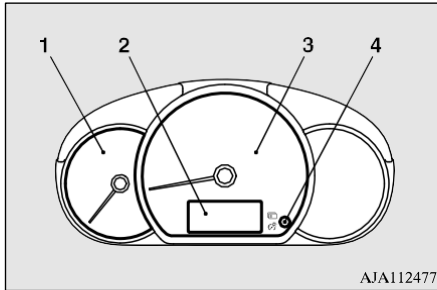

AJA112477

5

1- Tachometer

The tachometer indicates the engine speed (r/min). The tachometer can help you obtain more economical driving and also warns you of excessive engine speeds (Red zone).

- 2- Multi-information display → P.5-2
- 3- Speedometer (km/h or mph + km/h)
- 4- Multi-information display switch

CAUTION

- When driving, watch the tachometer to make sure that the engine speed indication does not rise into the red zone (excessive engine rpm).

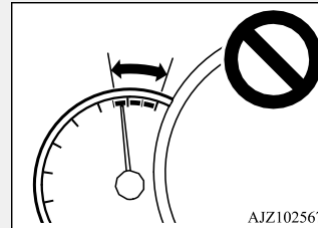

AJZ102567

Multi-information display

E00519903552

Always stop the vehicle in a safe place before operating.

The following information is included on the multi-information display: odometer, tripmeter, meter illumination control, service reminder, fuel remaining, selector lever position, driving range, average fuel consumption, etc.

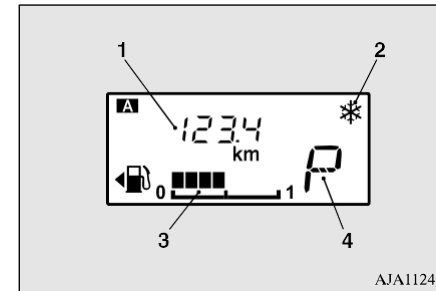

AJA112493

- 1- Information display → P.5-4
- 2- Frozen road warning* → P.5-7
- 3- Fuel remaining display → P.5-7
- 4- Selector lever position display* → P.6-28

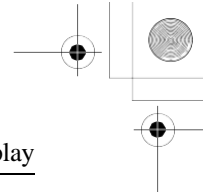
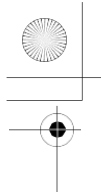

Multi-information display

NOTE

- When the ignition switch or the operation mode is OFF, the selector lever position display, fuel remaining display and frozen road warning are not displayed.

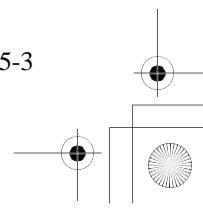
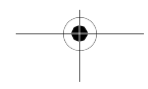
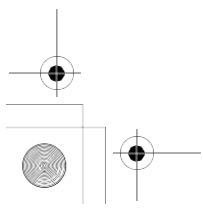

Multi-information display

Information display

E00528201586

Each time you lightly press the multi-information display switch (A), the display switches in the following order.

5

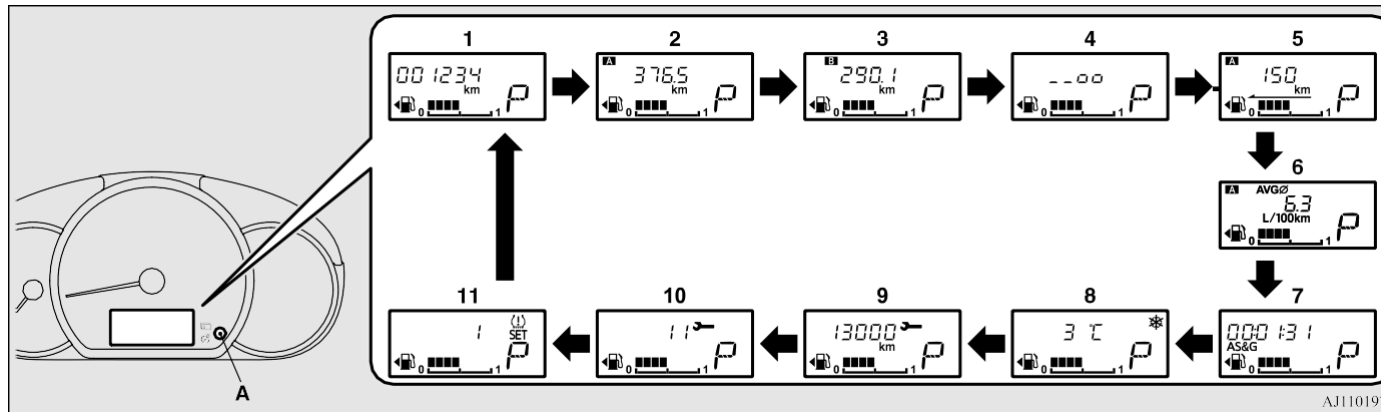

AJ1101970

- | | |
|---------------------------------------|---|
| 1- Odometer | 7- Auto Stop & Go (AS&G) monitor* → P.5-6 |
| 2- Tripmeter A | 8- Outside temperature display* → P.5-6 |
| 3- Tripmeter B | 9- Service reminder (distance) → P.5-7 |
| 4- Meter illumination control → P.5-5 | 10- Service reminder (month) → P.5-7 |
| 5- Driving range display → P.5-5 | 11- Tyre pressure monitoring system display* → P.6-48 |
| 6- Average fuel consumption display | |

NOTE

- When the ignition switch or the operation mode is OFF, the driving range display, average fuel consumption display, outside temperature display and tyre pressure monitoring system display are not displayed.
- While driving, the service reminder is not displayed even if you operate the multi-information display switch.
- When the position lamps are not illuminated, the meter illumination control is not displayed even if you operate the multi-information display switch.

Odometer

E00527800067

The odometer indicates the distance travelled.

Tripmeter

E00527900042

The tripmeter indicates the distance travelled between two points.

Example usage of tripmeter **A** and tripmeter **B**

It is possible to measure two currently travelled distances, from home using tripmeter **A** and from a particular point on the way using tripmeter **B**.

To reset the tripmeter

To return the display to 0, hold down the multi-information display switch for about 1 second or more. Only the currently displayed value will be reset.

Example

If tripmeter **A** is displayed, only tripmeter **A** will be reset.

NOTE

- Both tripmeters **A** and **B** can count up to 9999.9 km. When a tripmeter goes past 9999.9 km, it returns to 0.0 km.
- When disconnecting the battery terminal, the memories of tripmeter display **A** and display **B** are erased, and their displays return to 0.0 km.

Meter illumination control

E00537901260

Turn the position lamps on and press the multi-information display switch (2), there is a sound and the brightness changes.

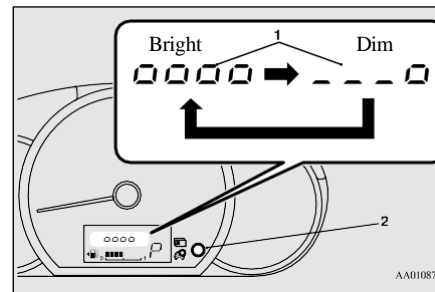

- 1- Brightness level
- 2- Multi-information display switch

Multi-information display

NOTE

- When the position lamps are illuminated, you can adjust to 8 levels.
- Each time you reduce two brightness levels, the segment display of the brightness level decreases one by one.
- The brightness level of the instruments is stored when the ignition switch is turned to the "LOCK" position or the operation mode is put in OFF.
- If you press and hold the switch for longer than about 1 second, the brightness automatically scrolls through its different levels, and stops scrolling when you release the switch. Select your desired level of brightness.
- On vehicles equipped with the automatic lamp control, the meter illumination control display are not displayed when it is bright outside the vehicle and the ignition switch or the operation mode is ON.

5

Driving range display

E00538000014

This displays the approximate driving range (how many more kilometres or miles you can drive). When the driving range falls below approximately 50 km (30 miles), "---" is displayed.

Multi-information display

5

NOTE

- The driving range is determined based on the fuel consumption data. This may vary depending on the driving conditions and habits. Treat the distance displayed as just a rough guideline.
- When you refuel, the driving range display is updated. However, if you only add a small amount of fuel, the correct value will not be displayed. Fill with a full tank whenever possible.
- On rare occasions, the value displayed for the driving range may change if you are parked on an extremely steep incline. This is due to the movement of fuel in the tank and does not indicate any malfunction.
- The display setting can be changed to the preferred units (km or miles). Refer to “Changing the function settings” on page 5-9.

Average fuel consumption display

E00531200017

This displays the average fuel consumption from the last reset to the present time. The reset mode conditions for the average fuel consumption display can be switched between “Auto reset” and “Manual reset”. For information on how to change the average fuel consumption display setting, refer to

5-6 Instruments and controls

“Changing the function settings” on page 5-9.

NOTE

- The average fuel consumption display can be reset separately in both auto reset mode and manual reset mode.
- “---” is displayed when the average fuel consumption cannot be measured.
- The initial (default) setting is “Auto reset mode”.
- The average fuel consumption will depend on the driving conditions (road conditions, how you drive, etc.). The displayed fuel consumption may vary from the actual fuel consumption. Treat the fuel consumption displayed as just a rough guideline.
- The memory of the manual reset mode or auto reset mode for the average fuel consumption display is erased if the battery is disconnected.
- The display setting can be changed to the preferred units {km/L, L/100 km, mpg}. Refer to “Changing the function settings” on page 5-9.

Auto Stop & Go (AS&G) monitor*

E00531101068

The accumulated time the engine has been stopped by Auto Stop & Go (AS&G) system is displayed.

Refer to “Auto Stop & Go (AS&G) system” on page 6-20.

NOTE

- When the ignition switch or the operation mode is ON again, the accumulated time will be reset.

Outside temperature display*

E00533501112

This displays the temperature outside the vehicle.

NOTE

- The display setting can be changed to the preferred units (°C or °F). Refer to “Changing the function settings” on page 5-9.
- Depending on factors such as the driving conditions, the displayed temperature may vary from the actual outside temperature.

Frozen road warning*

E00533401094

If the outside air temperature drops below approx. 3°C (37 °F), the alarm sounds and the outside air temperature warning symbol (A) flashes for about 10 seconds.

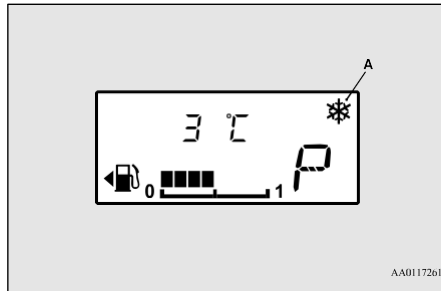

AA0117261

CAUTION

- There is a danger the road might be icy, even when this symbol is not flashing, so please take care when driving.

Fuel remaining display

E00522200558

The fuel remaining display indicates the fuel level in the fuel tank when the ignition switch or the operation mode is ON.

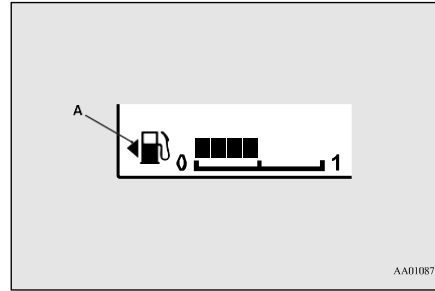

AA0108757

- 1- Full
- 0- Empty

NOTE

- It may take several seconds to stabilise the display after refilling the tank.
- If fuel is added with the ignition switch or the operation mode is ON, the fuel gauge may incorrectly indicate the fuel level.
- The fuel lid mark (A) indicates that the fuel tank filler door is located on the left side of the vehicle.

Fuel remaining warning display

E00522402192

If the remaining fuel level is approximately 6.5 litres or less (one segment displayed) when the ignition switch is turned to the “ON” position or the operation mode is changed to ON, the last segment of the fuel

Multi-information display

gauge flashes. If the remaining fuel level is reduced further, the last segment of the fuel gauge goes out, “” and the bar graph flash.



AA0108760

NOTE

- On inclines or curves, the display may be incorrect due to the movement of fuel in the tank.

CAUTION

- Do not drive with an extremely low fuel level; running out of fuel could cause damage to the catalytic converter.

Service reminder

E00522501040

Displays the approximate time until the next periodic inspection that MITSUBISHI

Multi-information display

MOTORS recommends “---” is displayed when the inspection time has arrived. The spanner mark indicates the periodic inspection.

5

NOTE

- Depending on the vehicle specifications, the displayed time until the next periodic inspection may differ from that of MITSUBISHI MOTORS recommends. In addition, the display settings for the next periodic inspection time can be modified.

To modify the display settings, have it adjusted at an authorised MITSUBISHI MOTORS dealer. For more details, contact an authorised MITSUBISHI MOTORS dealer.

Distance

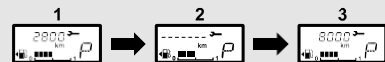

Month

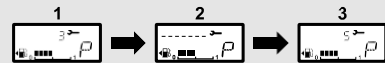

AA0108773

1. Displays the time until the next periodic inspection.

NOTE

- The distance is shown in units of 100 km. The time is shown in units of months.

2. This informs you that a periodic inspection is due. Please consult an authorised MITSUBISHI MOTORS dealer.
3. After your vehicle is inspected at an authorised MITSUBISHI MOTORS dealer, it displays the time until the next periodic inspection.

To reset

The “---” display can be reset while the ignition switch or the operation mode is in OFF.

1. When you lightly press the multi-information display switch a few times, the information display switches to the service reminder display.

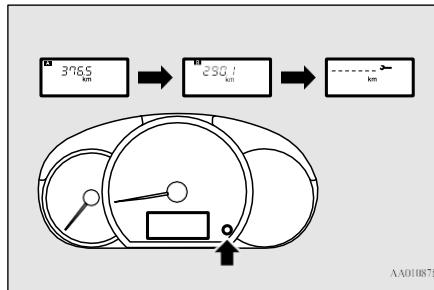

AA0108780

2. Press and hold the multi-information display switch for about 1 second or more to make the spanner mark start flashing. (If there is no operation for about 10 seconds with flashing, the display will revert to its original indication.)
3. Lightly press the multi-information display switch while the icon is flashing to change the display from “---” to “cLEAR”. After this, the time until the next periodic inspection will be displayed.

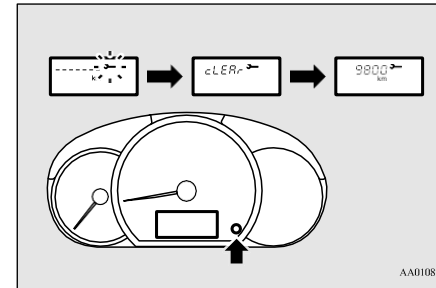

AA0108799

CAUTION

- The customer is responsible for making sure that periodic inspection and maintenance are performed. Inspections and maintenance must be performed to prevent accidents and malfunctions.

NOTE

- “---” display cannot be reset when the ignition switch or the operation mode is in ON.
- When “---” is displayed, after a certain distance and a certain period of time, the display is reset and the time until the next periodic inspection is displayed.
- If you accidentally reset the display, consult an authorised MITSUBISHI MOTORS dealer.

Changing the function settings

E00522702007

The average fuel consumption reset mode, fuel consumption unit and temperature unit setting can be modified as desired, when the ignition switch or the operation mode is ON.

CAUTION

- The driver should not operate the display while the vehicle is in motion.
- When operating the system, stop the vehicle in a safe area.

Changing the reset mode for average fuel consumption

E00522902067

The mode conditions for the average fuel consumption display can be switched between “Auto reset” and “Manual reset”.

1. When you lightly press the multi-information display switch a few times, the information display switches to the driving range display.

Refer to “Information display” on page 5-4.

2. Each time you press the multi-information display switch for 1 second or more on driving range display, you can switch reset mode for average fuel consumption. (A: Auto reset mode, B: Manual reset mode)

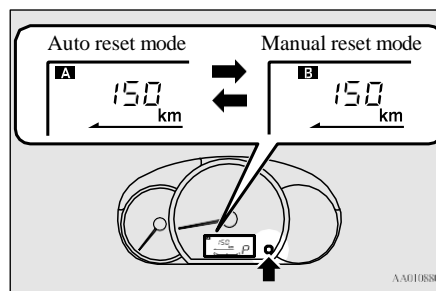
**Manual reset mode**

- When the average fuel consumption is being displayed, if you hold down the multi-information display switch, the average fuel consumption displayed at that time is reset.
- When the following operation is performed, the mode setting is automatically switched from manual to auto. [Except for vehicles equipped with the keyless operation system] Turn the ignition switch from the “ACC” or “LOCK” position to the “ON” position. [For vehicles equipped with the keyless operation system] Change the operation mode from ACC or OFF to ON.

Switching to auto occurs automatically. If switching to manual mode is done, however, the data from the last reset is displayed.

Auto reset mode

- When the average fuel consumption is being displayed, if you hold down the multi-information display switch, the average fuel consumption displayed at that time are reset.

Multi-information display

5

- When the engine switch or the operation mode is in the following conditions, the average fuel consumption display is automatically reset.
[Except for vehicles equipped with the keyless operation system]
The ignition switch is in the “ACC” or “LOCK” position for about 4 hours or longer.
[For vehicles equipped with the keyless operation system]
The operation mode is in ACC or OFF for about 4 hours or longer.

NOTE

- The average fuel consumption display can be reset separately for the auto reset mode and for the manual reset mode.
- The memory of the manual reset mode or auto reset mode for the average fuel consumption display is erased if the battery is disconnected.
- The initial (default) setting is “Auto reset mode”.

Changing the fuel consumption display unit

E00523001781

The display unit for fuel consumption can be switched. The distance and amount units are

also switched to match the selected fuel consumption unit.

1. When you lightly press the multi-information display switch a few times, the information display switches to the average fuel consumption display.
Refer to “Information display” on page 5-4.
2. Press and hold the multi-information display switch for about 5 seconds or more until buzzer sound is heard twice.
3. Press and hold the multi-information display switch to switch in sequence from “km/L” → “L/100 km” → “mpg” → “km/L”.

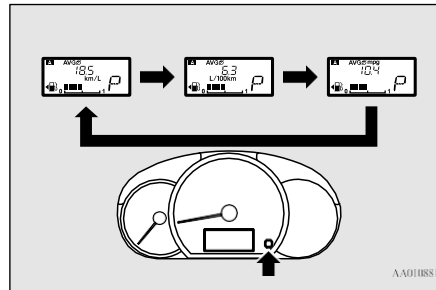

NOTE

- The display units for the driving range, the average fuel consumption are switched, but the units for the indicating needle (speedometer), the odometer, the tripmeter and the service reminder will remain unchanged.
- The memory of the unit setting is erased if the battery is disconnected, and it returns automatically to factory setting.

The distance units is also switched in the following combinations to match the selected fuel consumption unit.

Fuel consumption	Distance (driving range)
km/L	km
L/100 km	km
mpg	mile (s)

Changing the temperature unit*

E00523102301

The display unit for outside temperature can be switched.

1. When you lightly press the multi-information display switch a few times, the information display switches to the outside temperature display.

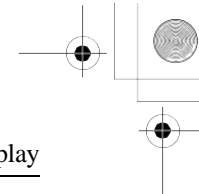
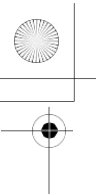

Multi-information display

Refer to “Information display” on page 5-4.

- Each time you press the multi-information display switch for about 5 seconds or more on outside temperature display, you can switch from °C to °F or from °F to °C unit of outside temperature display.

NOTE

- On vehicles with the automatic air conditioning, the temperature value on air conditioning panel is switched in conjunction with outside temperature display unit of the multi-information display.
However, “°C” or “°F” are not shown to temperature display of an air conditioning.



5

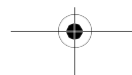
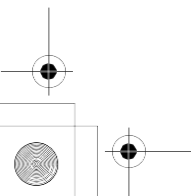

Instruments and controls 5-11

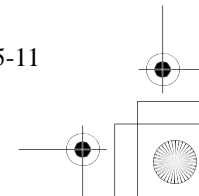

Indicator and warning lamps

Indicator and warning lamps

E00501504585

5

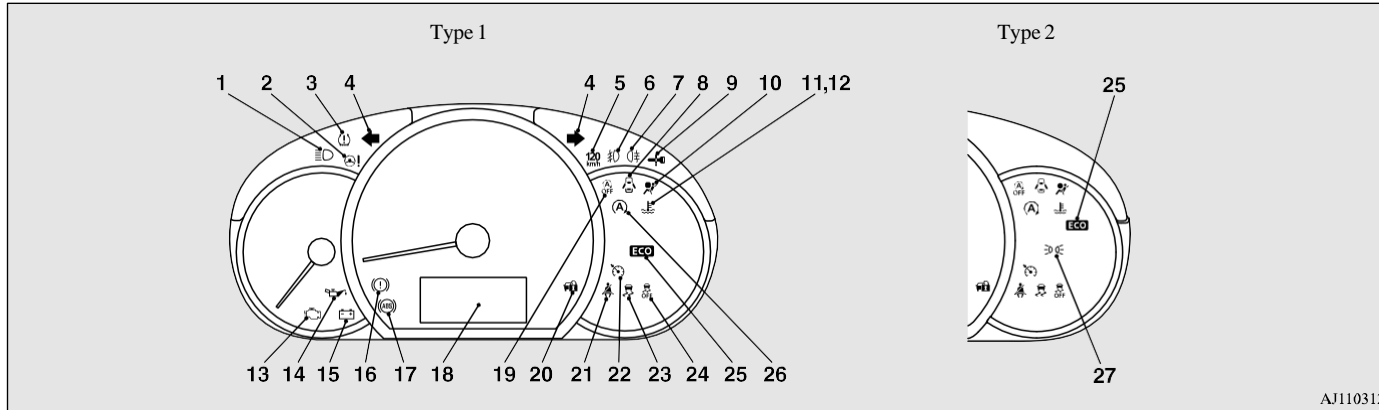

AJ1103121

- | | | |
|---|---|--|
| <p>1- High-beam indicator lamp → P.5-13</p> <p>2- Electric power steering system (EPS) warning lamp → P.6-37</p> <p>3- Tyre pressure monitoring system warning lamp* → P.6-45</p> <p>4- Turn-signal indicator lamps/Hazard warning indicator lamps → P.5-13</p> <p>5- Speed warning lamp* → P.5-17</p> <p>6- Front fog lamp indicator lamp* → P.5-13</p> <p>7- Rear fog lamp indicator lamp* → P.5-13</p> <p>8- Door-ajar warning lamp → P.5-17</p> | <p>9- For details, refer to “Warning activator” on page 3-12. (if so equipped)</p> <p>10- Supplemental restraint system (SRS) warning lamp → P.4-26</p> <p>11- High coolant temperature warning lamp (red) → P.5-16</p> <p>12- Low coolant temperature indicator lamp (green) → P.5-13</p> <p>13- Check engine warning lamp → P.5-15</p> <p>14- Oil pressure warning lamp → P.5-16</p> <p>15- Charge warning lamp → P.5-16</p> <p>16- Brake warning lamp → P.5-14</p> | <p>17- Anti-lock brake system (ABS) warning lamp* → P.6-36</p> <p>18- Multi-information display → P.5-2</p> <p>19- Auto Stop & Go (AS&G) OFF indicator lamp* → P.6-25</p> <p>20- For details, refer to “Warning activator” on page 3-12. (if so equipped)</p> <p>21- Seat belt warning lamp* → P.4-7</p> <p>22- Cruise control indicator lamp* → P.6-41</p> <p>23- Active Stability Control (ASC) indicator lamp* → P.6-39</p> |
|---|---|--|

5-12 Instruments and controls

- 24- Active Stability Control (ASC) OFF indicator lamp* → P.6-39
- 25- ECO indicator lamp* → P.5-14
- 26- Auto Stop & Go (AS&G) indicator lamp* → P.6-20
- 27- Position lamp indicator lamp* → P.5-13

Indicator lamps

E00501600139

Turn-signal indicator lamps/Hazard warning indicator lamps

E00501701515

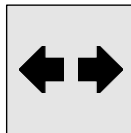

These indicator lamps blink in the following situations.

- When the turn-signal lever is moved to activate a turn-signal lamp. Refer to “Turn-signal lever” on page 5-22.

- When the hazard warning flasher switch is pressed to activate the hazard warning lamps. Refer to “Hazard warning flasher switch” on page 5-22.
- When the hazard warning lamps automatically activate due to sudden braking while driving. (Vehicles equipped with the emergency stop signal system) Refer to “Emergency stop signal system” on page 6-35.

High-beam indicator lamp

E00501800186

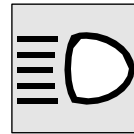

This indicator lamp illuminates when the high beam is used.

Front fog lamp indicator lamp*

E00501900480

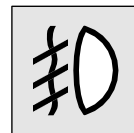

This indicator lamp illuminates while the front fog lamps are on.

Indicator lamps

Rear fog lamp indicator lamp*

E00502000231

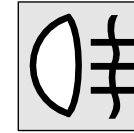

This indicator lamp illuminates while the rear fog lamp is on.

5

Position lamp indicator lamp*

E00508901268

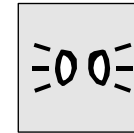

This indicator lamp illuminates while the position lamps are on.

Low coolant temperature indicator lamp

E00502200044



This indicator lamp illuminates in green when the coolant temperature is low.

Warning lamps

NOTE

- When the indicator lamp goes out, this should be used as a rough indication of when the heating starts working.

5

ECO indicator lamp*

E00529800117

ECO

This indicator lamp illuminates when fuel-efficient driving is achieved.

Warning lamps

E00502400176

Brake warning lamp

E00502502605



This lamp illuminates when the ignition switch is turned to the “ON” position or the operation mode is put in ON, and goes off after a few seconds.

Always make sure that the lamp goes off before driving. With the ignition switch or the operation mode in ON, the brake warning lamp illuminates under the following conditions:

- When the parking brake has been applied.
- When the brake fluid level in the reservoir falls to a low level.
- When the brake force distribution function is not operating correctly (vehicles with anti-lock brake system).

With the ignition switch or the operation mode in ON, a buzzer sounds under the following condition:

- The vehicle speed exceeds 8 km/h with the parking brake applied.

CAUTION

- In the situations listed below, brake performance may be compromised or the vehicle may become unstable if brakes are applied suddenly; consequently, avoid driving at high speeds or applying the brakes suddenly. Furthermore, immediately the vehicle should be brought to a stop in a safe location and your nearest authorised MITSUBISHI MOTORS dealer should be contacted.
- The brake warning lamp does not illuminate when the parking brake is applied or does not turn off when the parking brake is released.
- The ABS warning lamp and brake warning lamp illuminate at the same time. For details, refer to “ABS warning lamp” on page 6-36 (vehicles with anti-lock brake system).
- The brake warning lamp remains illuminated during driving.
- The vehicle should be brought to a halt in the following manner when brake performance has deteriorated.

Warning lamps

CAUTION

- Depress the brake pedal harder than usual. Even if the brake pedal moves down to the very end of its possible stroke, keep it pressed down hard.
- Should the brakes fail, use engine braking to reduce your speed and carefully pull the parking brake lever. Depress the brake pedal to operate the stop lamp to alert the vehicles behind you.

Check engine warning lamp

E00502603300

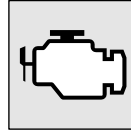

This lamp is a part of an onboard diagnostic system which monitors the emissions, engine control system or CVT control system.

If a problem is detected in one of these systems, this lamp illuminates or flashes. Although your vehicle will usually be drivable and not need towing, we recommend you to have the system checked immediately.

This lamp will also illuminate when the ignition switch is turned "ON" or the operation mode is put in ON, and goes off after the engine has started. If it does not go off after the engine has started, take the vehicle to an authorised MITSUBISHI MOTORS dealer.

CAUTION

- Prolonged driving with this lamp on may cause further damage to the emission control system. It could also affect fuel economy and drivability.
- If the lamp does not illuminate when the ignition switch is turned to the "ON" position or the operation mode is put in ON, have the system checked at an authorised MITSUBISHI MOTORS dealer.
- If the lamp illuminates while the engine is running, avoid driving at high speeds and have the system checked at an authorised MITSUBISHI MOTORS dealer immediately. Accelerator pedal and brake pedal response may be negatively influenced under these conditions.

5

NOTE

- The engine electronic control module accommodating the onboard diagnostic system has various fault data (especially about the exhaust emission) stored. This data will be erased if a battery cable is disconnected which will make a rapid diagnosis difficult. Do not disconnect a battery cable when the check engine warning lamp is ON.

Warning lamps

Charge warning lamp

E00502701235

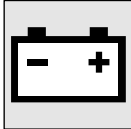

5

This lamp illuminates when the ignition switch is turned to the “ON” position or the operation mode is put in ON, and goes off after the engine has started.

CAUTION

- If it illuminates while the engine is running, there is a problem in the charging system. Immediately park your vehicle in a safe place and contact your nearest authorised MITSUBISHI MOTORS dealer.

Oil pressure warning lamp

E00502800691

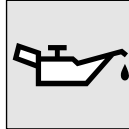

This lamp illuminates when the ignition switch is turned to the “ON” position or the operation mode is put in ON, and the lamp goes off after the engine has started. If it illuminates while the engine is running, the oil pressure is too low.

If the warning lamp illuminates while the engine is running, turn the engine off and contact your nearest authorised MITSUBISHI MOTORS dealer for inspection.

CAUTION

- If this lamp illuminates when the engine oil level is not low, contact your nearest authorised MITSUBISHI MOTORS dealer for inspection.
- This warning lamp does not indicate the amount of oil in the crankcase. This must be determined by checking the oil level on the dipstick, while the engine is switched off.
- If you continue driving with low engine oil level or with this warning lamp illuminated, engine seizure may occur.

NOTE

- The oil pressure warning lamp should not be treated as an indication of the engine’s oil level. The oil level must be checked using the dipstick.

High coolant temperature warning lamp

E00503000049

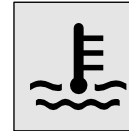

This lamp illuminates in red if the coolant temperature becomes excessively high.

CAUTION

- If the lamp illuminates during vehicle operation, it indicates that the engine is possibly overheating. Continued driving could make the engine fail. Immediately stop the vehicle in a safe place and take appropriate action. (Refer to “Engine overheating” on page 8-4.)

Combination headlamps and dipper switch

NOTE

- The high coolant temperature warning lamp may illuminate when the vehicle has been driven at high speeds or on hilly roads. This illuminating does not necessarily indicate a problem. It should stop if you keep the engine running for a while or continue driving the vehicle.

Door-ajar warning lamp

E00503301892



This lamp illuminates when a door is either open or not completely closed.

If the vehicle speed reaches approximately 8 km/h with a door open or incompletely closed, a buzzer sounds 4 times as a warning.

CAUTION

- Before moving your vehicle, check that the warning lamp is OFF.

Speed warning lamp*

E00531901053

120
km/h

If the vehicle speed exceeds about 120 km/h the lamp blinks.

Combination headlamps and dipper switch

E00506005452

Headlamps

NOTE

- When entering a country in which vehicles are driven on the opposite side of the road to the country in which your vehicle is supplied, necessary measures have to be taken to avoid dazzling oncoming traffic.
[For vehicles equipped with the LED headlamps]
Do not need any adjustment.
[For vehicles equipped with the Halogen headlamps]
Refer to “Masking the headlamps” on page 10-27.

NOTE

- Do not leave the lights on for a long time while the engine is stationary (not running). A run-down battery could result.
- When it rains, or when the vehicle has been washed, the inside of the lens sometimes becomes foggy, but this does not indicate a functional problem. When the lamp is switched on, the heat will remove the fog. However, if water gathers inside the lamp, please go to an authorised MITSUBISHI MOTORS dealer for a check.

Combination headlamps and dipper switch

Type 1

Rotate the switch to turn on the lamps.

5

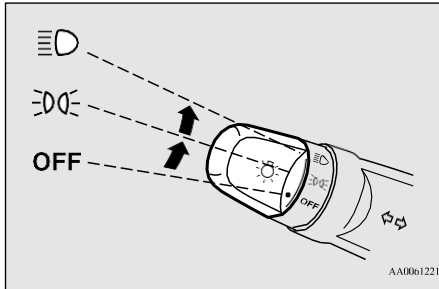

OFF	All lamps off {except for daytime running lamps (if so equipped)}
	Position, tail, licence plate and instrument panel lamps on
	Headlamps and other lamps go on

Type 2

Rotate the switch to turn on the lamps.

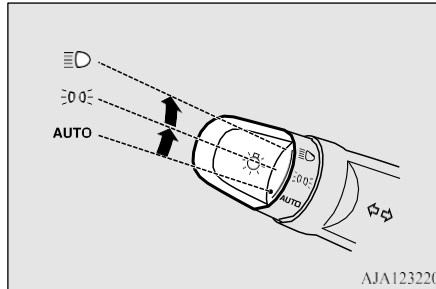

AUTO	With the ignition switch or the operation mode is in ON, headlamps, position, tail, licence plate, and instrument panel lamps turn on and off automatically in accordance with outside light level. {Daytime running lamps (if so equipped) will go on while the tail lamps are off.} All lamps turn off automatically when the ignition switch is turned to "OFF" position or the operation mode is put in OFF.
	Position, tail, licence plate and instrument panel lamps on
	Headlamps and other lamps go on

NOTE

- When the headlamps are turned off by the automatic on/off control with the ignition switch in the "ON" position or the operation mode in ON, the front fog lamps (if so equipped) and rear fog lamps (if so equipped) also go off. When the headlamps are subsequently turned back on by the automatic on/off control, the front fog lamps also come on but the rear fog lamp stay off. If you wish to turn the rear fog lamp back on, operate the switch again.
- Do not cover the sensor (A) for the automatic on/off control by affixing a sticker or label to the windscreen.

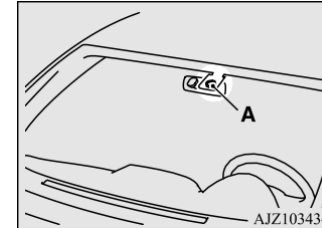

- If the lamps do not turn on or off with the switch in the "AUTO" position, manually operate the switch and have the vehicle inspected an authorised MITSUBISHI MOTORS dealer.

Lamps (headlamps, fog lamps, etc.) auto-cutout function

- If the following operation is performed while the lamp switch is in the “ ” position, the lamps will turn off automatically when the driver’s door is opened.

[Except for vehicles equipped with the keyless operation system]

The ignition switch is turned to the “LOCK” or “ACC” position, or the key is removed from the ignition switch.

[For vehicles equipped with the keyless operation system]

The operation mode is put in OFF or ACC.

- If the following operation is performed while the lamp switch is in the “ ” position, the lamps will remain on for about 3 minutes while the driver’s door is shut and will then automatically turn off.

[Except for vehicles equipped with the keyless operation system]

The ignition switch is turned to the “LOCK” or “ACC” position, or the key is removed from the ignition switch.



[For vehicles equipped with the keyless operation system]

The operation mode is put in OFF or ACC.

NOTE

- The lamp auto-cutout will not function when the lamp switch is in the “ ” position.
- The lamp auto-cutout function can also be disabled.
For further information, please contact your authorised MITSUBISHI MOTORS dealer.

When you want to keep the lamps on:

1. In the following cases, turn the lamp switch to the “OFF” or “AUTO” position.
[Except for vehicles equipped with the keyless operation system]
The ignition switch is in the “LOCK” or “ACC” position.
[For vehicles equipped with the keyless operation system]
The operation mode is in OFF or ACC.
2. Turn on the lamps with the switch in the “ ” or “ ” position again, then the lamps will remain on.

Lamp monitor buzzer

E00506101976

If the following operation is performed, a buzzer will sound to remind the driver to turn off the lamps.

Combination headlamps and dipper switch

[Except for vehicles equipped with the keyless operation system]

If the driver’s door is opened with the key removed from the ignition switch while the lamps are on.

[For vehicles equipped with the keyless operation system]

If the driver’s door is opened with the operation mode in OFF while the lamps are on.

5



In both cases, the buzzer will automatically stop if the auto-cutoff function is activated, the lamp switch is turned off, or the door is closed.

Daytime running lamps*

E00530601880

The daytime running lamps come on when the engine is running and the lamp switch is in the “OFF” or “AUTO” position and the tail lamps are off.

NOTE

- If the lamp switch is in the “ ” or “ ” position, or if the tail lamps are on when the lamp switch is in the “AUTO” position, the daytime running lamps come on as position lamps.

Combination headlamps and dipper switch

Dipper (High/Low beam change)

E00506201980

When the headlamps are on, the beam changes from high to low (or low to high) each time the lever is pulled fully (1). While the high beam is on, the high beam indicator lamp in the instrument cluster will also illuminate.

5

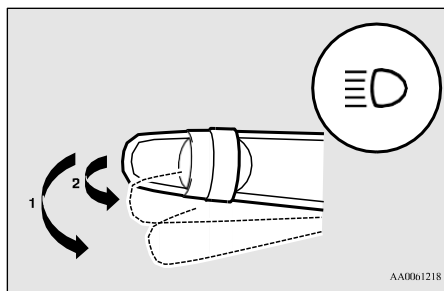

AA0061218

Headlamp flasher

E00506301604

The high beams flash when the lever is pulled slightly (2), and will go off when it is released.

When the high beam is on, the high beam indicator lamp in the instrument cluster will illuminate.

NOTE

- The high beams can also flash when the headlamps are off.
- If you turn the lamps off with the headlamps set to high beam, the headlamps are automatically returned to their low beam setting.

Welcome light*

E00528901903

This function turns on the position and tail lamps for about 30 seconds after the UNLOCK switch on the remote control transmitter is pressed when the combination headlamps and dipper switch is in the "OFF" position.

NOTE

- While the welcome light function is operating, perform one of the following operations to cancel the function.
 - Press the LOCK switch on the remote control transmitter.
 - Turn the combination headlamps and dipper switch to the "OFF" or "OFF" position.
 - Turn the ignition switch to the "ON" position or put the operation mode in ON.
- It is possible to modify functions as follows:
 - The headlamps can be set to come on in the low beam setting.

NOTE

- The welcome light function can be deactivated.
- For further information, please contact your authorised MITSUBISHI MOTORS dealer.

Coming home light*

E00529001695

This function turns on the headlamps in the low beam setting for about 30 seconds after the ignition switch is turned to the "LOCK" position or the operation mode is put in OFF.

1. Turn the combination headlamps and dipper switch to the "OFF" position.
2. Turn the ignition switch to the "LOCK" position or put the operation mode in OFF. Also, if a key was used to start the engine, remove the key from the ignition switch.
3. Within 60 seconds of turning the ignition switch to the "LOCK" position or putting the operation mode in OFF, pull the turn-signal lever towards you.

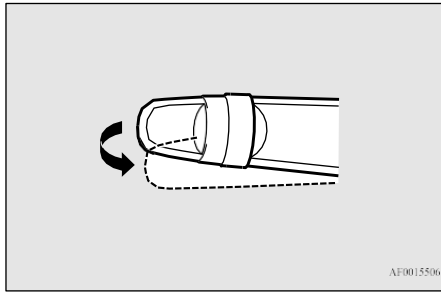

AF0015506

4. The headlamps will come on in the low beam setting for about 30 seconds. After the headlamps go off, the headlamps can be turned on again in the low beam setting for about 30 seconds by pulling the turn-signal lever towards you within 60 seconds of turning the ignition switch to the “LOCK” position or putting the operation mode in OFF.

To turn on the headlamps again after 60 seconds of turning the ignition switch to the “LOCK” position or putting the operation mode in OFF, repeat the process from step 1.

NOTE

- While the coming home light function is operating, perform one of the following operations to cancel the function.
 - Pull the turn-signal lever towards you.

NOTE

- Turn the combination headlamps and dipper switch to the “ ” or “ ” position.
- Turn the ignition switch to the “ON” position or put the operation mode in ON.
- It is possible to modify functions as follows:
 - The time that the headlamps remain on can be changed.
 - The coming home light function can be deactivated.

For further information, please contact your authorised MITSUBISHI MOTORS dealer.

Headlamp levelling switch*

E00506402181

The angle of the headlamp beam varies depending upon the load carried by the vehicle. The headlamp levelling switch can be used to adjust the headlamp illumination distance (when the lower beam is illuminated) so that the headlamps’ glare does not distract other drivers. Set the switch according to the following table.

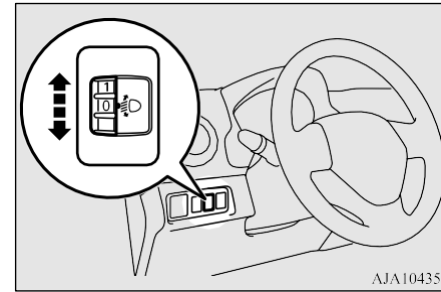

AJA104351

5

CAUTION

- Always perform adjustments before driving. Do not attempt to adjust while driving, as it could cause an accident.



NOTE

- When adjusting the beam position, first put the dial in the “0” position (the highest beam position).

Vehicle condition	Switch position
	“0”
	“1”

Turn-signal lever

5

Vehicle condition	Switch position
	"2"
	"3"
	"3"

● : 1 person

▨ : Full luggage loading

Switch position 0- Driver only

Switch position 1- Driver + 1 front passenger

Switch position 2- 5 passengers (including driver)

Switch position 3- 5 passengers (including driver) + Full luggage loading / Driver + Full luggage loading

Turn-signal lever

E00506501651

The turn-signal lamps flash when the lever is operated (with the ignition switch or the operation mode is in ON). At the same time, the turn-signal indicator flashes.

ation mode is in ON). At the same time, the turn-signal indicator flashes.

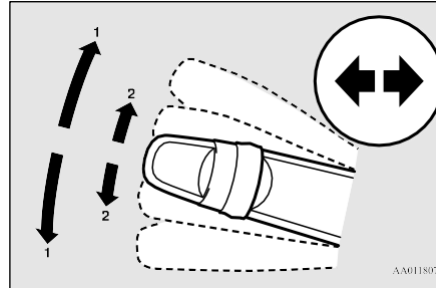

1- Turn-signals

When making a normal turn, use position (1). The lever will return automatically when cornering is completed.

2- Lane-change signals

When moving the lever to (2) slightly to change a lane, the turn-signal lamps and indicator lamp in the instrument cluster will only flash while the lever is operated.

Also, when you move the lever to (2) slightly then release it, the turn-signal lamps and indicator lamp in the instrument cluster will flash 3 times.

NOTE

- If the lamp flashes unusually quickly, the bulb in a turn-signal lamp may have burned out. Have the vehicle inspected by an authorised MITSUBISHI MOTORS dealer.
- It is possible to activate the following functions. For further information, please contact your authorised MITSUBISHI MOTORS dealer.
 - Flashing of the turn-signal lamps when the lever is operated with the ignition switch or the operation mode is in ACC.
 - The turn-signal lamps 3-flash function for lane changes can be deactivated.
 - The time required to operate the lever for the 3-flash function can be adjusted.
 - Changing of the tone of a sounding buzzer as the turn-signal lamps flash.

Hazard warning flasher switch

E00506602271

Use the hazard warning flasher switch when the vehicle has to be parked on the road for any emergency.

The hazard warning flashers can always be operated, regardless of the ignition switch position or the operation mode.

Fog lamp switch*

Push the switch to turn on the hazard warning flashers, all turn-signal lamps flash continuously.

To turn them off, push the switch again.

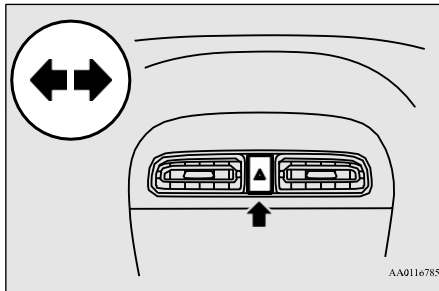

NOTE

- On vehicles equipped with the emergency stop signal system, while the hazard warning lamps are blinking due to having manually pushed the switch, the emergency stop signal system does not operate. Refer to “Emergency stop signal system” on page 6-35.

Fog lamp switch*

E00506700089

Front fog lamp switch*

E00508302041

The front fog lamps can be operated while the headlamps or tail lamps are on. Turn the knob in the “ON” direction to turn on the front fog lamps. An indicator lamp in the instrument cluster will also come on. Turn the knob in the “OFF” direction to turn off the front fog lamps. The knob will automatically return to its original position when you release it.

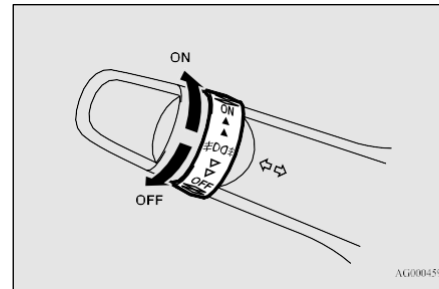

NOTE

- The front fog lamps are automatically turned off when the headlamps or tail lamps are turned off. To turn the front fog lamps on again, turn the knob in the “ON” direction after turning on the headlamps or tail lamps.
- Do not use fog lamps except in conditions of fog, otherwise excessive lamp glare may temporarily blind oncoming vehicle drivers.

5

Rear fog lamp switch*

E00508400615

The rear fog lamp can be operated when the headlamps or front fog lamps (if so equipped) turn on.

An indicator lamp in the instrument cluster comes on when the rear fog lamp is turned on.

[Vehicle without front fog lamps]

Turn the knob once in the “ON” direction to turn on the rear fog lamp. To turn the rear fog lamp off, turn the knob once in the “OFF” direction. The knob will automatically return to its original position when you release it.

[Vehicle with front fog lamps]

Turn the knob once in the “ON” direction to turn on the front fog lamps. Turn the knob

Wiper and washer switch

once more in the “ON” direction to turn on the rear fog lamp. To turn the rear fog lamp off, turn the knob once in the “OFF” direction. Turn the knob once more in the “OFF” direction to turn off the front fog lamps. The knob will automatically return to its original position when you release it.

5

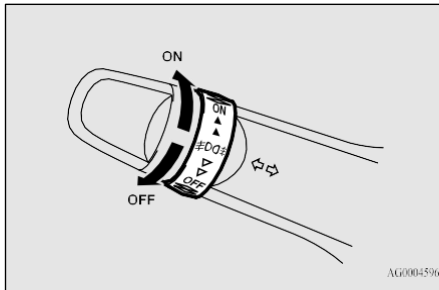

NOTE

- The rear fog lamp is automatically turned off when the headlamps or front fog lamps (if so equipped) are turned off.
- To turn the rear fog lamp on again, turn the knob once in the “ON” direction after turning on the headlamps. (Vehicle without front fog lamps)
- To turn the rear fog lamp on again, turn the knob twice in the “ON” direction after turning on the headlamps. (Vehicle with front fog lamps)

Wiper and washer switch

E00507102736

The windscreen wipers and washer can be operated with the ignition switch or the operation mode in ON or ACC.

If the blades are frozen to the windscreen, do not operate the wipers until the ice has melted and the blades are freed, otherwise the wiper motor may be damaged.

CAUTION

- If the washer is used in cold weather, the washer fluid sprayed against the glass may freeze, which may hinder visibility. Warm the glass with the defroster before using the washer.

Windscreen wipers

E00516902411

Except for vehicles equipped with rain sensor

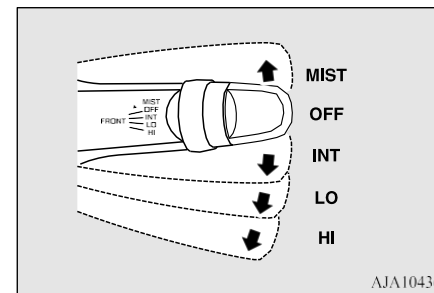

MIST- Misting function

The wipers will operate once.

OFF- Off

INT- Intermittent (Speed sensitive)

LO- Slow

HI- Fast

To adjust intermittent intervals

With the lever in the “INT” (speed sensitive intermittent operation) position, the intermittent intervals can be adjusted by turning the knob (A).

Wiper and washer switch

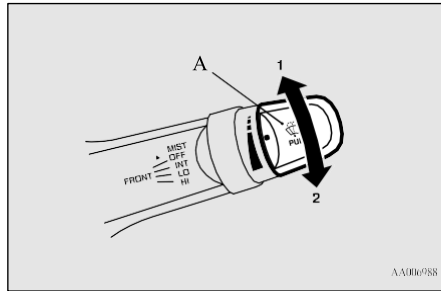

- 1- Fast
- 2- Slow

Misting function

Move the lever in the direction of the arrow and release, to operate the wipers once. Use this function when you are driving in mist or drizzle.

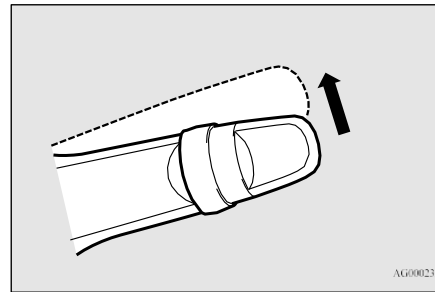

NOTE

- The speed-sensitive-operation function of the windscreen wipers can be deactivated. For further information, please contact your authorised MITSUBISHI MOTORS dealer.

Vehicles equipped with rain sensor

E00517001874

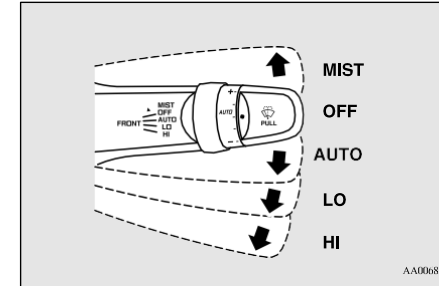

5

- MIST- Misting function
The wipers will operate once.
- OFF- Off
- AUTO- Auto-wiper control
Rain sensor
The wipers will automatically operate depending on the degree of wetness on the windscreen.
- LO- Slow
- HI- Fast

Rain sensor

Can only be used when the ignition switch or the operation mode is in ON.

If the lever is put in the "AUTO" position, the rain sensor (A) will detect the extent of rain (or snow, other moisture, dust, etc.) and the wipers will operate automatically.

Wiper and washer switch

Keep the lever in the “OFF” position if the windscreen is dirty and the weather is dry. Wiper operation under these conditions can scratch the windscreen and damage the wipers.

5

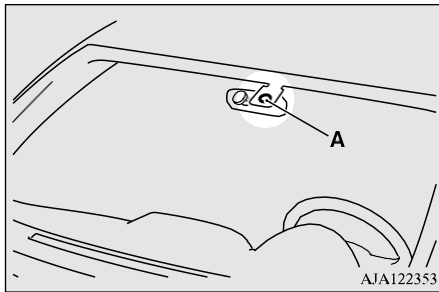

CAUTION

- With the ignition switch or the operation mode in ON and lever in the “AUTO” position, the wipers may automatically operate in the situations described below. If your hands get trapped, you could suffer injuries or the wipers could malfunction. Be sure to turn the ignition switch to the “LOCK” position or put the operation mode in OFF, or move lever to the “OFF” position to deactivate the rain sensor.
- When cleaning the outside surface of the windscreen, if you touch on top of the rain sensor.

CAUTION

- When cleaning the outside surface of the windscreen, if you wipe with a cloth on top of the rain sensor.
- When using an automatic car wash.
- A physical shock is applied to the windscreen.
- A physical shock is applied to the rain sensor.

NOTE

- To protect the rubber parts of the wipers, this operation of the wipers does not take place when the vehicle is stationary and the ambient temperature is about 0 °C or lower.
- Do not cover the sensor by affixing a sticker or label to the windscreen. Also, do not put any water-repellent coating on the windscreen. The rain sensor would not be able to detect the extent of rain, and the wipers might stop working normally.
- In the following cases, the rain sensor may be malfunctioning. Have the vehicle checked at an authorised MITSUBISHI MOTORS dealer.
 - When the wipers operate at a constant interval despite changes in the extent of rain.
 - When the wipers do not operate even though it is raining.

NOTE

- The wipers may automatically operate when things such as insects or foreign objects are affixed to the windscreen on top of the rain sensor or when the windscreen is frozen. Objects affixed to the windscreen will stop the wipers when the wipers cannot remove them. To operate the wipers again, move the lever in the “LO” or “HI” position. Also, the wipers may operate automatically due to strong direct sunlight or electromagnetic wave. To stop the wipers, place the lever in the “OFF” position.
- Contact an authorised MITSUBISHI MOTORS dealer when replacing the windscreen or reinforcing the glass around the sensor.

Wiper and washer switch

To adjust the sensitivity of the rain sensor

With the lever in the “AUTO” (rain sensor) position, it is possible to adjust the sensitivity of the rain sensor by turning the knob (B).

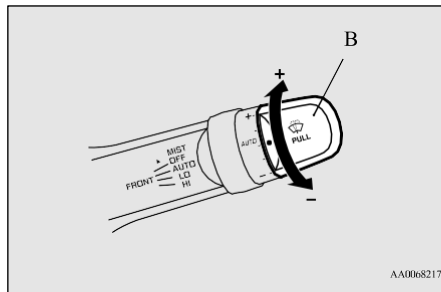

“+”- Higher sensitivity to rain
 “-”- Lower sensitivity to rain

Misting function

Move the lever in the direction of the arrow and release, to operate the wipers once. Use this function when you are driving in mist or drizzle.

The wipers will operate once if the lever is raised to the “MIST” position and released when the ignition switch or the operation mode is in ON or ACC. The wipers will continue to operate while the lever is held in the “MIST” position.

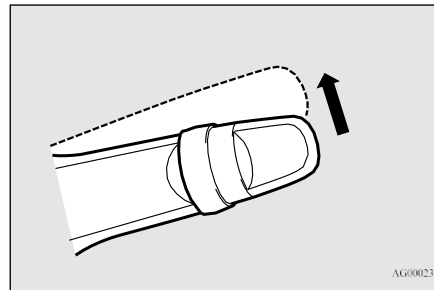

The wipers will operate once if the lever is moved to the “AUTO” position and the knob (C) is turned in the “+” direction when the ignition switch is in the “ON” position or the operation mode is in ON.

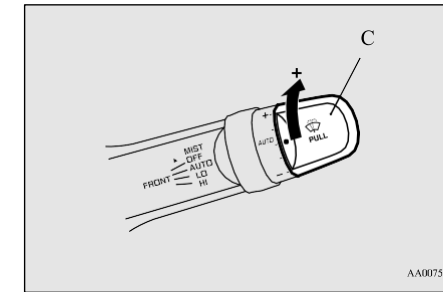

5

Windscreen washer

E00507202346

The washer fluid will be sprayed onto the windscreen by pulling the lever towards you. The wipers operate automatically several times while the washer fluid is being sprayed.

NOTE

- It is possible to activate the following functions:
 - Automatic operation (rain droplet sensitive) can be changed to intermittent operation (vehicle-speed sensitive).
 - Automatic operation (rain droplet sensitive) can be changed to intermittent operation (except vehicle-speed sensitive).

For further information, we recommend you to consult an authorised MITSUBISHI MOTORS dealer.

Rear window demister switch

5

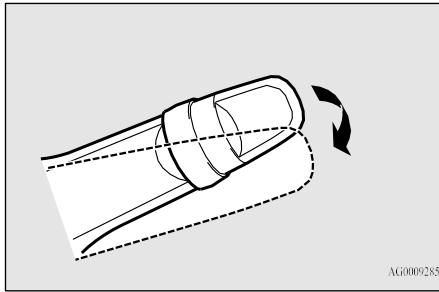

CAUTION

- If the washer is used in cold weather, the washer fluid sprayed against the glass may freeze resulting in poor visibility. Heat the glass with the defroster or demister before using the washer.

Precautions to observe when using wipers and washers

E00507601428

- If the moving wipers become blocked partway through a sweep by ice or other deposits on the glass, the wipers may temporarily stop operating to prevent the motor from overheating. In this case, park the vehicle in a safe place, turn the ignition switch to the “LOCK” position or put the operation mode in OFF, and then remove the ice or other deposits.

Rear window demister switch

E00507902561

The rear window demister switch can be operated when the engine is running.

Because the wipers will start operating again after the wiper motor cools down, check that the wipers operate before using them.

- Do not use the wipers when the glass is dry. They may scratch the glass surface and the blades wear out prematurely.
- Before using the wipers in cold weather, check that the wiper blades are not frozen onto the glass. The motor may burn out if the wipers are used with the blades frozen onto the glass.
- Avoid using the washer continuously for more than 20 seconds. Do not operate the washer when the fluid reservoir is empty. Otherwise, the motor may burn out.
- Periodically check the level of washer fluid in the reservoir and refill if required. During cold weather, add a recommended washer solution that will not freeze in the washer reservoir. Failure to do so could result in loss of washer function and frost damage to the system components.

Push the switch to turn on the rear window demister. It will be turned off automatically in about 20 minutes. To turn off the demister within about 20 minutes, push the switch again.

The indicator lamp (A) will illuminate while the demister is on.

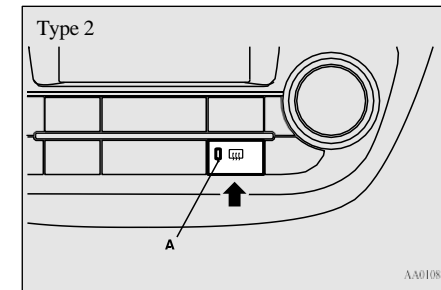
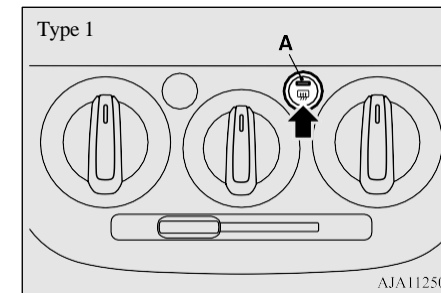

NOTE

- The demister switch is not to melt snow but to clear mist. Remove snow before use of the demister switch.
- To avoid unnecessary discharge of the battery, do not use the rear window demister during starting of the engine or when the engine is not running. Turn the demister off immediately after the window is clear.
- When cleaning the inside of the rear window, use a soft cloth and wipe gently along the heater wires, being careful not to damage the wires.
- Do not allow objects to touch the inside of the rear window glass, damaged or broken wires may result.

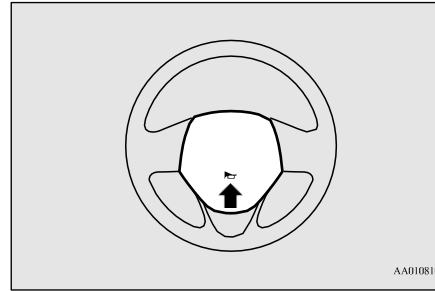

5

Horn switch

E00508000640

Press the steering wheel on or around the  mark.



Handwriting practice area consisting of ten horizontal dashed lines.

Starting and driving

Economical driving.....	6-2	Cargo loads.....	6-52
Driving, alcohol and drugs.....	6-3		
Safe driving techniques.....	6-3		
Running-in recommendations.....	6-3		
Parking brake.....	6-4		
Parking.....	6-5		
Steering wheel height adjustment.....	6-6		
Inside rear-view mirror.....	6-6		
Outside rear-view mirrors.....	6-7		
Ignition switch*.....	6-10		
Engine switch*.....	6-11		
Steering wheel lock.....	6-14		
Starting.....	6-15		
Auto Stop & Go (AS&G) system*.....	6-20		
Manual transmission*.....	6-25		
Automatic transmission INVECS-III CVT (Intelligent & Innovative Vehicle Electronic Control System III)*.....	6-26		
Braking.....	6-32		
Hill start assist*.....	6-33		
Brake assist system*.....	6-34		
Emergency stop signal system*.....	6-35		
Anti-lock brake system (ABS)*.....	6-35		
Electric power steering system (EPS).....	6-37		
Active stability control (ASC)*.....	6-38		
Cruise control*.....	6-40		
Tyre pressure monitoring system (TPMS)*.....	6-45		
Rear-view camera*.....	6-49		

Economical driving

Economical driving

E00600102507

For economical driving, there are some technical requirements that have to be met. The prerequisite for low fuel consumption is a properly adjusted engine. In order to achieve longer life of the vehicle and the most economical operation, have the vehicle serviced by an authorised MITSUBISHI MOTORS dealer at regular intervals in accordance with the service standards.

Fuel economy and generation of exhaust gas and noise are highly influenced by personal driving habits as well as the particular operating conditions. The following points should be observed in order to minimize wear of brakes, tyres and engine as well as to reduce environmental pollution.

Accelerating and decelerating

Drive according to traffic conditions, and avoid sudden starts, sudden acceleration, and sudden braking, as they will increase fuel consumption.

Shifting

Shift only at an appropriate speed and engine speed. Always use the highest shift position possible.

City traffic

Frequent starting and stopping increases the average fuel consumption. Use roads with smooth traffic flow whenever possible. When driving on congested roads, avoid use of a low shift position at high engine speeds.

Idling

The vehicle consumes fuel even during idling. Avoid extended idling whenever possible.

Speed

At higher the vehicle speed, more fuel is consumed. Avoid driving at full speed. Even a slight release of the accelerator pedal will save a significant amount of fuel.

Tyre inflation pressure

Check the tyre inflation pressures at regular intervals. Low tyre inflation pressure increases road resistance and fuel consumption. In addition, low tyre pressures adversely affect tyre wear and driving stability.

Load

Do not drive with unnecessary articles in the luggage compartment. Especially during city driving where frequent starting and stopping is necessary, the increased weight of the vehicle will greatly affect fuel consumption.

Cold engine starting

Starting of a cold engine consumes more fuel. Unnecessary fuel consumption is also caused by keeping a hot engine running. After the engine is started, commence driving as soon as possible.

Cooler or air conditioning

The use of the cooler or air conditioning will increase the fuel consumption.

6

Driving, alcohol and drugs

E00600201181

Drunk driving is one of the most frequent causes of accidents.

Your driving ability can be seriously impaired even with blood alcohol levels far below the legal minimum. If you have been drinking, do not drive. Ride with a designated non-drinking driver, call a cab or a friend, or use public transportation. Drinking coffee or taking a cold shower will not make you sober.

Similarly, prescription and nonprescription drugs affect your alertness, perception and reaction time. Consult with your doctor or pharmacist before driving while under the influence of any of these medications.

⚠ WARNING

- **NEVER DRINK AND DRIVE.**
Your perceptions are less accurate, your reflexes are slower and your judgment is impaired.

Safe driving techniques

E00600300619

Driving safety and protection against injury cannot be fully ensured. However, we recommend that you pay extra attention to the following:

Seat belts

Before starting the vehicle, make sure that you and your passengers have fastened your seat belts.

Floor mats

⚠ WARNING

- **Keep floor mats clear of the pedals by correctly laying floor mats that are suitable for the vehicle.**

To prevent the floor mats from slipping out position, securely retain them using the hook etc.

Note that laying a floor mat over a pedal or laying one floor mat on top of another can obstruct pedal operation and lead to a serious accident.



Carrying children in the vehicle

- Never leave your vehicle unattended with the key and children inside the vehicle. Children may play with the driving controls and this could lead to an accident.
- Make sure that infants and small children are properly restrained in accordance with the laws and regulations, and for maximum protection in case of an accident.
- Prevent children from playing in the luggage compartment. It is quite dangerous to allow them to play there while the vehicle is moving.

6

Loading luggage

When loading luggage, be careful not to load above the height of seats. This is dangerous not only because rearward vision will be obstructed, but also the luggage may be projected into the passenger compartment under hard braking.

Running-in recommendations

E00600404706

During the running-in period for the first 1,000 km, it is advisable to drive your new vehicle using the following precautions as a

Parking brake

guideline to aid long life as well as future economy and performance.

- Do not race the engine at high speeds.
- Avoid rapid starting, accelerating, braking and prolonged high-speed running.
- Keep to the running-in speed limit shown below.

Please note that the legal speed limits displayed must be adhered to.

- Do not exceed loading limits.
- Refrain from towing a trailer.

6

Vehicles with M/T

Shift point	Speed limit
1st gear	30 km/h
2nd gear	55 km/h
3rd gear	85 km/h
4th gear	110 km/h
5th gear	110 km/h

Vehicles with CVT

Shift point	Speed limit
“D” (DRIVE)	100 km/h

Parking brake

E00600501719

To park the vehicle, first bring it to a complete stop, fully apply the parking brake sufficiently to hold the vehicle.

To apply

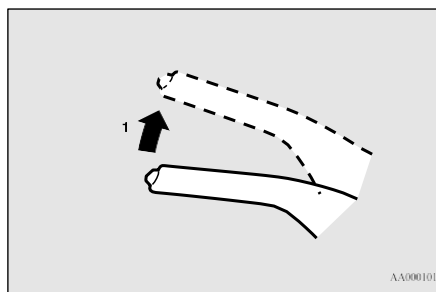

- 1- Firmly depress and hold the brake pedal, then pull the lever up without pushing the button at the end of hand grip.

CAUTION

- When you intend to apply the parking brake, firmly press the brake pedal to bring the vehicle to a complete stop before pulling the parking brake lever. Pulling the parking brake lever with the vehicle moving could make the rear wheels lock up, thereby making the vehicle unstable. It could also make the parking brake malfunction.

NOTE

- Apply sufficient force to the parking brake lever to hold the vehicle stationary after the foot brake is released.
- If the parking brake does not hold the vehicle stationary after the foot brake is released, contact your authorised MITSUBISHI MOTORS dealer.

Parking

To release

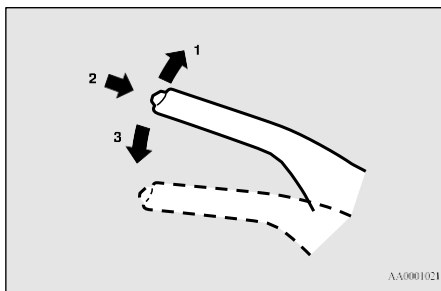

- 1- Firmly depress and hold the brake pedal, then pull the lever up slightly.
- 2- Push the button at the end of hand grip.
- 3- Lower the lever fully.

CAUTION

- Before driving, be sure that the parking brake is fully released and brake warning lamp is off. If you drive without the parking brake fully released, the warning lamp will illuminate and a buzzer sounds when the vehicle speed exceeds 8 km/h. If a vehicle is driven without releasing the parking brake, the brake will be overheated, resulting in ineffective braking and possible brake failure.

CAUTION

- If the brake warning lamp does not extinguish when the parking brake is fully released, the brake system may be abnormal. Contact your authorised MITSUBISHI MOTORS dealer. For details, refer to “Brake warning lamp” on page 5-14.

Parking

E00600602658

To park the vehicle, fully engage the parking brake, and then move the gearshift lever to 1st or “R” (Reverse) position for vehicles with M/T, or set the selector lever to “P” (PARK) position for vehicles with CVT.

Parking on a hill

To prevent the vehicle from rolling into the street, follow these procedures:

Parking on a downhill slope

Turn the front wheels toward the kerb and move the vehicle forward until the kerb side wheel gently touches the kerb.

Apply the parking brake and place the gearshift lever into the “R” (Reverse) position

(M/T) or the selector lever into the “P” (PARK) position (CVT).

If necessary, apply chocks to wheels.

Parking on an uphill slope

Turn the front wheels away from the kerb and move the vehicle back until the kerb side wheel gently touches the kerb.

Apply the parking brake and place the gearshift lever into the 1st position (M/T) or the selector lever into the “P” (PARK) position (CVT).

If necessary, apply chocks to wheels.

NOTE

- If your vehicle is equipped with CVT, be sure to apply the parking brake before moving the selector lever to the “P” (PARK) position. If you move the selector lever to the “P” (PARK) position before applying the parking brake, it may be difficult to disengage the selector lever from the “P” (PARK) position when next you drive the vehicle, requiring application of a strong force to the selector lever to move from the “P” (PARK) position.

6

Steering wheel height adjustment

Parking with the engine running

Never leave the engine running while you take a short sleep/rest. Also, never leave the engine running in a closed or poorly ventilated place.

6

⚠ WARNING

- Leaving the engine running risks injury or death from accidentally moving the gear-shift lever (M/T) or the selector lever (CVT) or the accumulation of toxic exhaust fumes on the passenger compartment.

Where you park

⚠ WARNING

- Do not park your vehicle in areas where combustible materials such as dry grass or leaves can come in contact with a hot exhaust, since a fire could occur.

Do not keep the steering wheel fully turned for a long time

More effort could be required to turn the steering wheel.
Refer to “Electric power steering system (EPS)” on page 6-37.

When leaving the vehicle

Always carry the key and lock all doors when leaving the vehicle unattended.
Always try to park your vehicle in a well lit area.

Steering wheel height adjustment

E00600700554

1. Release the lever while holding the steering wheel up.
2. Adjust the steering wheel to the desired position.
3. Securely lock the steering wheel by pulling the lever fully upward.

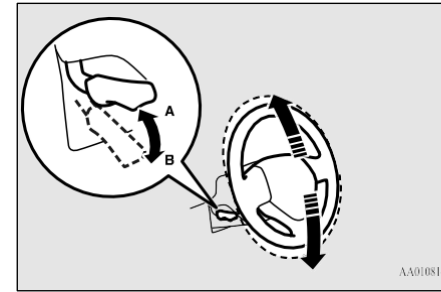

- A- Locked
B- Release

⚠ WARNING

- Do not attempt to adjust the steering wheel while you are driving the vehicle.

⚠ CAUTION

- When releasing the lever, hold the steering wheel by hand to prevent it falling to the lowest position.

Inside rear-view mirror

E00600800816

Adjust the rear-view mirror only after making any seat adjustments so you have a clear view to the rear of the vehicle.

Outside rear-view mirrors

⚠ WARNING

- Do not attempt to adjust the rear-view mirror while driving. This can be dangerous. Always adjust the mirror before driving.

Adjust the rear-view mirror to maximize the view through the rear window.

To adjust the vertical mirror position

It is possible to move the mirror up and down to adjust its position.

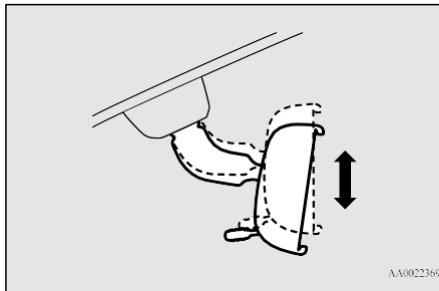

To adjust the mirror position

It is possible to move the mirror up/down and left/right to adjust its position.

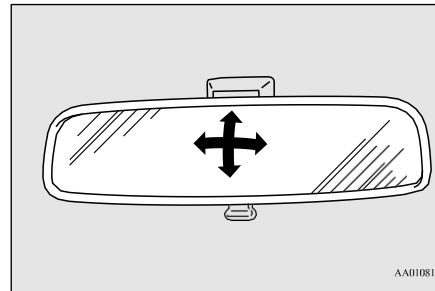

To reduce the glare

The lever (A) at the bottom of the mirror can be used to adjust the mirror to reduce the glare from the headlamps of vehicles behind you during night driving.

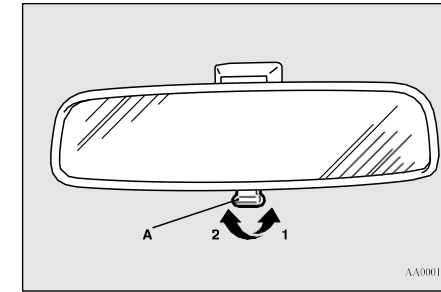

- 1- Normal
- 2- Anti-glare

Outside rear-view mirrors

E00600900761

⚠ WARNING

- Do not attempt to adjust the rear-view mirrors while driving. This can be dangerous. Always adjust the mirrors before driving.
- Your vehicle is equipped with convex type mirrors. Please take into consideration. Objects you see in the mirror will look smaller and farther away compared to a normal flat mirror. Do not use this mirror to estimate distance of following vehicles when changing lanes.

6

Outside rear-view mirrors

To adjust the mirror position

E00601001942

The outside rear-view mirrors can be adjusted when the ignition switch or the operation mode is in ON or ACC.

1. Place the lever (A) to the same side as the mirror whose adjustment is desired.

6

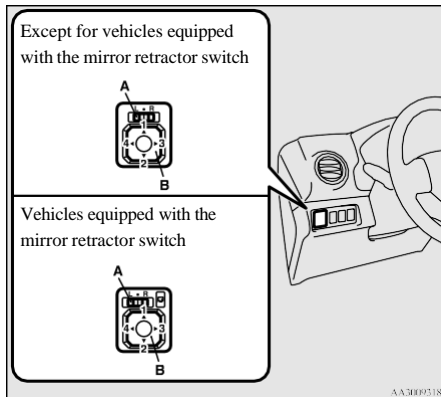

L- Left outside mirror adjustment
R- Right outside mirror adjustment

2. Press the switch (B) to the left, right, up or down to adjust the mirror position.

- 1-Up
- 2-Down
- 3-Right
- ◁ Left

6-8 Starting and driving

3. Return the lever (A) back to the middle position (•).

Retracting and extending the outside mirrors

E00618201698

The outside mirror can be folded in towards the side window to prevent damage when parking in narrow areas.

CAUTION

- Do not drive the vehicle with the mirror folded in. The lack of rearward visibility normally provided the mirror could lead to an accident.

[Except for vehicles equipped with the mirror retractor switch]

Push the mirror towards the back of the vehicle with your hand to retract it in. When extending the mirror, pull it out towards the front of the vehicle until it clicks to lock in place.

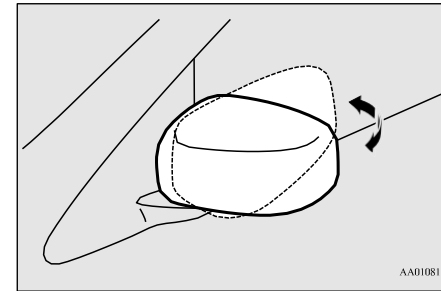

[For vehicles equipped with the mirror retractor switch]

Retracting and extending the mirrors using the mirror retractor switch

With the ignition switch or the operation mode in ON or ACC, push the mirror retractor switch to retract the mirrors.

Push it again to extend the mirrors to their original positions.

After turning the ignition switch to the "LOCK" position or putting the operation mode in OFF, it is possible to retract and extend the mirrors using the mirror retractor switch for about 30 seconds.

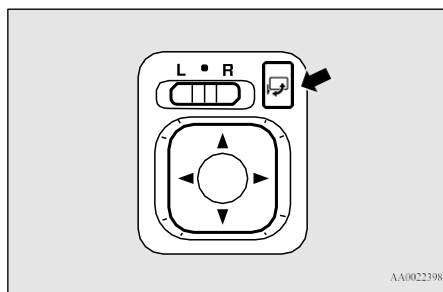

CAUTION

- It is possible to retract and extend the mirrors by hand. After retracting a mirror using the mirror retractor switch, however, you should extend it by using the switch again, not by hand. If you extended the mirror by hand after retracting it using the switch, it would not properly lock in position. As a result, the mirror could move because of the wind or vibration while you are driving, and this may prevent the driver's rearward visibility.

NOTE

- Be careful not to get your hands trapped while a mirror is moving.
- If you move a mirror by hand or it moves after hitting a person or object, you may not be able to return it to its original position using the mirror retractor switch. If this happens, push the mirror retractor switch to place the mirror in its retracted position and then push the switch again to return the mirror to its original position.
- When freezing has occurred and mirrors fail to operate as intended, please refrain from repeated pushing of the retractor switch as this action can result in burn-out of the mirror motor circuits.

Retracting and extending the mirrors without using the mirror retractor switch

[Except for vehicles equipped with keyless operation system]

The mirrors automatically retract or extend when the doors are locked or unlocked using the remote control switches of the keyless entry system.

Refer to "Keyless entry system" on page 3-4.

[Vehicles with the keyless operation system]

The mirrors automatically retract or extend when the doors are locked or unlocked using the remote control switches or the keyless operation function of the keyless operation system.

Refer to "Keyless entry system" on page 3-4.

Refer to "Keyless operation system: To operate using the keyless operation function" on pages 3-10.

NOTE

- Functions can be modified as stated below. Please consult an authorised MITSUBISHI MOTORS dealer.

Ignition switch*

6

NOTE

- Automatically extend when the driver's door is closed, and then the following operation is performed.
[Except for vehicles equipped with the keyless operation system]
Turn the ignition switch to the "ON" or "ACC" position.
[Vehicles equipped with the keyless operation system]
Put the operation mode in ON or ACC.
- Automatically retract when the ignition switch is turned to the "LOCK" position or the operation mode is put in OFF, and the driver's door is then opened.
- Automatically extend when the vehicle speed reaches 30 km/h.
- Deactivate the automatic extension function.
- The outside rear-view mirrors can be retracted or extended by the following operations, even if changing to the any of above.
After pressing the "LOCK" switch on the key to lock the doors, if the "LOCK" switch is pressed again twice in a row within about 30 seconds, the outside rear-view mirrors will retract.
After pressing the "UNLOCK" switch on the key to unlock the doors, if the "UNLOCK" switch is pressed again twice in a row within about 30 seconds, the outside rear-view mirrors will extend again.

Ignition switch*

E00601402190

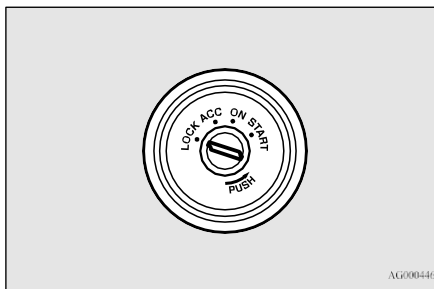

AG0004466

LOCK

The engine is stopped and the steering wheel locked. The key can be inserted and removed in this position.

ACC

The engine is stopped, but the audio system and other electric devices can be operated.

ON

All the vehicle's electrical devices can be operated.

START

The starter motor operates. After the engine has started, release the key and it will automatically return to the "ON" position.

NOTE

- If your vehicle is equipped with an electronic immobilizer. To start the engine, the ID code which the transponder inside the key sends must match the one registered to the immobilizer computer.
(Refer to "Electronic immobilizer (Anti-theft starting system)" on page 3-3.)

To remove the key

E00620400498

For vehicles equipped with a M/T, when removing the key, push the key in at the "ACC" position and keep it depressed until it is turned to the "LOCK" position and remove it.

For vehicles equipped with CVT when removing the key, first set the selector lever to the "P" (PARK) position, and push the key in at the "ACC" position and keep it depressed until it is turned to the "LOCK" position, and remove it.

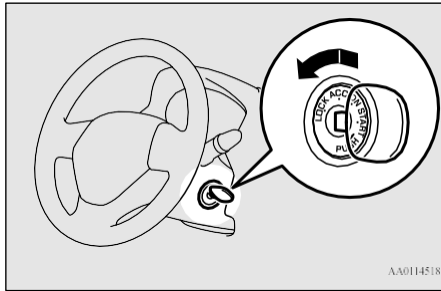

AA0114518

Ignition key reminder*

E00654100043

If the ignition switch is turned off and the driver's door is opened with the key in the ignition switch, the key reminder buzzer will sound intermittently to remind you to remove the key.

CAUTION

- Do not remove the ignition key from the ignition switch while driving. The steering wheel will be locked, causing loss of control.
- If the engine is stopped while driving, the brake servomechanism will cease to function and braking efficiency will deteriorate. Also, the power steering system will not function and it will require greater manual effort to operate the steering.
- Do not leave the key in the "ON" position for a long time when the engine is not running, doing so will cause the battery to be discharged.
- Do not turn the key to the "START" position when the engine is running, doing so could damage the starter motor.

Engine switch*

Engine switch*

E00631801620

In order to prevent theft, the engine will not start unless a preregistered keyless operation key is used. (Engine immobilizer function)
If you are carrying the keyless operation key, you can start the engine.

If you have to start the engine in emergency by using spare key, insert the spare key into the key slot.

6

Refer to "If the keyless operation key is not operation properly or if the engine starts by using spare key" on page 6-19.

Also refer to "Starting" on page 6-15.

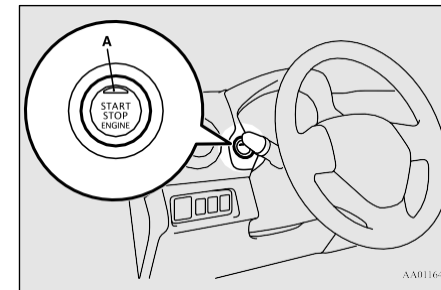

AA0116479

Engine switch*

6

CAUTION

- The indicator lamp (A) will flash orange when there is a problem or malfunction in the keyless operation system. Never drive if the indicator lamp on the engine switch is flashing orange. Immediately contact your authorised MITSUBISHI MOTORS dealer.
- If the engine switch operation is not smooth and feels like it is sticking, do not operate the switch. Immediately contact your authorised MITSUBISHI MOTORS dealer.

NOTE

- When operating the engine switch, press the switch all the way in. If the switch is not fully pressed, the engine may not start or the operation mode may not change. If the engine switch is pressed correctly, there is no need to hold the engine switch down.
- When the battery in the keyless operation key has worn out, or the keyless operation key is out of the vehicle, a warning lamp will blink for 5 seconds.

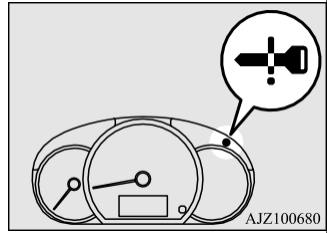

Operation mode of the engine switch and its function

OFF

The indicator lamp on the engine switch goes off.

The operation mode cannot be put in OFF when the selector lever is in any position other than the “P” (PARK) position (CVT).

ACC

Electrical devices such as the audio and accessory socket can be operated. The indicator lamp on the engine switch illuminates orange.

ON

All vehicle’s electrical devices can be operated. The indicator lamp on the engine switch illuminates green. The indicator lamp goes off when the engine is running.

NOTE

- Your vehicle is equipped with an electronic immobilizer. To start the engine, the ID code which the transponder inside the key sends must match the one registered in the immobilizer computer. Refer to “Electronic immobilizer (Anti-theft starting system)” on page 3-3.

Changing the operation mode

E00631901562

If you press the engine switch without depressing the brake pedal (CVT) or the clutch pedal (M/T), you can change the operation mode in the order of OFF, ACC, ON, OFF.

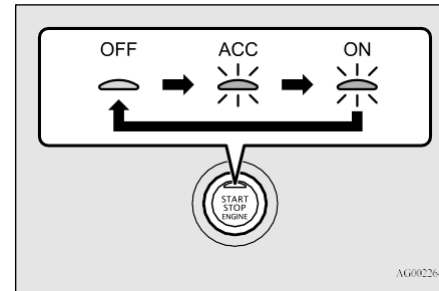

Engine switch*

CAUTION

- When the engine is not running, put the operation mode in OFF. Leaving the operation mode in ON or ACC for a long time when the engine is not running may cause the battery to be discharged, making it impossible to start the engine, lock and unlock the steering wheel.
- When the battery is disconnected, the current operation mode is memorized. After reconnecting the battery, the memorized mode is selected automatically. Before disconnecting the battery for repair or replacement, make sure to put the operation mode in OFF. Be careful if you are not sure which operation mode the vehicle is in when the battery is run down.
- The operation mode cannot be changed from OFF to ACC or ON if the keyless operation key is not detected to be in the vehicle. Refer to “Keyless operation system: Operating range for starting the engine and changing the operation mode” on page 3-9.
- When there is the keyless operation key in the vehicle and the operation mode isn't changed, the keyless operation key may have worn out.

NOTE

- If the operation mode cannot be changed to OFF, perform the following procedure.

NOTE

1. Move the selector lever to the “P” (PARK) position, and then change the operation mode to OFF. (For vehicles with CVT)
2. One of the other causes could be low battery voltage. If this occurs, the keyless entry system, keyless operation function, and steering lock will also not operate. Contact an authorised MITSUBISHI MOTORS dealer.

ACC power auto-cutout function

E00632801728

After approximately 30 minutes has elapsed with the operation mode in ACC, the function automatically cuts out the power for the audio system and other electric devices that can be operated with that position. When you open driver's door or the engine switch operate again, the power is supplied again.

NOTE

- When ACC power supply automatically stops, the steering wheel can't lock and you can't lock and unlock the doors by the keyless entry system.
- It is possible to modify functions as follows:

NOTE

- The time until the power cuts out can be changed to approximately 60 minutes.
- The ACC power auto-cutout function can be deactivated. For details, please consult an authorised MITSUBISHI MOTORS dealer.

Operation mode OFF reminder system

E00632201504

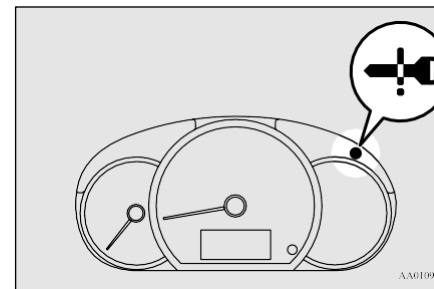

When the operation mode is in any mode other than OFF, if you try to lock the doors by pressing the driver's door lock/unlock switch, a warning lamp will blink and the outer buzzer will sounds for approximately 3 seconds and you cannot lock the doors.

Steering wheel lock

Operation mode ON reminder system

E0063230016

If the driver's door is opened with the engine stopped and the operation mode in any mode other than OFF, the operation mode ON reminder inner buzzer sounds intermittently to remind you to put the operation mode in OFF.

6

Steering wheel lock

E00601502465

[Except for vehicles equipped with the keyless operation system]

To lock

Remove the key at the "LOCK" position. Turn the steering wheel until it is locked.

To unlock

Turn the key to the "ACC" position while moving the steering wheel slightly right and left.

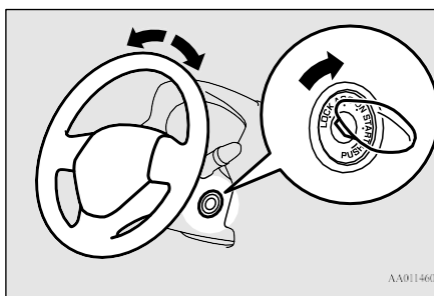

AA0114606

CAUTION

- Remove the key when leaving the vehicle. In some countries, it is prohibited to leave the key on the vehicle when parked.

[For vehicles equipped with the keyless operation system]

To lock

After pressing the engine switch and putting the operation mode in OFF, when driver's door is opened, the steering wheel is locked.

NOTE

- When the following operation is performed with the operation mode in OFF and the selector lever is in the "P" (PARK) position, the steering wheel is locked.
 - Open or close the driver's door.
 - Close all the doors and the tailgate.
 - Open one of the doors or the tailgate when all the doors and the tailgate are closed.
 - Press the LOCK switch on the keyless operation key, the driver's door switch.
- When the doors or the tailgate are opened while the steering wheel does not lock, the buzzer sounds to alert the steering wheel is unlocked.

To unlock

The following methods can be used to unlock the steering wheel.

- Put the operation mode in ACC.
- Start the engine.

CAUTION

- If the engine is stopped while driving, do not open a door or press the LOCK switch on the remote control switch until the vehicle stops in a safe place. This could cause the steering wheel to lock, making it impossible to operate the vehicle.

CAUTION

- Carry the key with you when leaving the vehicle.
If your vehicle needs to be towed, unlock the steering wheel.
Refer to “Towing: Emergency towing” on page 8-13.

NOTE

- When the steering wheel does not unlock, the warning lamp will blink and the inner buzzer will sound. Press the engine switch again while moving the steering wheel slightly right and left.
- When the steering wheel lock is abnormal, the warning lamp illuminates. Put the operation mode in OFF and then press the lock switch of the keyless operation key. And then press the engine switch, If the warning lamp illuminates again, contact an authorised MITSUBISHI MOTORS dealer.

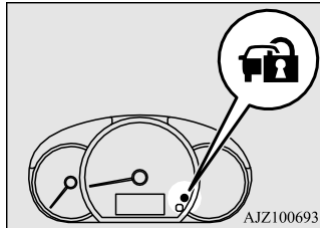

NOTE

- If there is a fault in the steering wheel lock, the warning lamp illuminates and the inner buzzer sounds. Immediately stop the vehicle in a safe place and contact your nearest authorised MITSUBISHI MOTORS dealer.

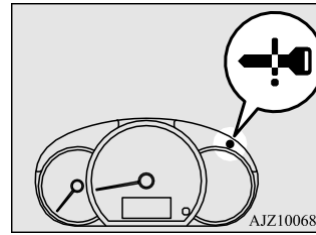

Starting

E00601601052

Tips for starting

E00632401043

[Except for vehicles equipped with the keyless operation system]

Do not operate the starter motor continuously longer than 10 seconds; doing so could run down the battery. If the engine does not start, turn the ignition switch back to “LOCK”, wait a few seconds, and then try again.

Trying repeatedly with the starter motor still turning will damage the starter mechanism.

WARNING

- **Never run the engine in a closed or poorly ventilated area any longer than is needed to move your vehicle in or out of the area. Carbon monoxide gases are odourless and can be fatal.**

CAUTION

- Never attempt to start the engine by pushing or pulling the vehicle.
- Do not run the engine at high revolutions or drive the vehicle at high speed until the engine has had a chance to warm up.
- Release the ignition key as soon as the engine starts to avoid damaging the starter motor.

6

[For vehicles equipped with the keyless operation system]

- The operation mode can be in any mode to start the engine.
- The starter motor will be turning for up to approximately 15 seconds if the engine switch is released at once. Pressing the engine switch again while the starter motor is still turning will stop the starter motor. The starter motor will be turning for up to approximately 30 seconds while the engine switch is pressed.

Starting

If the engine does not start, wait for a while and then attempt to start the engine again. Trying repeatedly with the starter motor still turning will damage the starter mechanism.

WARNING

- Never run the engine in a closed or poorly ventilated area any longer than is needed to move your vehicle in or out of the area. Carbon monoxide gases are odourless and can be fatal.

6

CAUTION

- Never attempt to start the engine by pushing or pulling the vehicle.
- Do not run the engine at high revolutions or drive the vehicle at high speed until the engine has had a chance to warm up.

Starting the engine

E00601703712

[Except for vehicles equipped with the keyless operation system]

The starting procedure is as follows:

1. Insert the ignition key and fasten the seat belt.
2. Make sure the parking brake is applied.
3. Depress and hold the brake pedal.

6-16 Starting and driving

4. Fully depress the clutch pedal (M/T).

NOTE

- On vehicles equipped with M/T, the starter will not operate unless the clutch pedal is fully depressed (Clutch interlock).

5. On vehicles with M/T, place the gearshift lever in the “N” (Neutral) position. On vehicles with CVT, make sure the selector lever is in the “P” (PARK) position.

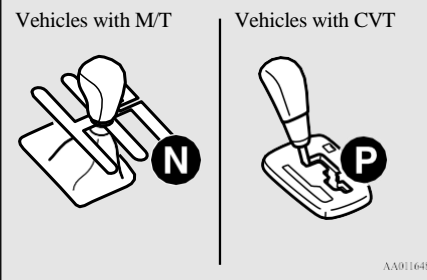

6. After turning the ignition key to the “ON” position, make certain that all warning lamps are functioning properly before starting the engine.
7. Turn the ignition key to the “START” position and release it when the engine starts.

NOTE

- Minor noises may be heard on engine start-up. These will disappear as the engine warms up.

When the engine is hard to start

After several attempts, you may experience that the engine still does not start.

1. Make sure that all electric devices, such as lamps, air conditioning blower and rear window demister, are turned off.
2. While depressing the brake pedal on vehicles equipped with CVT or the clutch pedal on the vehicles equipped with manual transmission, press the accelerator pedal halfway and hold it there, then crank the engine. Release the accelerator pedal, immediately after the engine starts.

Starting

3. If the engine still will not start, the engine could be flooded with too much petrol. While depressing the brake pedal on vehicles equipped with CVT or the clutch pedal on the vehicles equipped with manual transmission, push the accelerator pedal all the way down and hold it there, then crank the engine for 5 to 6 seconds. Return the ignition switch to the "LOCK" position and release the accelerator pedal. Wait a few seconds, and then crank the engine again for 5 to 6 seconds while depressing the brake pedal or the clutch pedal, but do not push the accelerator pedal. Release the ignition switch if the engine starts. If the engine fails to start, repeat these procedures. If the engine still will not start, contact your authorised MITSUBISHI MOTORS dealer.

[For vehicles equipped with the keyless operation system]

The starting procedure is as follows:

1. Fasten the seat belt.
2. Make sure the parking brake is applied.
3. Press and hold the brake pedal down firmly with your right foot.

NOTE

- After the engine has not started for a while, the brake pedal effort needed to start the engine may become greater. If this occurs, depress the brake pedal more firmly than usual.

4. Fully depress and hold the clutch pedal (M/T).

NOTE

- On vehicles equipped with M/T, the starter will not operate unless the clutch pedal is fully depressed (Clutch interlock).

5. On vehicles with M/T, place the gearshift lever in the "N" (Neutral) position. On vehicles with CVT, make sure the selector lever is in the "P" (PARK) position.

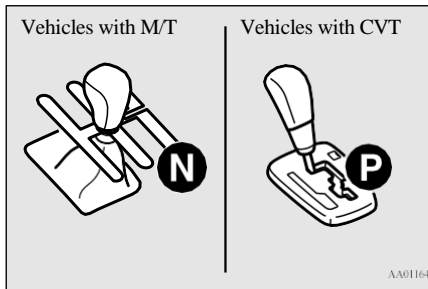

6. Press the engine switch.

7. Make certain that all warning lamps are functioning properly.

NOTE

- Minor noises may be heard on engine start-up. These will disappear as the engine warms up.

When the engine is hard to start

6

After several attempts, you may experience that the engine still does not start.

1. Make sure that all electric devices, such as lamps, air conditioning blower and rear window demister, are turned off.
2. While depressing the brake pedal on vehicles equipped with CVT or the clutch pedal on the vehicles equipped with manual transmission, press the accelerator pedal halfway and hold it there, then crank the engine. Release the accelerator pedal, immediately after the engine starts.

Starting

6

3. If the engine still will not start, the engine could be flooded with too much petrol. While depressing the brake pedal on vehicles equipped with CVT or the clutch pedal on the vehicles equipped with manual transmission, push the accelerator pedal all the way down and hold it there, then press the engine switch to crank the engine. If the engine does not start after 5 to 6 seconds, push the engine switch to stop cranking the engine, and release the accelerator pedal. Put the operation mode in OFF. Wait a few seconds, and then press the engine switch to crank the engine again while depressing the brake pedal or the clutch pedal, but do not push the accelerator pedal. If the engine fails to start, repeat these procedures. If the engine still will not start, contact your authorised MITSUBISHI MOTORS dealer.

Stopping the engine

E00632701075

[Except for vehicles equipped with the keyless operation system]

1. Bring the vehicle to a complete stop.
2. Firmly apply the parking brake while depressing the brake pedal.
3. For vehicles equipped with M/T, turn the ignition switch to the "LOCK" position to stop the engine, and then move the gear-shift lever to the 1st (on an uphill) or "R" (Reverse) (on a downhill) position. For vehicles equipped with CVT, place the selector lever in the "P" (PARK) position, and stop the engine.

[For vehicles equipped with the keyless operation system]

WARNING

- Do not operate the engine switch while driving except in an emergency. If the engine is stopped while driving, the brake servomechanism will cease to function and braking efficiency will deteriorate. Also, the power steering system will not function and it will require greater manual effort to operate the steering. This could result in a serious accident.

NOTE

- If you have to bring the engine to an emergency stop while driving, press and hold the engine switch for 3 seconds or more, or press it quickly 3 times or more. The engine will stop and the operation mode will go to ACC.
- Do not stop the engine with the selector lever in any position other than the "P" (PARK) position (CVT). If the engine is stopped with the selector lever in any position other than the "P" (PARK) position, the operation mode will go to ACC rather than OFF. Put the operation mode in OFF after placing the selector lever in the "P" (PARK) position.
- On vehicles with CVT, while the engine is stopped automatically by Auto Stop & Go (AS&G) system, if the selector lever is moved to the "P" (PARK) position quickly with the brake pedal firmly depressed, the engine does not restart automatically even if you release the brake pedal. If this occurs, the indicator will blink to inform the driver. If you want to put the operation mode in OFF, press the engine switch without depressing the brake pedal.

1. Stop the vehicle.
2. Fully engage the parking brake while depressing the brake pedal.

3. On vehicles with M/T, press the engine switch to stop the engine, move the gear-shift lever to the 1st (on a uphill) or “R” (Reverse) (on a downhill) position.

On vehicles with CVT, move the selector lever to the “P” (PARK) position, press the engine switch to stop the engine.

If the keyless operation key is not operating properly or if the engine starts by using spare key

E00632501145

Insert the keyless operation key or spare key into the key slot. Starting the engine and changing the operation mode should be now possible.

Remove the keyless operation key or spare key from the key slot after starting the engine or changing the operation mode.

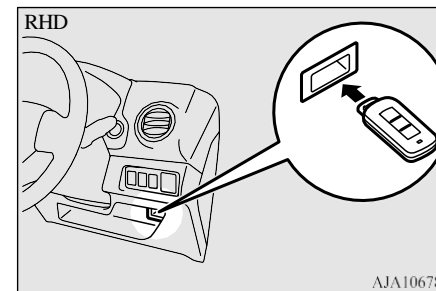

6

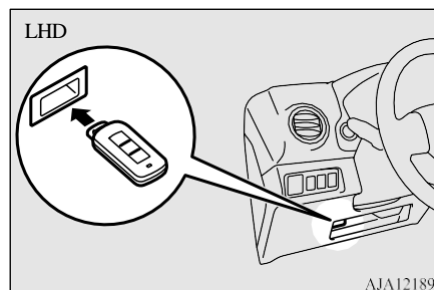

NOTE

- Do not insert into the key slot anything other than the keyless operation key or spare key. This could cause damage or a malfunction.
- Remove the object or additional key from the keyless operation key or spare key before inserting the key into the key slot. The vehicle may not be able to receive the registered ID code from the registered key. Therefore, the engine may not start and the operation mode may not change.
- The keyless operation key is fixed in the key slot when inserted in the illustrated direction. Simply pull out the key to remove it from the key slot.

Auto Stop & Go (AS&G) system*

Keyless operation key reminder*

E00632600022

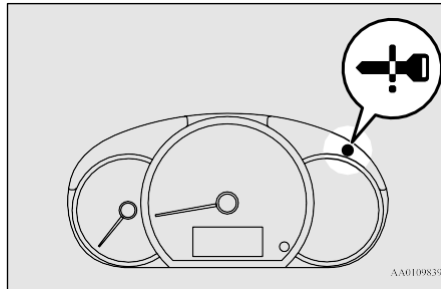

6

If the operation mode is in OFF and the driver's door is opened with the keyless operation key in the key slot, the warning lamp will blink and the outer buzzer sounds for approximately 3 seconds and the inner buzzer sounds for approximately 1 minute to remind you to remove the key.

Auto Stop & Go (AS&G) system*

E00627401218

The Auto Stop & Go (AS&G) system automatically stops and restarts the engine without operating the ignition switch or engine switch when the vehicle is stopped, such as at

6-20 Starting and driving

a traffic light or in a traffic jam, to reduce exhaust gases, increase fuel efficiency.

CAUTION

- If the vehicle will be stopped for a long time or if you will leave the vehicle unattended, stop the engine.

NOTE

- The accumulated time the engine has been stopped by Auto Stop & Go (AS&G) system is displayed in the multi information display. Refer to "Auto Stop & Go (AS&G) monitor" on page 5-6.
- If the Auto Stop & Go (AS&G) system does not operate or it operates less frequently, the battery capacity may have decreased. Have your vehicle inspected by an authorised MITSUBISHI MOTORS dealer.

Automatically stopping the engine

E00627501583

The Auto Stop & Go (AS&G) system is automatically activated when the ignition switch is turned to the "ON" position or the operation mode is put in ON.

You can deactivate the system by pressing the "Auto Stop & Go (AS&G) OFF" switch.

Refer to "To deactivate" on page 6-25.

When the Auto Stop & Go (AS&G) system will operate, the (A) indicator lamp will turn on to inform the driver.

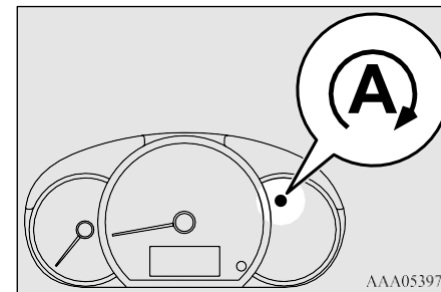

[For vehicles with M/T]

1. Stop the vehicle.

Auto Stop & Go (AS&G) system*

2. While depressing the brake pedal, fully depress the clutch pedal and place the gearshift lever in the “N” (Neutral) position.

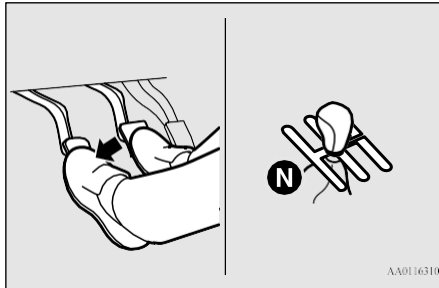

AA0116310

3. Release the clutch pedal. The engine will stop automatically.

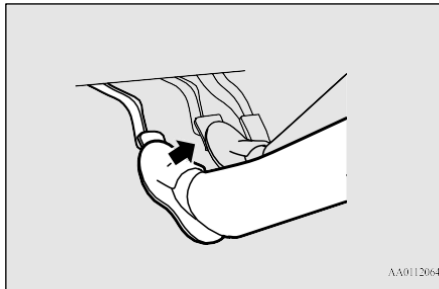

AA0112064

[For vehicles with CVT]

1. Stop the vehicle.

2. Depressing the brake pedal. The engine will stop automatically.

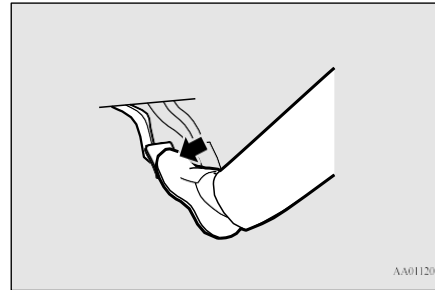

AA0112080

NOTE

- When the engine is automatically stopped, changes will occur in the driving operations. Pay careful attention to the following.
 - The brake booster becomes inoperative and the pedal effort will increase. If the vehicle is moving, press down the brake pedal harder than usual.
 - The electric power steering system (EPS) becomes inoperative and it will become harder to turn the steering wheel.



CAUTION

- When the engine is automatically stopped, do not attempt to exit the vehicle. Because the engine restarts automatically when the driver’s seat belt is unfastened or the driver’s door is opened, an unexpected accident might occur when the vehicle starts moving.
- Observe the following precautions when the engine is stopped automatically. Otherwise, an unexpected accident might occur when the engine restarts automatically.
 - Do not depress the accelerator pedal to race the engine while the vehicle is stopped (regardless of whether the engine is running or stopped).
 - On vehicles with M/T, do not move the gearshift lever to a position other than the “N” (Neutral) position. If the gearshift lever is moved to a position other than the “N” (Neutral) position, the (A) indicator lamp blinks and the buzzer sounds. If the gearshift lever is returned to the “N” (Neutral) position, the (A) indicator lamp stops blinking and the buzzer stops sounding. The engine will not restart if the gearshift lever is in a position other than the “N” (Neutral) position.



Auto Stop & Go (AS&G) system*

6

NOTE

- In the following cases, the  indicator lamp will blink to inform the driver and the engine will not stop automatically.
 - Driver's seat belt is not fastened
 - Driver's door is open
 - Bonnet is open
- In the following cases, the  indicator lamp will turn off and the engine will not stop automatically even if the vehicle is stopped.
 - After the engine starts, the vehicle speed has not exceeded approximately 5 km/h
 - After the engine start, approximately 30 seconds or more have not elapsed
 - After the engine restarts automatically, the vehicle stops again within 10 seconds
 - Engine coolant temperature is low
 - Ambient temperature is low
 - When using the heater, vehicle interior temperature is not warm enough
 - Air conditioner is operating and passenger compartment has not sufficiently cooled
 - When using the air conditioner at the demister position
 - When the air conditioner is operated in AUTO mode where the temperature control is set to the max. hot or the max. cool (for vehicles with automatic air conditioning)
 - Electric power consumption is high, such as when the rear window demister or other electrical components are operating or the blower speed is set to a high setting

NOTE

- Battery voltage or battery performance is low
- Check engine warning lamp is illuminated or the  indicator lamp is blinking
- The selector lever is other than in the "D" (DRIVE) position (CVT)
- ASC operation indicator and ASC OFF indicator is turn on (for vehicles with CVT and ASC)
- ABS warning lamp is turn on
- Selector lever position indicator is blinking (CVT)
- In the following cases, the engine will not stop automatically even if  indicator lamp turn on.
 - Push the accelerator pedal
 - Brake booster vacuum pressure is low
 - Operate the steering wheel
 - Brake pedal is not sufficiently depressed (CVT)
 - Parking on steep hill (CVT)
 - Parking brake operates (CVT)
- On vehicles with M/T, do not rest your foot on the clutch pedal while driving because this will cause detection of clutch pedal switch malfunction and blinking of the  indicator lamp, and Auto Stop & Go (AS&G) system will not operate.

NOTE

- If the Auto Stop & Go (AS&G) system operates while the air conditioner is operating, both the engine and the air conditioning compressor will stop. Therefore, only the blower will operate, the windows may start to fog up. If this occurs, set the air conditioner to the demister position to restart the engine.
Refer to "Demisting of the windscreen and door windows: For quick demisting" on page 7-7, 7-14.
- If the windows become fogged up each time the engine is stopped, we recommend you to deactivate the Auto Stop & Go (AS&G) system by pressing the "Auto Stop & Go (AS&G) OFF" switch. Refer to "To deactivate" on page 6-25.
- If the air conditioner is operating, set the temperature control higher to lengthen the time that the engine is stopped automatically.

Automatically restarting the engine

E00627601324

On vehicles with M/T, depress the clutch pedal while the gearshift lever is in the "N" (Neutral) position. The  indicator lamp turns off and the engine restarts automatically.

Auto Stop & Go (AS&G) system*

On vehicles with CVT, Release the brake pedal. The (A) indicator lamp turns off and the engine restart automatically.

 **NOTE**

- On vehicles with M/T, do not move the gear-shift lever to a position other than the “N” (Neutral) position or do not release the clutch pedal while the engine is restarting automatically. The starter motor will stop and the engine will not restart automatically.
- If the engine does not restart automatically or if the engine stalls, the charge warning lamp and check engine warning lamp will illuminate.

If this occurs,

[On vehicles with M/T]

The engine will not restart even if the clutch pedal is depressed again. While depressing the brake pedal, fully depress the clutch pedal and turn the ignition switch to the “START” position or press the engine switch to start the engine.

 **NOTE**

[On vehicles with CVT]

The engine will not restart even if release the brake pedal again. Also, the (A) indicator blinks, and the buzzer sounds.

While depressing the brake pedal, move the selector lever to the “P” (PARK) or “N” (NEUTRAL) position and turn the ignition switch to the “START” position or press the engine switch to start the engine. After the engine is started, the buzzer stops.

But the (A) indicator is blinking until turning the ignition switch to the “LOCK” position or putting the operation mode in OFF.

For details, refer to “Starting” on page 6-15.

- The vehicles equipped with CVT have the function of preventing the unexpected start of the vehicle due to creeping, etc., by temporarily maintain the braking force applied when the engine restarts automatically. This function is deactivated if the selector lever is set into “N” (NEUTRAL) position. While the function is activated, you might hear operation noise from under the vehicle or feel a shock from the brake pedal. This indicates that the function is operating normally. It does not indicate a malfunction.

 **CAUTION**

- In the following cases, the engine will restart automatically even if the engine was stopped by the Auto Stop & Go (AS&G) system. Pay careful attention, otherwise an unexpected accident might occur when the engine restarts.
 - Vehicle speed is 3 km/h or higher when coasting down a slope
 - Brake booster vacuum pressure is low because the brake pedal is depressed repeatedly or depressed harder than usual
 - Engine coolant temperature is low
 - When the air conditioner is operated by pressing the air conditioning switch
 - When the preset temperature of the air conditioner is changed significantly
 - When the air conditioner is operated in AUTO mode where the temperature control is set to the max. hot or the max. cool (for vehicles with automatic air conditioning)
 - When the air conditioner is ON, the passenger compartment temperature rises and the air conditioning compressor operates to lower the temperature
 - When the air conditioner is changed to the demister position
 - Electric power consumption is high, such as when the rear window demister or other electrical components are operating or the blower speed is set to a high setting
 - Push the accelerator pedal (CVT)
 - Battery voltage or battery performance is low

Auto Stop & Go (AS&G) system*

6

CAUTION

- Operate the steering wheel
- After the engine stop, 3 minute elapse (CVT)
- Move the selector lever to the “R” (REVERSE) position (CVT)
- Move the selector lever from the “N” (NEUTRAL) to “D” (DRIVE) position (CVT)
- Driver’s seat belt is unfastened
- Driver’s door is opened

NOTE

- In the following cases, the engine will not restart automatically.
 - Bonnet is opened
 - On vehicles with M/T, while the engine is stopped automatically, “Auto Stop & Go (AS&G) OFF” switch is pressed to deactivate the “Auto Stop & Go (AS&G) OFF” system.
- When the engine restarts automatically, decrease in audio volume may temporarily be experienced. This does not indicate a malfunction.
- While the engine is stopped automatically, the air volume change of the air conditioner may temporarily be experienced. This does not indicate a malfunction.

NOTE

- On vehicles with CVT, while the engine is stopped automatically, if the selector lever is moved to the “P” (PARK) position quickly with the brake pedal firmly depressed, the engine does not restart automatically even if you release the brake pedal. If this occurs, the (A) indicator will blink to inform the driver.
If you want to restart the engine, depress the brake pedal again.
If you want to put the operation mode in OFF, press the engine switch without depressing the brake pedal. (Vehicles equipped with the keyless operation system)

To deactivate

E00627701312

The Auto Stop & Go (AS&G) system is automatically activated when the ignition switch is turned to the “ON” position or the operation mode put in ON. You can deactivate the system by pressing the “Auto Stop & Go (AS&G) OFF” switch.

When the Auto Stop & Go (AS&G) system is deactivated, the  indicator will be turned on.

To reactivate the Auto Stop & Go (AS&G) system, press the “Auto Stop & Go (AS&G) OFF” switch, the indicator will turn off.

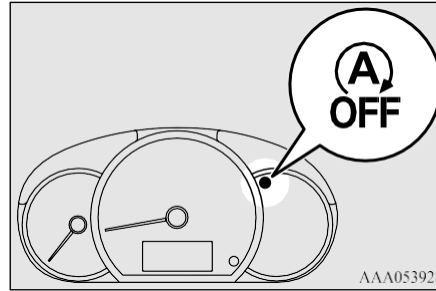
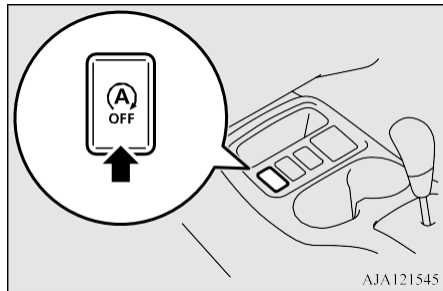

NOTE

- This indicator lamp will also turn on for a few seconds when the ignition switch is turned to the “ON” position or the operation mode put in ON.

If the indicator lamp blinks while driving

E00627801238

If the  indicator lamp blinks, the Auto Stop & Go (AS&G) system is malfunctioning and will not operate.

Consult an authorised MITSUBISHI MOTORS dealer immediately.

Manual transmission*

Manual transmission*

E00602002454

The shift pattern is shown on the gearshift lever knob. Press the clutch pedal all the way down while shifting gears. To start off, press the clutch pedal all the way down and shift into 1st or “R” (Reverse) position, operating the gearshift lever slowly. Then gradually release the clutch pedal while depressing the accelerator pedal.

6

CAUTION

- Do not put the gearshift lever into the reverse position while the vehicle is moving forward. Doing so could damage the transmission.
- Do not rest your foot on the clutch pedal while driving. Doing so could cause rapid wear to the clutch.
- Do not coast in the “N” (Neutral) position.
- Do not use the gearshift lever as a handrest, because this can result in premature wear of the transmission shift forks.

NOTE

- During cold weather, shifting may be difficult until the transmission lubricant has warmed up. This is normal and not harmful to the transmission.

Automatic transmission INVECS-III CVT (Intelligent & Innovative Vehicle Electronic Control System III)*

NOTE

- If it is hard to shift into 1st, depress the clutch pedal again; the shift will then be easier to make.
- To shift into the “R” (Reverse) position from 5th gear, move the gearshift lever to the “N” (Neutral) position, and then move it to the “R” (Reverse) position.
- To avoid grinding noises when shifting into reverse, wait approximately 3 seconds with the clutch pedal depressed when the vehicle is stationary.

6

Shift point	Speed limit
1st gear	45 km/h
2nd gear	85 km/h
3rd gear	130 km/h
4th gear	170 km/h

Use 5th gear whenever vehicle speed allows, for maximum fuel economy.

**Automatic transmission
INVECS-III CVT (Intelligent & Innovative Vehicle
Electronic Control System
III)***

E00602100275

The CVT will automatically and continuously change its gear ratio depending on road and driving conditions. This helps achieve smooth driving and excellent fuel efficiency.

Changing gears

E00610600312

Always use care to change the gear with the vehicle speed matched to the engine speed. Proper shifting will improve fuel economy and prolong engine life.

Avoid shifting down at high speed, as this may cause excessive engine speed and damage the engine.

Possible driving speed

E00610803315

Avoid shifting down at high speed, as this may cause excessive engine speed and damage the engine.

Automatic transmission INVECS-III CVT (Intelligent & Innovative Vehicle Electronic Control System III)*

Selector lever operation

E00602201521

The CVT selects an optimum gear ratio automatically, depending on the speed of the vehicle and the position of the accelerator pedal.

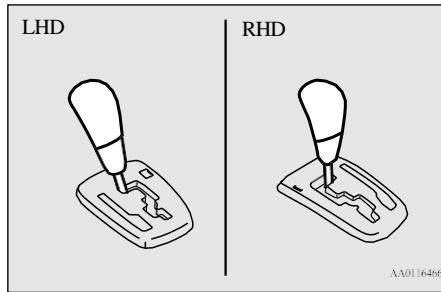

LHD (5 positions)

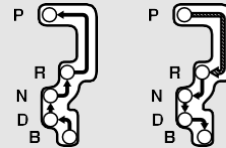

LHD (6 positions)

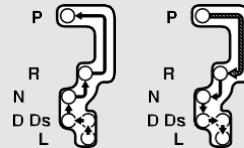

RHD

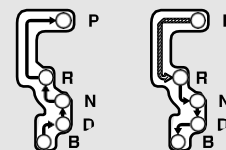

AJE101693

↓	While depressing the brake pedal, move the selector lever through the gate.
↓	Move the selector lever through the gate.

WARNING

- Always depress the brake pedal when shifting the selector lever into the other position from the “P” (PARK) or “N” (NEUTRAL) position. Never put your foot on the accelerator pedal while shifting the selector lever from the “P” (PARK) or “N” (NEUTRAL) position.

NOTE

- To avoid erroneous operation, move the selector lever firmly into each position and briefly hold it there. Always check the position shown by the selector lever position display after moving the selector lever.
- If the brake pedal is not depressed and held, the shift-lock device activates to prevent the selector lever from being moved from the “P” (PARK) position.

6

When the selector lever cannot be shifted from the “P” (PARK) position

E0062900338

When the selector lever cannot be shifted from the “P” (PARK) position while the brake pedal is pressed and held down with the ignition switch or the operation mode in ON, the battery may be flat

Automatic transmission INVECS-III CVT (Intelligent & Innovative Vehicle Electronic Control System III)*

or the shift-lock mechanism may be malfunctioning.

Immediately have your vehicle checked by an authorised MITSUBISHI MOTORS dealer.

If you need to move the vehicle, shift the selector lever as follows.

For LHD vehicles

6

1. Make sure the parking brake is fully applied.
2. Stop the engine if it is running.
3. Insert a straight blade (or minus) screwdriver with a cloth over its tip into the notch (A) of the cover. Pry gently as shown to remove the cover.

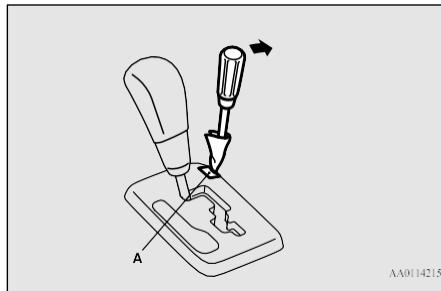

4. Depress the brake pedal with the right foot.

5. Insert a straight blade (or minus) screwdriver in the shift-lock release hole (B). Shift the selector lever to the “N” (NEUTRAL) position while pressing the straight blade (or minus) screwdriver down.

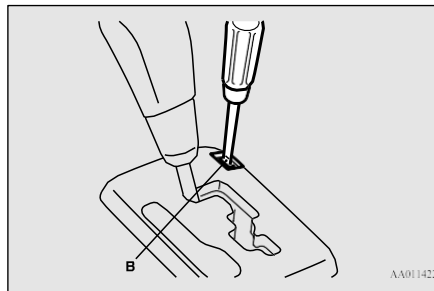

For RHD vehicles

1. Make sure the parking brake is fully applied.
2. Stop the engine if it is running.
3. Depress the brake pedal with the right foot.
4. Insert straight blade (or minus) screwdriver in the shift-lock release hole (A). Shift the selector lever to the “N” (NEUTRAL) position while pressing the straight blade (or minus) screwdriver down.

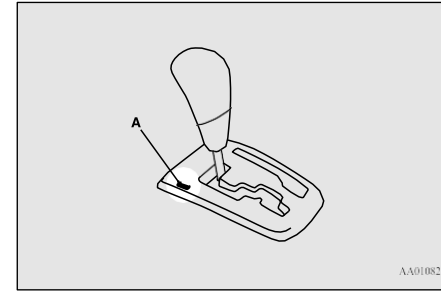

Selector lever position display

E00602300411

When the ignition switch is turned to the “ON” position or the operation mode is put in ON, the position of the selector lever is indicated in the multi-information display.

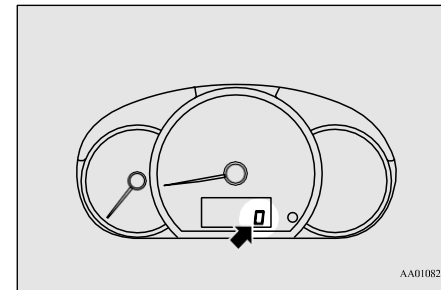

Automatic transmission INVECS-III CVT (Intelligent & Innovative Vehicle Electronic Control System III)*

Selector lever positions

E00602401679

“P” PARK

This position locks the transmission to prevent the vehicle from moving. The engine can be started in this position.

“R” REVERSE

This position is to back up.

⚠ CAUTION

- Never shift into the “P” (PARK) or “R” (REVERSE) position while the vehicle is in motion to avoid a transmission damage.

“N” NEUTRAL

At this position the transmission is disengaged. It is the same as the neutral position on a manual transmission, and should only be used when the vehicle is stationary for an extended length of time during driving, such as in a traffic jam.

⚠ WARNING

- Never move the selector lever to the “N” (NEUTRAL) position while driving. A serious accident could occur since you could accidentally move the lever into the “P” (PARK) or “R” (REVERSE) position or you will lose engine braking.
- On a gradient the engine should be started in the “P” (PARK) position, not in the “N” (NEUTRAL) position.
- To prevent rolling, always keep your foot on the brake pedal when the vehicle is in “N” (NEUTRAL) position, or when shifting into or out of “N” (NEUTRAL) position.

“D” DRIVE

This position is used for most city and highway driving. The transmission will automatically and continuously change its gear ratio depending on road and driving conditions.

⚠ CAUTION

- To prevent transmission damage, never shift into the “D” (DRIVE) position from the “R” (REVERSE) position while the vehicle is in motion.

“Ds” DOWNSHIFT & SPORTY DRIVING (6 Position Type)

Use when engine braking is needed, or for high-power sport drive.

“B” BRAKE (5 Position Type)

This position is for use when light engine braking at high-speed is needed, or driving up very steep hills and for engine braking at low speeds when descending steep gradients.

6**“L” LOW (6 Position Type)**

This position is for driving up very steep hills and for engine braking at low speeds when driving down steep hills.

⚠ WARNING

- This position can be used for maximum engine braking. Be very careful not to shift into “L” (LOW) suddenly. Sudden engine braking may cause the tyres to skid. Select this position according to the road conditions and vehicle speed.

Automatic transmission INVECS-III CVT (Intelligent & Innovative Vehicle Electronic Control System III)*

When a malfunction occurs in the CVT

E0063200026

When the selector lever position indicator blinks

E00632101297

6

When the selector lever position indicator blinks while you are driving, there could be a malfunction in the automatic transmission system or CVT fluid temperature becomes abnormally high.

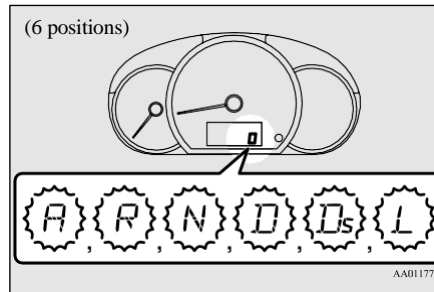
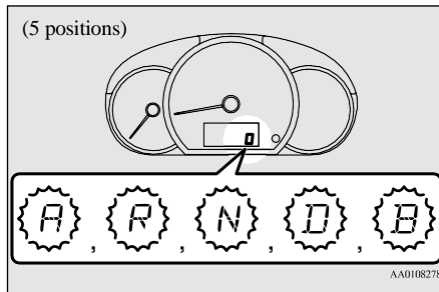

NOTE

- The "A" indicator on the selector lever position display will only blink if there is a problem with the CVT position switch. It is not seen during normal driving.

CAUTION

- If a malfunction occurs in the CVT while driving, the indicator lamp will blink. In this case, immediately park your vehicle in a safe place and follow these procedures: [If the indicator lamp blinks rapidly (once per second), the CVT fluid is overheating.] Park your vehicle in a safe place but do not turn off the engine. Move the selector lever to the "P" (PARK) position and open the bonnet. Keep the engine, idling. After a while, move the selector lever into any position other than "P" (PARK) position and confirm that the indicator lamp stops blinking. It is safe to continue driving if the indicator lamp no longer blinks. If the indicator lamp continues blinking, contact an authorised MITSUBISHI MOTORS dealer immediately. [If the indicator lamp blinks slowly (once per 2 seconds), the CVT safety device may be operating due to a malfunction.] Have the vehicle inspected by an authorised MITSUBISHI MOTORS dealer immediately.

Automatic transmission INVECS-III CVT (Intelligent & Innovative Vehicle Electronic Control System III)*

Operation of the CVT

E00602601655

CAUTION

- Before selecting a position with the engine running and the vehicle stationary, fully depress the brake pedal to prevent the vehicle from creeping.
The vehicle will begin to move as soon as the CVT is engaged, especially when the engine speed is high, at fast idle or with the air conditioning operating, the brakes should only be released when you are ready to drive away.
- Depress the brake pedal with the right foot at all times.
Using the left foot could cause driver movement delay in case of an emergency.
- To prevent sudden acceleration, never race the engine when shifting from the “P” (PARK) or “N” (NEUTRAL) position.
- Operating the accelerator pedal while the other foot is resting on the brake pedal will affect braking efficiency and may cause premature wear of brake pads.

CAUTION

- Use the selector lever in the correct shift position accordance with driving conditions. Never coast downhill backward with the selector lever in the “D” (DRIVE), “Ds” (DOWNSHIFT & SPORTY DRIVING/6 Position Type), “B” (BRAKE/5 Position Type), “L” (LOW/6 Position Type) position or coast forward with the selector lever in the “R” (REVERSE) position.

The engine may stop and the unexpected increase in brake pedal effort and steering wheel effort could lead to an accident.

- Do not race the engine with brake pedal pressed when the vehicle is stationary. This can damage the CVT.

Also, when you depress the accelerator pedal while holding down the brake pedal with the selector lever in the “D” (DRIVE) position, the engine revolutions may not rise as high as when performing the same operation with the selector lever in the “N” (NEUTRAL) position.

Passing acceleration

E00602700112

To gain extra acceleration in “D” (DRIVE) position push the accelerator to the floor. The CVT will automatically downshift.

Uphill/downhill driving

E00603000125

DRIVING UPHILL

The transmission prevents unnecessary upshifts even when the accelerator pedal is released and ensures smooth driving.

DRIVING DOWNHILL

According to the conditions, the transmission will automatically shift to a lower gear ratio to achieve stronger engine braking. This may help reduce your need to use the service brake.

Waiting

E00602801181

For short waiting periods, such as at traffic signals the vehicle can be left in selector lever position and held stationary with the service brake.

For longer waiting periods with the engine running, place the selector lever in the “N” (NEUTRAL) position and apply the parking brake, while holding the vehicle stationary with the service brake.

6

Braking

CAUTION

- Never hold the vehicle stationary while in CVT on a hill with the accelerator, always apply the parking brake and/or service brake.

Parking

6

To park the vehicle, first bring it to a complete stop, fully engage the parking brake, and then move the selector lever to the “P” (PARK) position.

If you are going to leave the vehicle unattended, always switch off the engine and carry the key.

NOTE

- On a slope, be sure to apply the parking brake before moving the selector lever to the “P” (PARK) position. If you move the selector lever to the “P” (PARK) position before applying the parking brake, it may be difficult to disengage the selector lever from the “P” (PARK) position when next you drive the vehicle, requiring application of a strong force to the selector lever to move from the “P” (PARK) position.

When the CVT makes no speed change

E00603101282

If the transmission does not change speeds while driving, or your vehicle does not pick up enough speed when starting on an uphill slope, it may be that there is something unusual happening in the transmission, causing a safety device to activate. We recommend you to have your vehicle checked immediately.

Braking

E00607001856

All the parts of the brake system are critical to safety. Have the vehicle serviced by an authorised MITSUBISHI MOTORS dealer at regular intervals according to the service booklet.

CAUTION

- Avoid driving habits that cause heavy braking and never “ride” the brakes by resting your foot on the brake pedal while driving. It causes brake overheating and fade.

Brake system

The service brake is divided into two brake circuits. And your vehicle is equipped with

power brakes. If one brake circuit fails, the other is available to stop the vehicle. If your vehicle should lose the power assist for some reason, the brakes will still work. In these situations, even if the brake pedal moves down to the very end of its possible stroke or resists being depressed, keep depressing the brake pedal down harder and further than usual; stop driving as soon as possible and have the brake system repaired at an authorised MITSUBISHI MOTORS dealer.

WARNING

- Do not turn off the engine while your vehicle is in motion. If you turn off the engine while driving, the power assistance for the braking system will stop working and your brakes will not work effectively.
- If the power assist is lost or if either brake hydraulic system stops working properly, have your vehicle checked immediately, take your vehicle to an authorised MITSUBISHI MOTORS dealer immediately.

Warning lamp

The brake warning lamp illuminates to indicate a fault in the braking system. Refer to “Brake warning lamp” on page 5-14.

When brakes are wet

Check the brake system while driving at a low speed immediately after starting, especially when the brakes are wet, to confirm they work normally.

A film of water can be formed on the brake discs or brake drums and prevent normal braking after driving in heavy rain or through large puddles, or after the vehicle is washed. If this occurs, dry the brakes out by driving slowly while lightly depressing the brake pedal.

When driving downhill

It is important to take advantage of the engine braking by shifting to a lower shift position while driving on steep downhill roads in order to prevent the brakes from overheating.

WARNING

- Do not leave any objects near the brake pedal or let a floor mat slide under it; doing so could prevent the full pedal stroke that would be necessary in an emergency. Make sure that the pedal can be operated freely at all times. Make sure the floor mat is securely held in place.

Brake pads

- New brakes need to be broken-in by moderate use for the first 200 km. Avoid hard braking situations.
- The disc brakes are provided with a warning device which emits a shrieking metallic sound while braking if the brake pads have reached their limit. If you hear this sound, have the brake pads replaced immediately by your MITSUBISHI MOTORS dealer.

WARNING

- Driving with worn brake pads will make it harder to stop, and can cause an accident.

Hill start assist*

E00628001530

The hill start assist makes it easy to start off on a steep uphill slope by preventing the vehicle from moving backwards. It keeps the braking force for approximately 2 seconds when you move your foot from the brake pedal to the accelerator pedal.

CAUTION

- Do not overly rely on the hill start assist to prevent backwards movement of the vehicle. Under certain circumstances, even when hill start assist is activated, the vehicle may move backwards if the brake pedal is not sufficiently depressed, if the vehicle is heavily loaded, or if the road is very steep or slippery.
- The hill start assist is not designed to keep the vehicle stopped in place on uphill slopes for more than 2 seconds.
- When facing uphill, do not rely on using the hill start assist to maintain a stopped position as an alternative to depressing the brake pedal. Doing so could cause an accident.
- Do not turn the ignition switch to the "LOCK" or "ACC" position or do not put the operation mode in ACC or OFF while the hill start assist is operating. The hill start assist could stop operating, which could result in an accident.

6

To operate

E00628101704

1. Stop the vehicle completely using the brake pedal.
2. On vehicles with M/T, place the gearshift lever into the 1st position. On vehicles with CVT, place the selector lever into the "D" (DRIVE) position.

Brake assist system*

NOTE

- When reversing on an uphill slope, place the gearshift lever or selector lever into the “R” position.

3. Release the brake pedal and the hill start assist will maintain the braking force applied while stopped for approximately 2 seconds.

4. Depress the accelerator pedal and the hill start assist will gradually decrease the braking force as the vehicle starts moving.

NOTE

- The hill start assist is activated when all of the following conditions are met.
 - The engine is running.
(The hill start assist will not be activated while the engine is starting or immediately after the engine is started.)

NOTE

- On vehicles with M/T, the gearshift lever is in the following position.
[When starting an uphill slope forwards.]
The gearshift lever is in any position other than “R” (Reverse).
(The hill start assist will operate, even if the gearshift lever is in the “N” (Neutral) position.)
[When starting an uphill slope backwards.]
The gearshift lever is in the “R” (Reverse) position.
(The hill start assist will not operate when the gearshift lever is in the “N” (Neutral) position.)
- On vehicles with CVT, the selector lever is in any position other than “P” (PARK) or “N” (NEUTRAL).
- The vehicle is completely stationary, with the brake pedal depressed.
- The parking brake is released.
- The hill start assist will not operate if the accelerator pedal is depressed before the brake pedal is released.
- The hill start assist also operates when reversing on an uphill slope.
- When the hill start assist is activated, you may feel the operation sound or vibration from under the body.
This is a normal result of the hill start assist operation, and does not indicate a problem.

Warning indicator

E00628201486

If an abnormal condition occurs in the system, the indicator will turn on.

 - ASC indicator

CAUTION

- If the warning is turned on, the hill start assist will not operate. Start off carefully.
- Park your vehicle in a safe place and stop the engine.
Restart the engine and check whether the warning indicator went out, in which case the hill start assist is again working normally. If the warning remains displayed or reappears frequently, it is not necessary to stop the vehicle immediately, but the vehicle should be inspected by an authorised MITSUBISHI MOTORS dealer.

Brake assist system*

E00627001751

The brake assist system is a device assisting drivers who cannot depress the brake pedal firmly such as in emergency stop situations and provides greater braking force.

If the brake pedal is depressed suddenly, the brakes will be applied with more force than usual.

CAUTION

- The brake assist system is not a device designed to exercise braking force greater than its capacity. Make sure to always keep a sufficient distance between your vehicle and a vehicle in front of you without relying too much on the brake assist system.

NOTE

- Once the brake assist system is operational, it maintains great braking force even if the brake pedal is lightly released. To stop its operation, completely remove your foot from the brake pedal.
- When the brake assist system is in use while driving, you may feel as if the depressed brake pedal is soft, the pedal moves in small motions in conjunction with the operation noise, or the vehicle body and the steering wheel vibrate. This occurs when the brake assist system is operating normally and does not indicate faulty operation. Continue to depress the brake pedal.
- When the anti-lock brake system warning lamp is illuminated, the brake assist system is not functioning.

Emergency stop signal system*

E00626001187

This is a device that reduces the possibility of rear end collisions by the rapid and automatic blinking of the hazard warning lamps to alert vehicles approaching from behind during sudden braking. When the emergency stop signal system operates, the hazard warning indicator lamp in the instrument cluster blinks rapidly at the same time.

CAUTION

- On vehicles with the anti-lock brake system (ABS), if the ABS warning lamp is illuminated, the emergency stop signal system may not operate. Refer to “ABS warning lamp” on page 6-36.

NOTE

- [Activating condition for the emergency stop signal system]
It activates when all of the following conditions are met.
 - The vehicle speed is approximately 55 km/h or higher.

Emergency stop signal system*

NOTE

- The brake pedal has been depressed, and the system judges that it was sudden braking from the vehicle deceleration and the operating condition of the ABS (if so equipped).

[Deactivating condition for the emergency stop signal system]

It deactivates when one of the following conditions is met.

- The brake pedal is released.
- The hazard warning flasher switch is pressed.
- The system judges that it was not sudden braking from the vehicle deceleration and the operating condition of the ABS (if so equipped).

6

Anti-lock brake system (ABS)*

E00607101437

The anti-lock brake system (ABS) helps prevent the wheels from locking up when braking. This helps maintain vehicle drivability and steering wheel handling.

Anti-lock brake system (ABS)*

Driving hints

- Always keep a safe distance from the vehicle in front of you. Even if your vehicle is equipped with the ABS, leave a greater braking distance when:
 - Driving on gravel or snow-covered roads.
 - Driving with tyre chains installed.
 - Driving on uneven road surfaces.
- Operation of ABS is not restricted situations where brakes are applied suddenly. This system may also prevent the wheels from locking when you drive over man-holes, steel roadwork plates, road markings, or any uneven road surface.
- When the ABS is in use, you may feel the brake pedal pulsation and the vibrations of the vehicle body and steering wheel. It may also feel as if the pedal resists being pressed.

In this situation, simply hold the brake pedal down firmly. Do not pump the brake, which will result in reduced braking performance.
- An operation noise is emitted from the engine compartment or feel a shock from the brake pedal when start driving immediately after starting the engine. These are normal sound or operation that the ABS makes when performing a self-check. It does not indicate a malfunction.

- The ABS can be used after the vehicle has reached a speed over approximately 10 km/h. It stops working when the vehicle slows below approximately 5 km/h.

CAUTION

- The ABS cannot prevent accidents. It is your responsibility to take safety precautions and to drive carefully.
- To prevent failure of the ABS, be sure all 4 wheels and tyres are the same size and the same type.
- Do not install any aftermarket limited slip differential (LSD) on your vehicle. The ABS may stop functioning properly.

ABS warning lamp

E00607201252

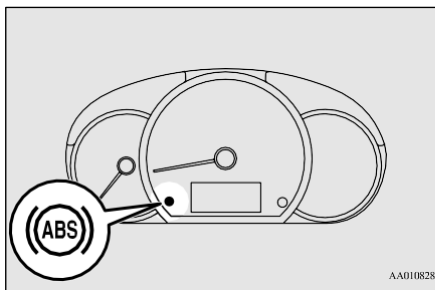

AA0108281

If there is a malfunction in the system, the ABS warning lamp will come on.

Under normal conditions, the ABS warning lamp comes on when the ignition switch is turned to the “ON” position or the operation mode is put in ON and goes off a few seconds later.

CAUTION

- Any of the following indicates that the ABS is not functioning and only the standard brake system is working. (The standard brake system is functioning normally.) If this happens, please contact your nearest authorised MITSUBISHI MOTORS dealer for inspection.
 - When the ignition switch is turned to the “ON” position or the operation mode is put in ON, the warning lamp does not come on or it remains on and does not go off.
 - The warning lamp comes on while driving

If the warning lamp illuminates while driving

E00607302511

If only the ABS warning lamp illuminates

Avoid hard braking and high-speed driving. Stop the vehicle in a safe place. Restart the engine and check to see whether the lamp goes out after a few minutes driving;

if it then remains off during driving, there is no problem.

However, if the warning lamp do not disappear, or if they come on again when the vehicle is driven, have the vehicle checked by an authorised MITSUBISHI MOTORS dealer as soon as possible.

If the ABS warning lamp and brake warning lamp illuminate at the same time

The ABS and brake force distribution function may not work, so hard braking could make the vehicle unstable.

Avoid hard braking and high-speed driving. Stop the vehicle in a safe place and contact an authorised MITSUBISHI MOTORS dealer.

After driving on icy roads

E00618800206

After driving on snow or icy roads, remove any snow and ice which may have be left around the wheels. On vehicles that have an ABS, be careful not to damage the wheel speed sensors (A) or the cables located at each wheel.

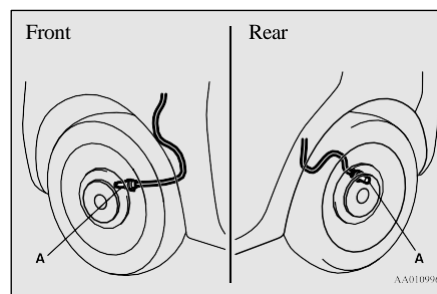

Electric power steering system (EPS)

E00629201395

The power steering system operates while the engine is running. It helps reduce the effort needed to turn the steering wheel.

The power steering system has mechanical steering capability in case the power assist is lost. If the power assist is lost for some reason, you will still be able to steer your vehicle, but you will notice it takes much more effort to steer. If this happens, have your vehicle inspected at an authorised MITSUBISHI MOTORS dealer.

Electric power steering system (EPS)

WARNING

- Do not stop the engine while the vehicle is moving. Stopping the engine would make the steering wheel extremely hard to turn, possibly resulting in an accident.

NOTE

- During repeated full-lock turning of the steering wheel (for example, while you are manoeuvring the vehicle into a parking space), a protection function may be activated to prevent overheating of the power steering system. This function will make the steering wheel gradually harder to turn. In this event, limit your turning of the steering wheel for a while. When the system has cooled down, the steering effort will return to normal.
- If you turn the steering wheel while the vehicle is stationary with the headlamps on, the headlamps may become dim. This behaviour is not abnormal. The headlamps will return to their original brightness after a short while.

6

Active stability control (ASC)*

Electric power steering system warning lamp

6

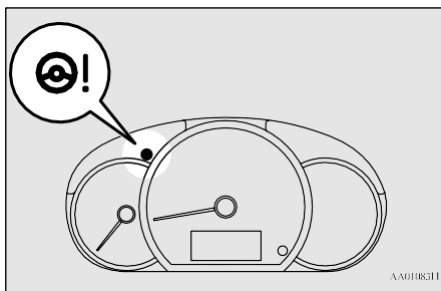

If there is a malfunction in the system, the warning lamp will come on.

Under normal conditions, the warning lamp comes on when the ignition switch is turned to the “ON” position or the operation mode is put in ON, and goes off after the engine has started.

CAUTION

- If the warning lamp comes on while the engine is running, have the vehicle inspected by an authorised MITSUBISHI MOTORS dealer as soon as possible. It may become harder to turn the steering wheel.

Active stability control (ASC)*

E00616701657

The active stability control (ASC) takes over-all control of the anti-lock brake system, traction control function and stability control function to help maintain the vehicle’s control and traction. Please read this section in conjunction with the page on the anti-lock brake system, traction control function and stability control function.

Anti-lock brake system (ABS) → P.6-35

Traction control function → P.6-38

Stability control function → P.6-39

CAUTION

- Do not over-rely on the ASC. Even the ASC cannot prevent the natural laws of physics from acting on the vehicle. This system, like any other system, has limits and cannot help you to maintain traction and control of the vehicle in all circumstances. Reckless driving can lead to accidents. It is the driver’s responsibility to drive carefully. This means into account the traffic, road and environmental conditions.
- Be sure to use the same specified type and size of tyre on all 4 wheels. Otherwise, the ASC may not work properly.

CAUTION

- Do not install any aftermarket limited slip differential (LSD) on your vehicle. The ASC may stop functioning properly.

NOTE

- An operation noise may be emitted from the engine compartment in the following situations. The sound is associated with checking the operations of the ASC. At this time, you may feel a shock from the brake pedal if you depress it. These do not indicate a malfunction.
 - When the ignition switch is turned to the “ON” position.
 - When the vehicle is driven for a while after the engine is turned on.
- When the ASC is activated, you may feel a vibration in the vehicle body or hear a whining sound from the engine compartment. This indicates that the system is operating normally. It does not indicate a malfunction.
- When the anti-lock brake system warning lamp is illuminated, the ASC is not active.

Traction control function

E00619000133

On slippery surfaces, the traction control function prevents the drive wheels from spinning excessive, thus helping the vehicle to start moving from a stopped condition. It also

provides sufficient driving force and steering performance as the vehicle turns while pressing the acceleration pedal.

CAUTION

- When driving a vehicle on a snowy or icy road, be sure to install snow tyres and drive the vehicle at moderate speeds.

Stability control function

E00619100017

The stability control function is designed to help the driver maintain control of the vehicle on slippery roads or during rapid steering maneuvers. It works by controlling the engine output and the brake on each wheel.



NOTE

- The stability control function operates at speeds of about 15 km/h or higher.

“ASC OFF” switch

E00619201943

The ASC is automatically activated when the ignition switch is turned to the “ON” position or the operation mode is put in ON. You can deactivate the system by pressing down the “ASC OFF” switch for 3 seconds or longer.

When the ASC is deactivated, the  indicator will turn on. To reactivate the ASC, momentarily press the “ASC OFF” switch; the  indicator is turned off.

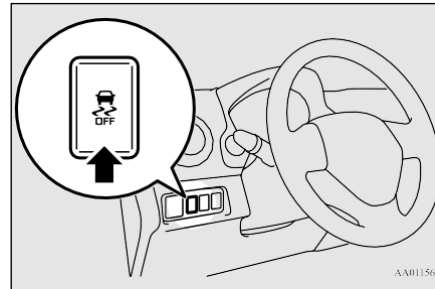

AA0115629

CAUTION

- For safety reasons, the “ASC OFF” switch should be operated when your vehicle is stopped.
- Be sure to keep the ASC on while driving in normal circumstances.

Active stability control (ASC)*

NOTE

- When moving out of mud, sand or fresh snow, pressing the accelerator pedal may not allow the engine speed to increase. In such situations, temporarily turning off the ASC with the “ASC OFF” switch will make it easier to move out your vehicle.
- Using the “ASC OFF” switch turns off both the stability control function and the traction control function.
- If you continue to press the “ASC OFF” switch after the ASC is turned off, the “mistaken operation protection function” will activate and the ASC will turn back on.

6

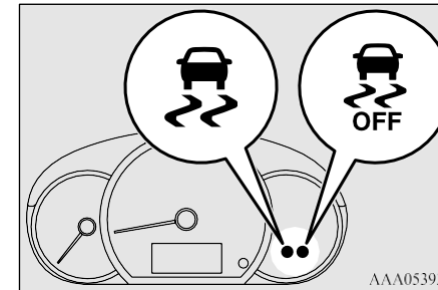

ASC operation indicator or ASC OFF indicator

E00619301696



AAA053931

Cruise control*



-  - ASC indicator
The indicator will blink when the ASC is operating.
-  - ASC OFF indicator
This indicator will turn on when the ASC is turned off with the “ASC OFF” switch.

6

CAUTION

- When  indicator blinks, ASC is operating, which means that the road is slippery or that your vehicle’s wheels are beginning to slip. If this happens, drive slower with less accelerator input.



NOTE

- The  indicator may turn on when you start the engine. This means that the battery voltage momentarily dropped when the engine was started. It does not indicate a malfunction, provided that the display goes out immediately.
- When a compact spare tyre has been put on your vehicle, the gripping ability of the tyre will be lower, making it more likely that the  indicator will blink.

ASC warning indicator

E00619400629

If an abnormal condition occurs in the system, the indicators will turn on.

-  - ASC indicator
-  - ASC OFF indicator

CAUTION

- The system may be malfunctioning.
Park your vehicle in a safe place and stop the engine.
Restart the engine and check whether the indicator go out. If they go out, there is no abnormal condition. If they do not go out or appears frequently, it is not necessary to stop the vehicle immediately, but have your vehicle checked at an authorised MITSUBISHI MOTORS dealer.

Towing

E00624401217

CAUTION

- When towing the vehicle with only the front wheels or only the rear wheels raised off the ground, do not place the ignition switch in the “ON” position or do not put the operation mode in ON. Placing the ignition switch in the “ON” position or putting the operation mode in ON could cause the ASC to operate, resulting in an accident.
Note that the correct towing method depends on the transmission type and the vehicle’s drive configuration.
For details, refer to “Towing” on page 8-13.

Cruise control*

E00609101109

Cruise control is an automatic speed control system that keeps a set speed. It can be activated at about 40 km/h or more.

CAUTION

- When you do not wish to drive at a set speed, turn off the cruise control for safety.
- Do not use cruise control when driving conditions will not allow you to stay at the same speed, such as in heavy traffic or on roads that are winding, icy, snow-covered, wet, slippery, on a steep downhill slope.

Cruise control*

CAUTION

- On vehicles with M/T, do not move the gear-shift lever to the “N” (Neutral) position while driving at a set speed without depressing the clutch pedal. The engine will run too fast and might be damaged.

NOTE

- Cruise control may not be able to keep your speed on uphill or downhill.
- Your speed may decrease on a steep uphill. You may use the accelerator pedal if you want to stay at your set speed.
- Your speed may increase to more than the set speed on a steep downhill. You have to use the brake to control your speed. As a result, the set speed driving is deactivated.

Cruise control switches

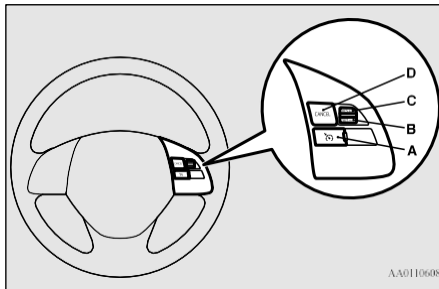

A- CRUISE CONTROL ON/OFF switch

Used to turn on and off the cruise control.

B- SET - switch

Used to reduce the set speed and to set the desired speed.

C- RES + switch

Used to increase the set speed and to return to the original set speed.

D- CANCEL switch

Used to deactivate the set speed driving.

NOTE

- When operating the cruise control switches, press the cruise control switches correctly. The set speed driving may be deactivated automatically if two or more switches of the cruise control are pressed at the same time.

To activate

1. With the ignition switch in the “ON” position or the operation mode in ON, press the CRUISE CONTROL ON/OFF switch (A) to turn on the cruise control. The indicator lamp in the meter cluster will come on.

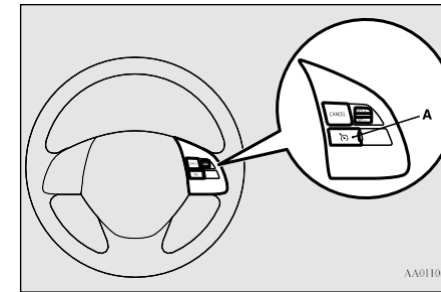

6

Indicator lamp



2. Accelerate or decelerate to your desired speed, then push down and release the SET - switch (B) when the indicator lamp is illuminated. The vehicle will then maintain the desired speed.

Cruise control*

6

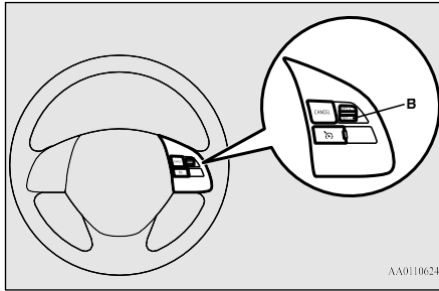

AA0110624

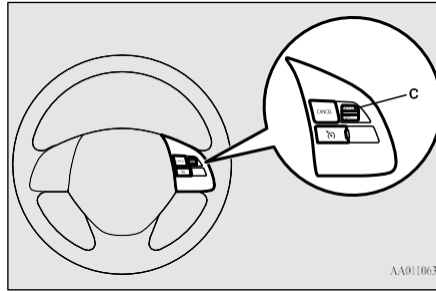

AA0110637

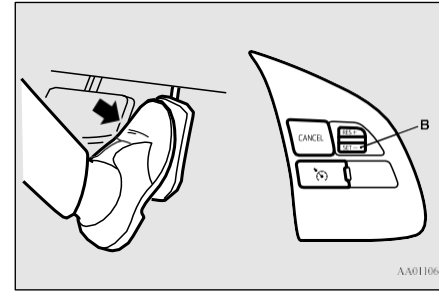

AA0110640

NOTE

- When you release the SET - switch (B), the vehicle speed will be set.

To increase the set speed

E00609400668

There are 2 ways to increase the set speed.

RES + switch

Push up and hold the RES + switch (C) while driving at the set speed, and your speed will then gradually increase.

When you reach your desired speed, release the switch. Your new cruising speed is now set.

To increase your speed in small amounts, push up the RES + switch (C) for less than about 1 second and release it.

Each time you press the RES + switch (C), your vehicle will go about 1.6 km/h faster.

Accelerator pedal

While driving at the set speed, use the accelerator pedal to reach your desired speed and then push down the SET - switch (B) and release the switch momentarily to set a new desired cruising speed.

To decrease the set speed

E00609500584

There are 2 ways to decrease the set speed.

SET - switch

Push down and hold the SET - switch (B) while driving at the set speed, and your speed will slow down gradually.

When you reach your desired speed, release the switch. Your new cruising speed is now set.

Cruise control*

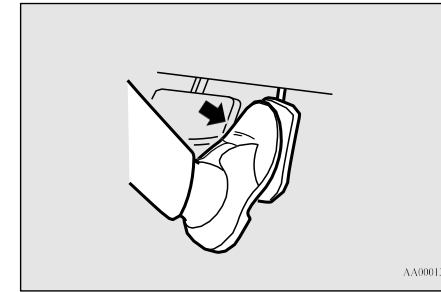
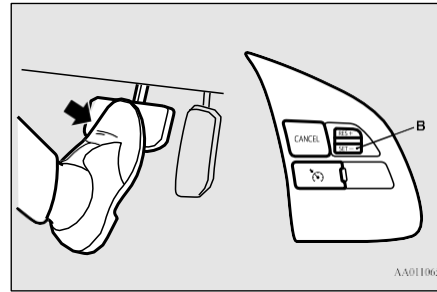
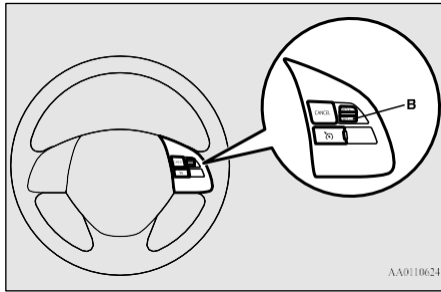

6

To slow down your speed in small amounts, push down the SET - switch (B) for less than about 1 second and release it. Each time you push down the SET - switch (B), your vehicle will slow down by about 1.6 km/h.

Brake pedal

While driving at the set speed, use the brake pedal, which disengages the cruise control, then push down the SET - switch (B) and release the switch momentarily to set a new desired cruising speed.

To temporarily increase or decrease the speed

E00609600194

To temporarily increase the speed

Depress the accelerator pedal as you would normally. When you release the pedal, you will return to your set speed.

NOTE

- In some driving conditions, the set speed driving may be deactivated. If this happens, refer to “To activate” on page 6-41 and repeat the speed setting procedure.

To temporarily decrease the speed

Depress the brake pedal to decrease the speed. To return to the previously set speed, push up the RES + switch (C). Refer to “To resume the set speed” on page 6-44.

Cruise control*

6

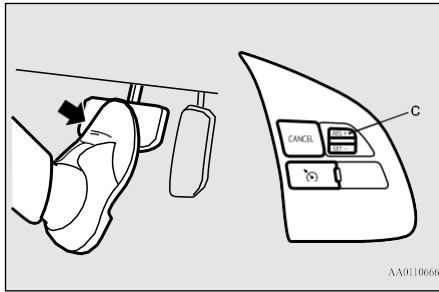

The set speed driving is deactivated automatically in any of the following ways.

- When you depress the clutch pedal (on vehicles with M/T).
- When your speed slows to about 15 km/h or more below the set speed because of a hill, etc.
- When your speed slows to about 40 km/h or less.

CAUTION

- When the set speed driving is deactivated automatically in any situation other than those listed above, there may be a system malfunction. Press the CRUISE CONTROL ON/OFF switch to turn off the cruise control and have your vehicle inspected by an authorised MITSUBISHI MOTORS dealer.

To deactivate

E00609702522

The set speed driving can be deactivated as follows:

- Press the CRUISE CONTROL ON/OFF switch (A) (Cruise control will be turned off.)
- Press the CANCEL switch (D).
- Depress the brake pedal.

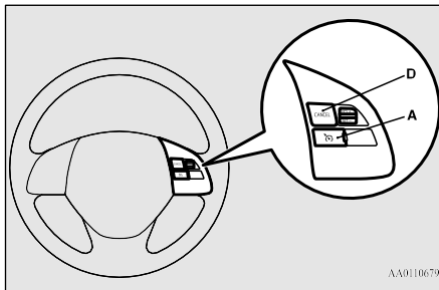

WARNING

- On vehicles equipped with CVT, although the set speed driving will be deactivated when shifting to the “N” (NEUTRAL) position, never move the selector lever to the “N” (NEUTRAL) position while driving. You would have no engine braking and could cause a serious accident.

Also, the set speed driving may be deactivated as follow:

- When the engine speed rises and approaches the tachometer’s red zone (the red-coloured part of the tachometer dial).

To resume the set speed

E00609802044

If the set speed driving is deactivated by the condition described in “To deactivate” on page 6-44, you can resume the previously set speed by push up the RES + switch (C) while driving at a speed of about 40 km/h or higher.

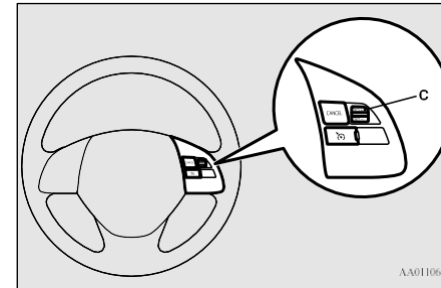

Under either of the following conditions, however, using the switch does not allow you

to resume the previously set speed. In these situations, repeat the speed setting procedure:

- The CRUISE CONTROL ON/OFF switch is pressed.
- The ignition switch is turned OFF or the operation mode is put in OFF.
- Indicator lamp goes off.

Tyre pressure monitoring system (TPMS)*

E00637100439

The tyre pressure monitoring system (TPMS) uses tyre inflation pressure sensors (A) on the wheels to monitor the tyre inflation pressures. The system only indicates when a tyre is significantly under-inflated.

The base tyre pressure can be set at desired value by the driver with the reset function execution. (The low pressure warning threshold is set based on the reset.)

The tyre inflation pressure sensor IDs for two sets of tyres can be registered by an authorised MITSUBISHI MOTORS dealer, and the valid ID set can be switched by the Multi-information display switch (It's beneficial in case of seasonal tyre change between summer tyre and winter tyre.)

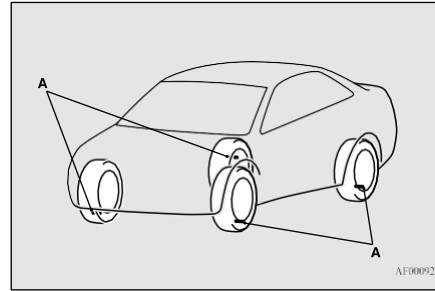

AF0009266

NOTE

- The tyre pressure monitoring system (TPMS) is not a substitute for regularly checking tyre inflation pressures. Be sure to check the tyre inflation pressures as described in “Tyres” on page 10-10.
- The tyre inflation pressure sensor (A) is installed in the illustrated location. Replace rubber air valve (B) with a new one when the tyre is replaced. For details, please contact an authorised MITSUBISHI MOTORS dealer.

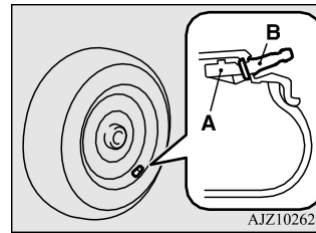

AJZ102626

Tyre pressure monitoring system (TPMS)*

NOTE

- The spare tyre which is the same as a normal tyre has a tyre inflation pressure sensor, so it can be used for tyre rotation.

Tyre pressure monitoring system warning lamp

E00637200384

6

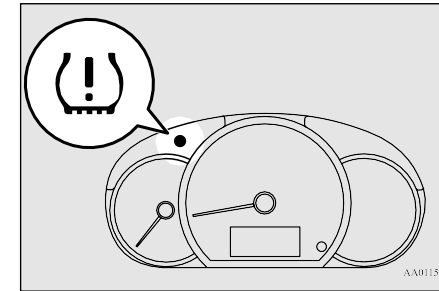

AA0115616

When the ignition switch is turned to the “ON” position, the tyre pressure monitoring system warning lamp normally illuminates and goes off a few seconds later.

If one or more of the vehicle tyres is significantly under-inflated, the warning lamp will remain illuminated while the ignition switch is in “ON”.

Refer to “If the warning lamp illuminates while driving” on page 6-47 and take the necessary measures.

Tyre pressure monitoring system (TPMS)*

⚠ CAUTION

- If the warning lamp does not illuminate when the ignition switch is turned to the “ON” position, it means that the tyre pressure monitoring system (TPMS) is not working properly. Have the system inspected by an authorised MITSUBISHI MOTORS dealer.

In such situations, a malfunctioning of the system may be preventing the monitoring of the tyre pressure. Avoid sudden braking, sharp turning and high-speed driving.

- If a malfunction is detected in the tyre pressure monitoring system (TPMS), the warning lamp will blink for approximately 1 minute and then remain continuously illuminated. The warning lamp will issue further warnings each time the engine is restarted as long as the malfunction exists.

Check to see whether the warning lamp goes off after few minutes driving.

If it then goes off during driving, there is no problem.

However, if the warning lamp does not go off, or if it blinks again when the engine is restarted, have the vehicle inspected by an authorised MITSUBISHI MOTORS dealer.

In such situations, a malfunctioning of the system may be preventing the monitoring of the tyre pressure. For safety reasons, when the warning lamp appears while driving, avoid sudden braking, sharp turning and high-speed driving.

📖 NOTE

- The tyre pressure monitoring system does not monitor the spare tyre in the trunk room, even if the inflation pressure sensor is equipped.

Each tyre, including the spare, should be checked monthly when cold and inflated to the inflation pressure recommended by the vehicle manufacturer on the tyre inflation pressure label. (If your vehicle has tyres of a different size than the size indicated on the tyre inflation pressure label, you should determine the proper tyre inflation pressure for those tyres.)

As an added safety feature, your vehicle has been equipped with the tyre pressure monitoring system (TPMS) that illuminates a low tyre pressure telltale when one or more of your tyres is significantly under-inflated.

Accordingly, when the low tyre pressure telltale illuminates, you should stop and check your tyres as soon as possible, and inflate them to the proper pressure. Driving on a significantly under-inflated tyre causes the tyre to overheat and can lead to tyre failure.

Under-inflation also reduces fuel efficiency and tyre tread life, and may affect the vehicle’s handling and stopping ability.

Please note that the tyre pressure monitoring system (TPMS) is not a substitute for proper tyre maintenance, and it is the driver’s

responsibility to maintain correct tyre pressure, even if under-inflation has not reached the level to trigger illumination of the tyre pressure monitoring system (TPMS) low tyre pressure telltale.

Your vehicle has also been equipped with the warning lamp to indicate when the system is not operating properly.

The warning lamp is combined with the low tyre pressure telltale.

When the system detects a malfunction, the telltale will flash for approximately one minute and then remain continuously illuminated. This sequence will continue upon subsequent vehicle start-ups as long as the malfunction exists.

When the warning lamp is illuminated, the system may not be able to detect or signal low tyre pressure as intended.

The tyre pressure monitoring system (TPMS) malfunctions may occur for a variety of reasons, including the installation of replacement or alternate tyres or wheels on the vehicle that prevent the tyre pressure monitoring system (TPMS) from functioning properly. Always check the tyre pressure monitoring system (TPMS) malfunction telltale after replacing one or more tyres or wheels on your vehicle to ensure that the replacement or alternate tyres and wheels allow the tyre pressure monitoring system (TPMS) to continue to function properly.

Tyre pressure monitoring system (TPMS)*

If the warning lamp illuminates while driving

E00637300141

1. If the warning lamp illuminates, avoid hard braking, sharp steering maneuvers and high speeds. You should stop and adjust the tyres to the proper inflation pressure as soon as possible. Refer to “Tyres” on page 10-10.

NOTE

- When inspecting or adjusting the tyre pressure, do not apply excessive force to the valve stem to avoid breakage.
- After inspecting or adjusting the tyre pressure, always reinstall the valve cap on the valve stem.
Without the valve cap, dirt or moisture could get into the valve, resulting in damage to the tyre inflation pressure sensor.
- Do not use metal valve caps, which may cause a metal reaction, resulting in corrosion and damage of the tyre inflation pressure sensors.
- Once adjustments have been made, the warning lamp will go off after a few minutes of driving.

2. If the warning lamp remains illuminated after you have been driving for about 10 minutes after you adjust the tyre inflation pressure, one or more of the tyres may have a puncture. Inspect the tyre and if it has a puncture, have it repaired by an authorised MITSUBISHI MOTORS dealer as soon as possible.

WARNING

- **If the warning lamp illuminates while you are driving, avoid hard braking, sharp steering maneuvers and high speeds. Driving with an under-inflated tyre adversely affects vehicle performance and can result in an accident.**

CAUTION

- The warning lamp may not illuminate immediately in the event of a tyre blowout or rapid leak.

NOTE

- To avoid the risk of damage to the tyre inflation pressure sensors, have any punctured tyre repaired by an authorised MITSUBISHI MOTORS dealer. If the tyre repair is not done by an authorised MITSUBISHI MOTORS dealer, damage to the tyre inflation pressure sensor is not covered by your warranty.

NOTE

- Do not use an aerosol puncture-repair spray on any tyre.
Such a spray could damage the tyre inflation pressure sensors.
Have any puncture repaired by an authorised MITSUBISHI MOTORS dealer.

The tyre pressure monitoring system (TPMS) may not work normally in the following circumstances:

6

- A wireless facility or device using the same frequency is near the vehicle.
- Snow or ice is stuck inside the fenders and/or on the wheels.
- The tyre inflation pressure sensor's battery is dead.
- Wheels other than MITSUBISHI MOTORS GENUINE wheels are being used.
- Wheels that are not fitted with tyre inflation pressure sensors are being used.
- Wheels whose ID codes are not memorized by the vehicle are used.
- A window tint that affects the radio wave signals is installed.

Tyre pressure monitoring system (TPMS)*

NOTE

- Tyre inflation pressures vary with the ambient temperature. If the vehicle is subjected to large variations in ambient temperature, the tyre inflation pressures may be underinflated (causing the warning lamp come on) when the ambient temperature is relatively low. If the warning lamp comes on, adjust the tyre inflation pressure.

6

Whenever the tyres and wheels are replaced with new ones

E00637400054

If new wheels with new tyre inflation pressure sensors are installed, their ID codes must be programmed into the tyre pressure monitoring system. Have tyre and wheel replacement performed by an authorised MITSUBISHI MOTORS dealer to avoid the risk of damaging the tyre inflation pressure sensors. If the wheel replacement is not done by an authorised MITSUBISHI MOTORS dealer, it is not covered by your warranty.

CAUTION

- The use of non-genuine wheels will prevent the proper fit of the tyre inflation pressure sensors, resulting air leakage or damage of the sensors.

Reset of low tyre pressure warning threshold

E00637500026

The threshold is set based on the tyre pressure which the reset function is executed by following procedure.

1. Transit the display by multi-information display switch until the tyre pressure monitoring system (TPMS) SET indicator is displayed.
2. Hold down the multi-information display switch for 3 seconds or more. (A beep is heard.)

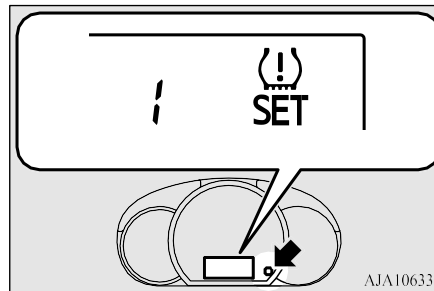

3. The warning lamp start flashing slowly.
4. Drive for a while. The reset is completed if the warning lamp goes out.

NOTE

- The reset function should be executed every time when the tyre pressure is adjusted or tyre rotation.
- The reset function should be executed when the tyre is cold. If it is executed when the tyre is warm (e.g. after driving), there may be the low tyre pressure warning earlier than usual.

Tyre ID set change

E00637600027

In case that 2 sets of tyre inflation pressure sensor ID are registered in the receiver, the valid tyre ID set can be changed by following procedure.

1. Transit the display by multi-information display switch until the tyre pressure monitoring system (TPMS) SET indicator is displayed.
2. Hold down the multi-information display switch for 10 seconds or more. (A beep is heard.)
(Although the reset execution starts at holding down the switch for 3 seconds, keep holding down the switch continuously.)

Rear-view camera*

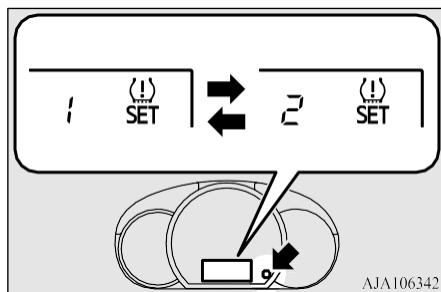

3. The valid tyre ID set is changed, and the number of the tyre pressure monitoring system (TPMS) SET indicator is changed.

NOTE

- Each time this procedure is done, the tyre ID set is changed. (1 - 2 - 1 - 2 ...)
- The tyre ID set is NOT changed, in case that only 1 set of ID is registered.
- When changing the tyre ID set, the reset function of low tyre pressure warning threshold is automatically started. (The warning lamp start flashing slowly.) If the tyre is warm at this time, the reset function should be executed again when the tyre is cold.

Rear-view camera*

E00618402987

The rear-view camera is a system that shows the view behind the vehicle on the screen of the Smartphone-link Display Audio (SDA).

CAUTION

- The rear-view camera is an assistance system that enables the driver to check for obstacles behind the vehicle. Its range of view is limited, so you should not overly depend on it. Please drive just as carefully as you would if the vehicle did not have the rear-view camera.
- Be sure to visually confirm safety around the vehicle with your own eyes. Do not depend entirely on the rear-view camera.

Range of view of rear-view camera

The range of view of the rear-view camera is limited to the area shown in the illustrations. It cannot show the both sides and the lower part of the rear bumper, etc. When reversing, be sure to visually confirm safety around the vehicle.

Location of rear-view camera

The rear-view camera (A) is in the trunk lid.

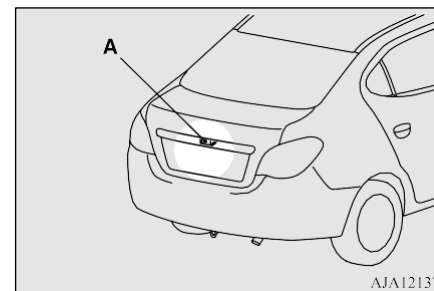

6

Range of view of rear-view camera

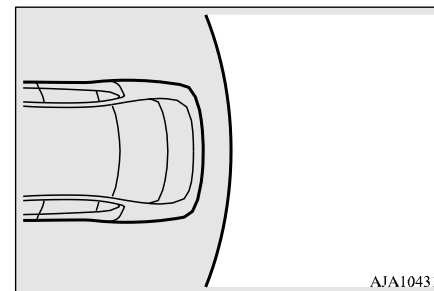

Rear-view camera*

6

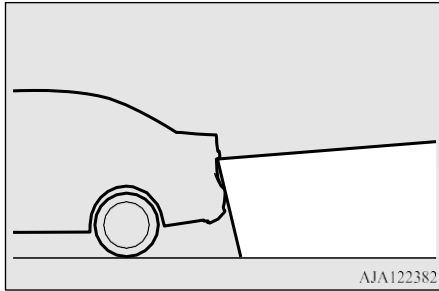

AJA122382

How to use the rear-view camera

When you place the selector lever in the “R” position with the operation mode in ON, the view behind the vehicle will automatically appear on the screen of the Smartphone-link Display Audio (SDA). When you move the selector lever to any other position, the screen will return to its original indication.

CAUTION

- The rear-view camera has a special lens that can make objects shown on the screen appear to be closer or further away than they actually are.

NOTE

- Because the rear-view camera has a special lens, the lines on the ground between parking spaces may not look parallel on the screen.
- In the following situations, the screen indication may be difficult to see. There is no abnormality.
 - Low light (nighttime)
 - When the light of the sun or the light from a vehicle’s headlamps shines directly into the lens
- If the camera is hot and is then cooled by rain or a car wash, the lens can mist up. This phenomenon does not indicate a malfunction.
- It is not possible to fully see obstacles when the lens is dirty. If the lens becomes contaminated by water droplets, snow, mud, or oil, wipe off the contamination, taking care not to scratch the lens.
- Please observe the following cautions. Ignoring them could lead to a camera malfunction.
 - Do not subject the camera to physical shock.
 - Do not apply wax to the camera.
 - Do not splash the camera with boiling water.
 - Do not disassemble the camera.

Reference lines on the screen

Reference lines and upper surface of the rear bumper (A) are displayed on the screen.

- Red line (B) indicates approximately 50 cm behind the rear bumper.
- Green lines (C) indicate approximately 20 cm outside of the vehicle body.
- Short transverse lines (1 to 3) indicate distance from the rear bumper.

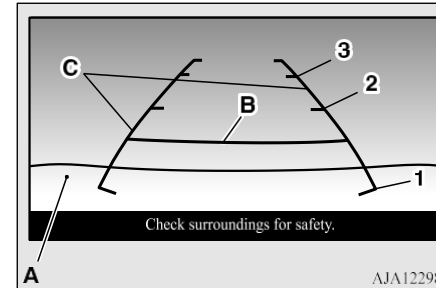

AJA122988

- 1: Approximately at the rear edge of the rear bumper
- 2: Approximately 100 cm
- 3: Approximately 200 cm

NOTE

- When the vehicle is tilting because of the number of people in the vehicle, the weight and positioning of luggage, and/or the condition of the road surface, the lines in the view from the rear-view camera may not be accurately positioned relative to the actual road. The reference lines for distance and vehicle width are based on a level, flat road surface. In the following cases, objects shown on the screen will appear to be farther off than they actually are.
- When the rear of the vehicle is weighed down with the weight of passengers and luggage in the vehicle.

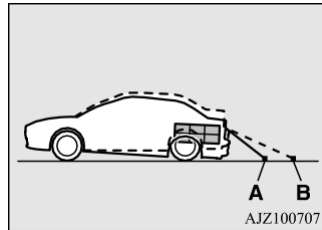

A: Actual objects
B: Objects shown on the screen

NOTE

- When there is an upward slope at the back.

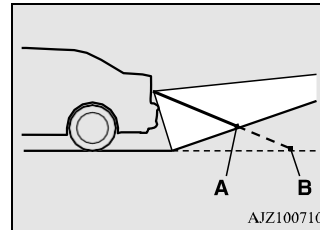

A: Actual objects
B: Objects shown on the screen

NOTE

- The reference lines for distance and vehicle width are intended to indicate the distance to a flat object such as a level, flat road surface. This may make the distance to a projecting object shown on the screen differ from the actual distance to the projecting object. Do not use them as a guide to distances to solid objects.
- Example: On the screen the point (B) appears the nearest, then the point (C) and (A) in order of distance. The point (A) and (B) actually are the same distances from the vehicle, and the point (C) is farther off than the point (A) and (B).

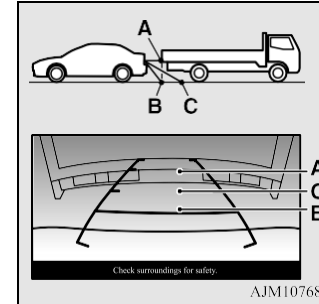

AJM107688

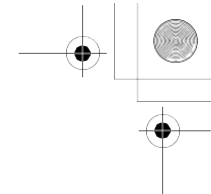
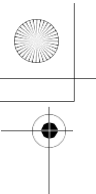

Cargo loads

Cargo loads

E00609902540

Cargo loads precautions

CAUTION

6

- Do not load cargo or luggage higher than the top of the seatback. Be sure that your cargo or luggage cannot move once your vehicle is moving.

Having the rear view blocked, and your cargo being thrown inside the cabin if you suddenly have to brake can cause a serious accident or injury.

- Load heavy cargo or luggage in the front of the vehicle. If the load in the back of the vehicle is too heavy, steering may become unstable.

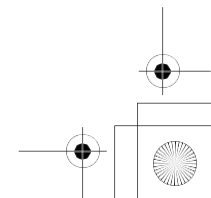
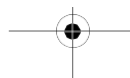
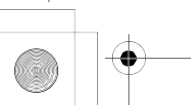
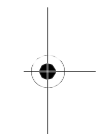

For pleasant driving

Ventilators	7-2
Cooler/Heater/Manual air conditioning*	7-3
Automatic air conditioning*	7-9
Important operation tips for the air conditioning	7-15
Air purifier*	7-15
AM/FM electronic tuning radio with CD player-Type 1*	7-16
AM/FM electronic tuning radio with CD player-Type 2*	7-24
To play tracks from USB device*	7-34
To play tracks from a Bluetooth® device (vehicles with Bluetooth® 2.0 interface).....	7-44
Steering wheel audio remote control switches*	7-46
Error codes.....	7-48
Handling of compact discs	7-50
Antenna	7-51
Link System*	7-51
Bluetooth® 2.0 interface*	7-52
USB input terminal*	7-73
Sun visors	7-76
Ashtray*	7-77
Cigarette lighter*	7-78
Accessory socket*	7-78
Interior lamps	7-79
Storage spaces	7-80
Cup holder	7-80
Bottle holder	7-81
Convenient hook	7-82
Assist grip	7-82

Ventilators

Ventilators

E00700102423

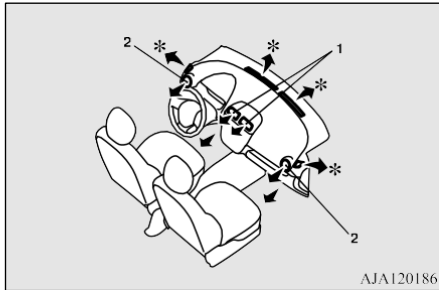

AJA120186

7

*: Optional equipment

1- Centre ventilators

2- Side ventilators

NOTE

- Do not place beverages on top of the instrument panel. If they splash into the air conditioning ventilators, they could damage the system.

Air flow and direction adjustments

E00700201023

Centre ventilators

Move the knob (A) to make adjustments.

7-2 For pleasant driving

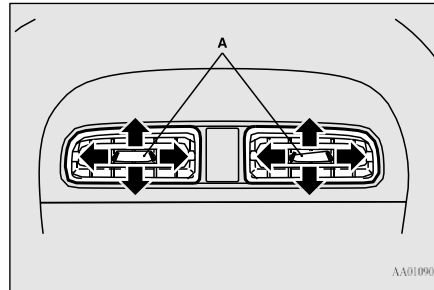

AA0109057

Side ventilators

When the dimple (A) is pressed, the ventilators open.

To close the ventilators, press the dimple on the opposite side.

Change the direction of the air flow by turning the ventilator itself.

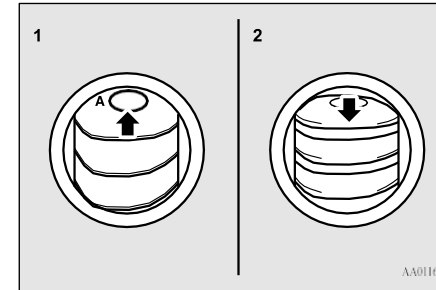

AA0116873

1- Open

2- Close

NOTE

- On vehicles with cooler or air conditioning, the cool air from the ventilators may appear as a mist. This is due to moist air being suddenly cooled by the air conditioning. This will clear after a few moments.

Mode selection

E00726501952

To change the position and amount of air flowing from the ventilators, turn the mode selection dial.

On vehicles with the automatic air conditioning, press the MODE switch or demister switch. (Refer to "MODE switch" on page 7-13, "Demister switch" on page 7-13.)

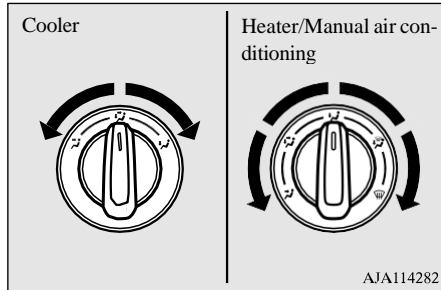

Face position

Air flows only to the upper part of the passenger compartment.

Foot/Face position

Air flows to the upper part of the passenger compartment, and flows to the leg area.

Foot position

Air flows mainly to the leg area.

Foot/Demister position*

Air flows to the leg area, the windscreen and the door windows.

Demister position*

Air flows mainly to the windscreen and the door windows.

CAUTION

- On vehicles with the heater or the manual air conditioning, when using the mode selection dial between the and positions, prevent fogging by moving the air selection lever to select outside air. (Refer to “Air selection lever” on page 7-5.)

NOTE

- For vehicles with the Auto Stop & Go (AS&G) system, the windows may start to fog up during the Auto Stop & Go (AS&G) system is operating. If this occurs, press the demister switch to remove fog from the windows.
- With the mode selection dial between the and positions, air flows mainly to the upper part of the passenger compartment. With the mode selection dial between the and positions, air flows mainly to the leg area.
- With the mode selection dial in the position, a small amount of air flows to the windscreen and the door windows.

Cooler/Heater/Manual air conditioning*

NOTE

- With the mode selection dial between the and positions, air flows mainly to the leg area. With the mode selection dial between the and positions, air flows mainly to the windscreen and door windows (except for vehicles with cooler).

Cooler/Heater/Manual air conditioning*

E00700501765

7

The cooler/heater/air conditioning can only be used while the engine is running.

CAUTION

- The engine speed may increase when the air conditioning is operating. With an increased engine speed, a CVT vehicle will creep to a greater degree than with a lower engine speed. Fully depress the brake pedal to prevent the vehicle from creeping.

Cooler/Heater/Manual air conditioning*

Control panel

E00700601838

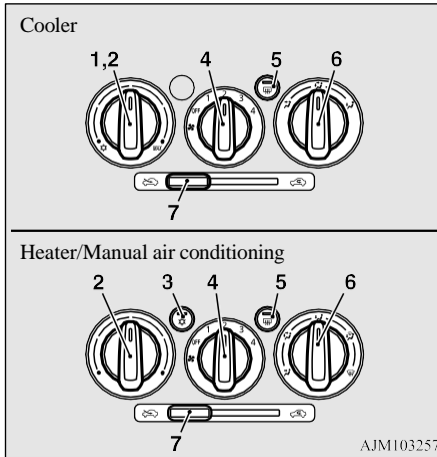

7

- 1- Cooler switch
- 2- Temperature control dial
- 3- Air conditioning switch*
- 4- Blower speed selection dial
- 5- Rear window demister switch
→ P.5-28
- 6- Mode selection dial
- 7- Air selection lever

Blower speed selection dial

E00700701347

Select the blower speed by turning the blower speed selection dial clockwise or anticlockwise. The blower speed will gradually increase as the dial is turned to the right.

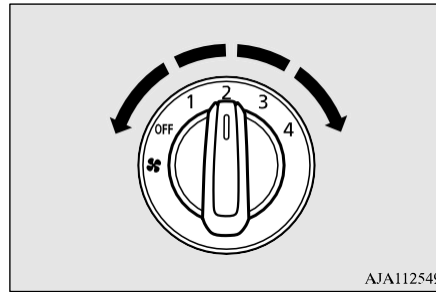

AJA112549

Temperature control dial/cooler switch

E00700901860

The temperature control dial is used to select the desired air temperature. On vehicles with cooler, when the dial is turned clockwise from “●” position at “☼” side, the cooler automatically turns on.

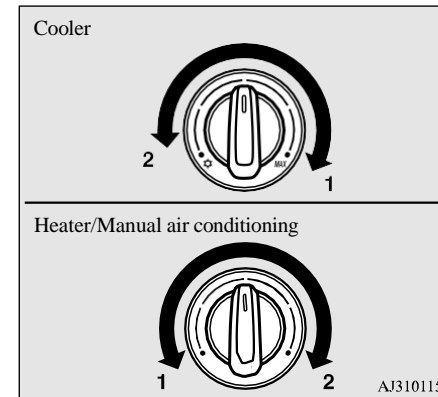

- 1- Cooler
- 2- Warmer

7-4 For pleasant driving



NOTE

- While the engine coolant temperature is low, the temperature of the air from the heater will be cool/cold until the engine warms up, even if you have selected warm air with the dial (except for vehicles with cooler).

Air selection lever

E00701301845

To change the air selection, use the air selection lever.

- “” Outside air
Outside air is introduced into the passenger compartment.
- “” Recirculated air
Air is recirculated inside the passenger compartment.

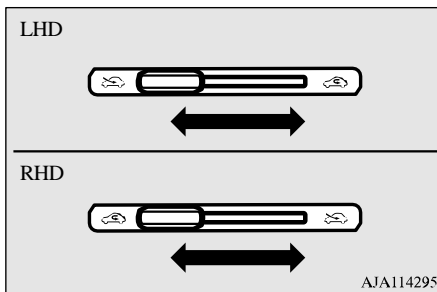

CAUTION

- Use of the recirculation position for an extended time may cause the windows to fog up.

NOTE

- Normally, use the outside position to keep the windscreen and side windows clear and quickly remove fog or frost from the windscreen. If high cooling performance is desired, or if the outside air is dusty or otherwise contaminated use the recirculation position. Switch to the outside position periodically to increase ventilation so that the windows do not become fogged up.

Cooler/Heater/Manual air conditioning*

Air conditioning switch*

E00701502176

Push the switch to turn the air conditioning on, indicator lamp (A) will come on.

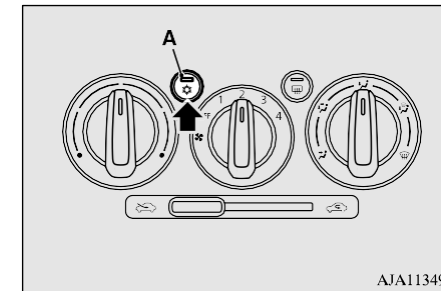

Push the switch again to switch it off.

Operating the air conditioning system

E00701801752

Select dials and lever as shown in the illustration according to your purpose.

Cooler/Heater/Manual air conditioning*

Heating (Heater/Manual air conditioning)

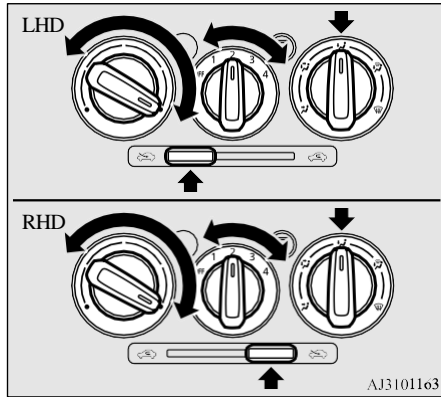

7

NOTE

- For maximum heat, set the blower speed at the 3rd position.

Cooling (Cooler/Manual air conditioning)

E00701902125

Cooler

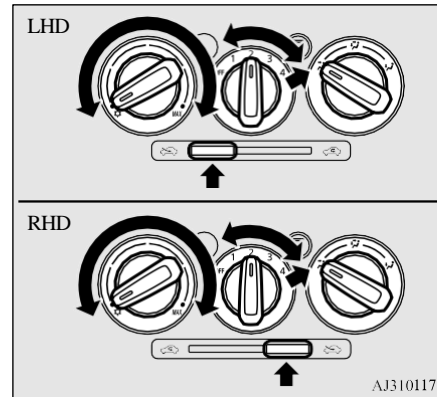

Manual air conditioning

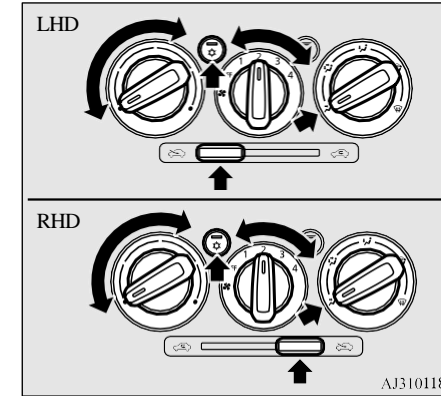

CAUTION

- If the outside air is dusty or otherwise contaminated, or if high cooling performance is desired, set air selection lever to the recirculation position and the temperature control dial to the maximum cool position. Switch to the outside position periodically to increase ventilation so that the windows do not become fogged up.

Combination of unheated air and heated air (Heater/Manual air conditioning)

E00702001621

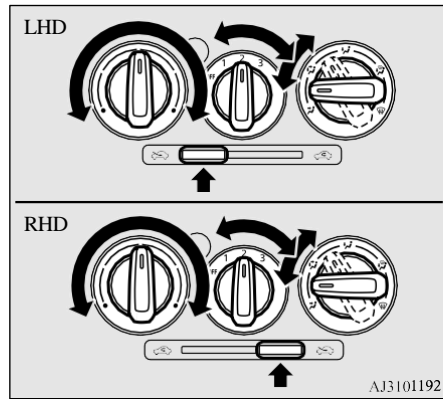

Demisting of the windscreen and door windows (Heater/Manual air conditioning)

E00702102023

CAUTION

- For safety, make sure you have a clear view through all windows.

Cooler/Heater/Manual air conditioning*

For ordinary demisting

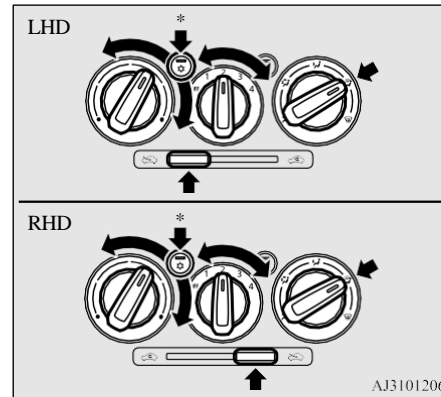

*: Optional equipment

For quick demisting

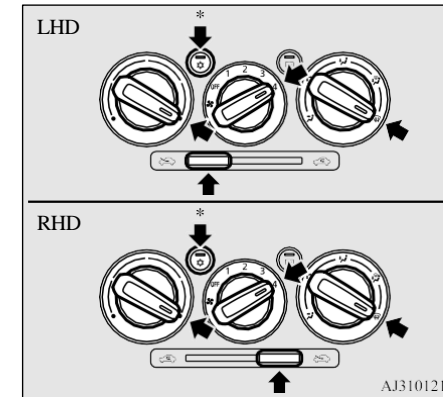

*: Optional equipment

NOTE

- To demist effectively, direct the air flow from the side ventilators towards the door windows.
- Do not set the temperature control dial to the max. cool position. Cool air will blow against the window glasses and prevent demisting.

Cooler/Heater/Manual air conditioning*

Introduction of outside air

E00702201577

Cooler

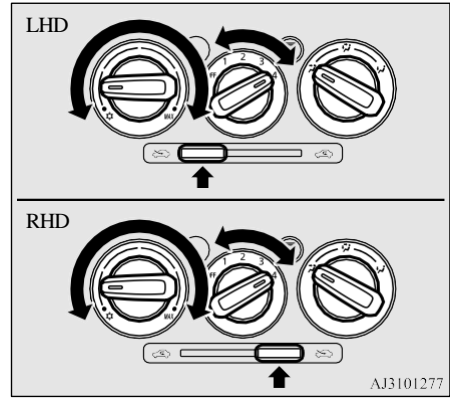

7

Heater/Manual air conditioning

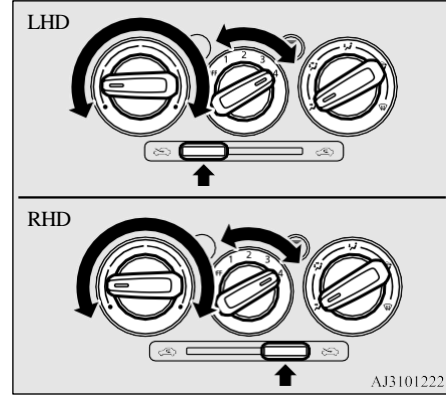

7-8 For pleasant driving

Automatic air conditioning*

Automatic air conditioning*

E00702401768

The air conditioning can only be used while the engine is running.

⚠ CAUTION

- The engine speed may increase when the air conditioning is operating.
With an increased engine speed, a CVT vehicle will creep to a greater degree than with a lower engine speed. Fully depress the brake pedal to prevent the vehicle from creeping.

Control panel

7

E00702502519

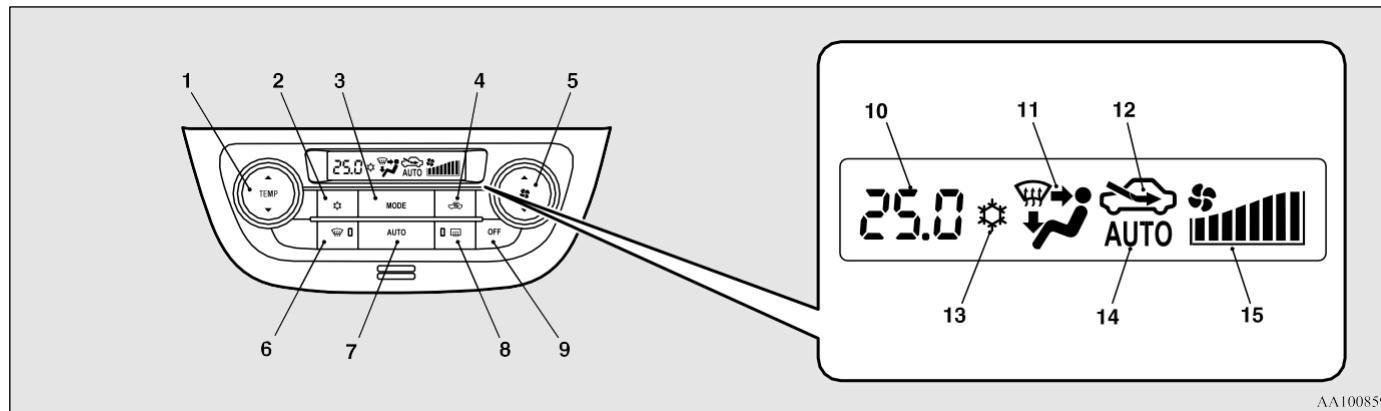

AA1008593

- 1- Temperature control switch
- 2- Air conditioning switch
- 3- MODE switch

- 4- Air selection switch
- 5- Blower speed selection switch
- 6- Demister switch

- 7- AUTO switch
- 8- Rear window demister switch → P.5-28
- 9- OFF switch

For pleasant driving 7-9

Automatic air conditioning*

- 10- Temperature display
- 11- Mode selection display
- 12- Air selection indicator
- 13- Air conditioning indicator
- 14- AUTO indicator
- 15- Blower speed display

NOTE

- There is an interior air temperature sensor (A) in the illustrated position. Never place anything on top of the sensor, since doing so will prevent it from functioning properly.

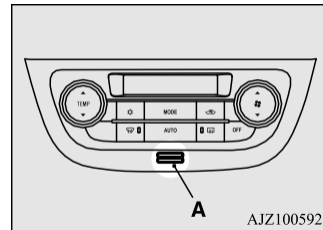

- A sound will be made every time you push all the switches.

Blower speed selection switch

E00702800358

Press ▲ of the blower speed selection switch to increase the blower speed.

Press ▼ of the blower speed selection switch to decrease the blower speed.

7-10 For pleasant driving

The selected blower speed will be shown in the display (A).

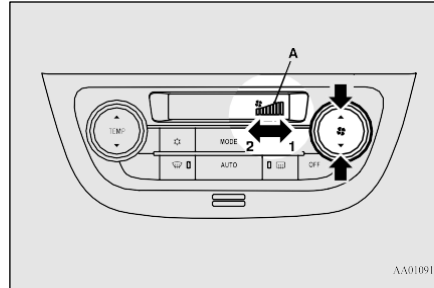

- 1- Increase
- 2- Decrease

Temperature control switch

E00703001820

Press ▲ or ▼ of the temperature control switch to the desired temperature. The selected temperature will be shown in the display (A).

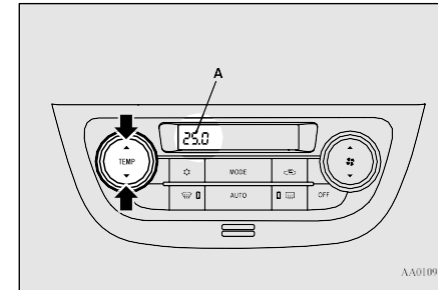

NOTE

- The temperature value of air conditioning is switched in conjunction with outside temperature display unit of the multi information display. Refer to “Changing the temperature unit” on page 5-10.
- While the engine coolant temperature is low, the temperature of the air from the heater will be cool/cold until the engine warms up, even if you have selected warm air with the switch. To prevent the windscreen and windows from fogging up, the ventilator mode will be changed to “” and the blower speed will be reduced.
- When the temperature is set to the highest or the lowest, the air selection and the air conditioning will be automatically changed as follows.

Automatic air conditioning*

NOTE

- Quick Heating (When the temperature is set to the highest setting)
Outside air will be introduced and the air conditioning will stop.
- Quick Cooling (When the temperature is set to the lowest setting)
Inside air will be recirculated and the air conditioning will operate.

The settings described above are the factory settings.

The air selection and air conditioning switches can be customised (function setting changed), and the automatic switching of outside air and the air conditioning according to operating conditions can be changed as desired.



For further information, please consult an authorised MITSUBISHI MOTORS dealer. Refer to “Customising the air conditioning switch” on page 7-12. Refer to “Customising the air selection” on page 7-11.

Air selection switch

E00703401811

To change the air selection, simply press the air selection switch.

The selected position will be shown in the display (A).

- Outside air: “” indicator is ON
Outside air is introduced into the passenger compartment.
- Recirculated air: “” indicator is ON
Air is recirculated inside the passenger compartment.

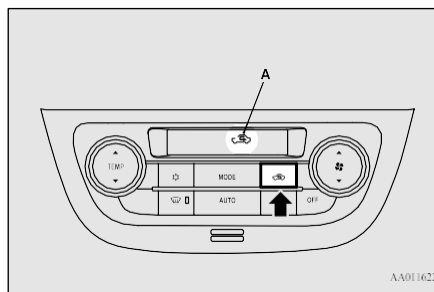
**CAUTION**

- Use of the recirculation position for extended time may cause the windows to fog up.

NOTE

- Normally, use the outside position to keep the windscreen and side windows clear and quickly remove fog or frost from the windscreen.
If high cooling performance is desired, or if the outside air is dusty or otherwise contaminated use the recirculation position.
Switch to the outside position periodically to increase ventilation so that the windows do not become fogged up.
- If you press the AUTO switch to select automatic control after manually switching between outside air and recirculated air, the air selection will also be automatically controlled.

7**■ Customising the air selection**

Functions can be changed as desired, as stated below.

- Enable automatic air control
When the AUTO switch is pressed, the air selection switch is also controlled automatically.
- Disable automatic air control
Even when the AUTO switch is pressed, the air selection switch is not controlled automatically.
- Setting change method

For pleasant driving 7-11

Automatic air conditioning*

Hold down the air selection switch for about 10 seconds or more.

- When the setting is changed from enable to disable 3 sounds are emitted and the “☁” indicator flashes 3 times.
- When the setting is changed from disable to enable 2 sounds are emitted and the “☁” indicator flashes 3 times.

7

NOTE

- The factory setting is “Enable automatic air control”.
- When the demister switch is pressed, in order to prevent misting of the windows the ventilator automatically switches to outside air even if “Disable automatic air control” is set.

AUTO switch

E00702600040

When the AUTO switch is pressed, the mode selection, blower speed adjustment, recirculated/outside air selection, temperature adjustment, and air conditioner ON/OFF status are all controlled automatically.

The “AUTO” indicator will be shown in the display (A).

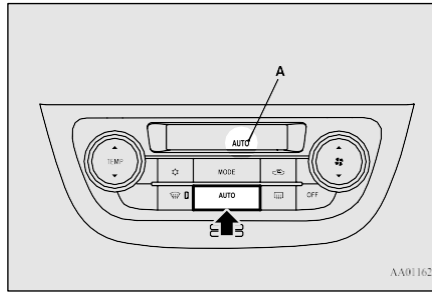

AA0116293

Air conditioning switch

E00703502688

Push the switch to turn the air conditioning on, the “☀” indicator will be shown in the display (A).

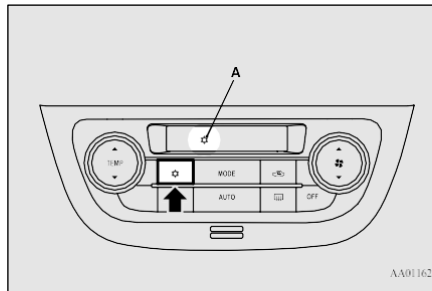

AA0116235

Push the switch again to switch it off.

Customising the air conditioning switch

Functions can be changed as desired, as stated below.

- **Enable automatic air conditioning control:**
When the AUTO switch is pressed, or the temperature control switch is set to the minimum temperature, the air conditioning switch is controlled automatically.
- **Disable automatic air conditioning control:**
The air conditioning switch is not controlled automatically as long as the air conditioning switch is not operated.
- **Setting change method**
Hold down the air conditioning switch for about 10 seconds or more.
 - When the setting is changed from enable to disable
3 sounds are emitted and the “☀” indicator flashes 3 times.
 - When the setting is changed from disable to enable
2 sounds are emitted and the “☀” indicator flashes 3 times.

NOTE

- The factory setting is “Enable automatic air conditioning control”.

Automatic air conditioning*

NOTE

- When the demister switch is pressed, in order to prevent misting of the windows the air conditioning operates automatically even if “Disable automatic air conditioning control” is set.

OFF switch

E0070270004

Push the switch to turn off the air conditioning system.

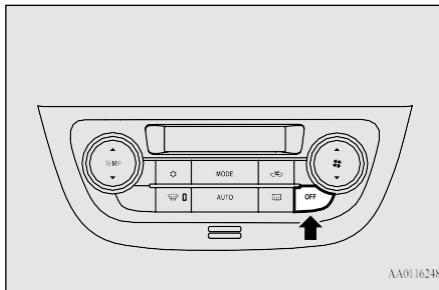

AA0116248

MODE switch

E00703300044

Each time the MODE switch is pressed, the mode changes to the next one in the following sequence: “” → “” → “” → “” → “”. The selected mode is shown in the display (A). (Refer to “Mode selection”

on page 7-2.)

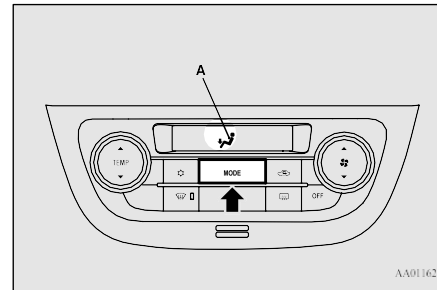

AA0116219

Demister switch

E00703900066

When this switch is pressed, the mode changes to the “” mode. The indicator lamp (A) will come on. The selected mode is shown in the display (B). (Refer to “Mode selection” on page 7-2.)

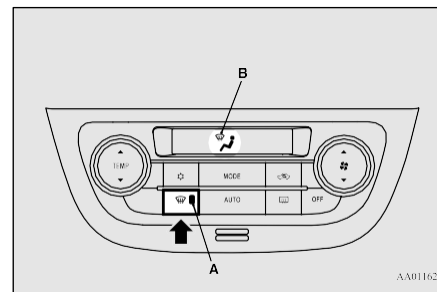

AA0116251

NOTE

- When the demister switch is pressed, the air conditioning system automatically operates and outside air (as opposed to recirculated air) is selected. (Refer to “Demisting of the windscreen and door windows” on page 7-14.)

Operating the system in automatic mode

E00704102652

7

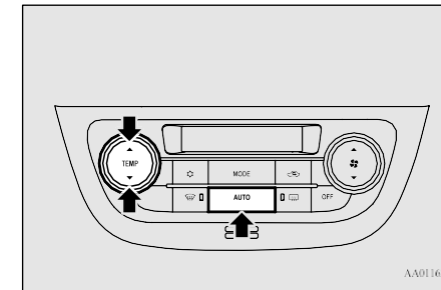

AA0116264

In normal conditions, use the system in the AUTO mode and follow these procedures:

1. Push the AUTO switch.
2. Set the temperature control switch to the desired temperature.

Automatic air conditioning*

The mode selection, blower speed adjustment, recirculated/outside air selection, temperature adjustment, and air conditioner ON/OFF status are all controlled automatically.

NOTE

- If the blower speed selection switch, air conditioning switch, MODE switch, or air selection switch is operated while the system is operating in the AUTO mode, the activated function overrides the corresponding function of automatic control. All other functions remain under automatic control.

7

Operating the system in manual mode

E00704201311

Blower speed and ventilator mode will be controlled manually by setting the blower speed selection switch and the MODE switch to the desired positions.

To return to automatic operation, press the AUTO switch.

Demisting of the windscreen and door windows

E00704300894

CAUTION

- For safety, make sure you have a clear view through all the windows.

For ordinary demisting

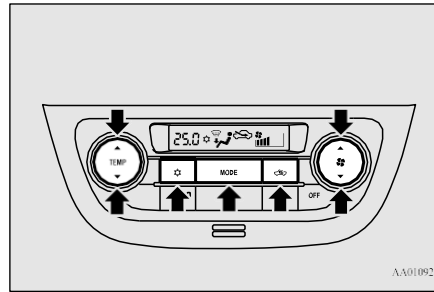

AA0109259

1. Set the air selection switch to the outside position.
2. Set the MODE switch to the “” position.
3. Select your desired blower speed by pressing the blower speed selection switch.
4. Select your desired temperature by pressing the temperature control switch.
5. Push the air conditioning switch.

For quick demisting

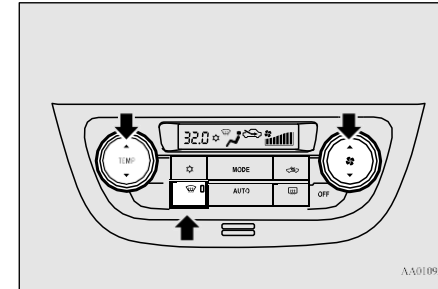

AA0109262

1. Push the demister switch to change to the “” position.
2. Set the blower to the maximum speed.
3. Set the temperature to the highest position.

NOTE

- To demist effectively, direct the air flow from the side ventilators towards the door windows.
- Do not set the temperature to the max. cool position. Cool air will blow against the window glasses and prevent demisting.

Important operation tips for the air conditioning

E00708302900

CAUTION

- The engine speed may increase when the air conditioning is operating. With an increased engine speed, a CVT vehicle will creep to a greater degree than with a lower engine speed. Fully depress the brake pedal to prevent the vehicle from creeping.

- Park the vehicle in the shade.

Parking in the hot sun will make the vehicle inside extremely hot, and it will require more time to cool the interior.

If it is necessary to park in the sun, open the windows for the first few minutes of air conditioning operation to expel the hot air.

- Close the windows when the air conditioning is in use. The entry of outside air through open windows will reduce the cooling efficiency.
- Too much cooling is not good for the health. The inside air temperature should only be 5 to 6 °C below the outside air temperature.

- When operating the system, make sure the air intake, which is located in front of the windscreen, is free of obstructions such as leaves and snow. Leaves collected in the air-intake plenum may reduce air flow and plug the plenum water drains.

Air conditioning system refrigerant and lubricant recommendations

If the air conditioning seems less effective than usual, the cause might be a refrigerant leak. Have the system inspected by your authorised MITSUBISHI MOTORS dealer. The air conditioning system in your vehicle must be charged with the refrigerant HFC-134a and the lubricant DH-PR. Use of any other refrigerant or lubricant will cause severe damage which will result in the need to replace your vehicle's entire air conditioning system. The release of refrigerant into the atmosphere should be prevented. It is recommended that the refrigerant be recovered and recycled for further use.

During a long period of disuse

The air conditioning should be operated for at least five minutes each week, even in cold

Important operation tips for the air conditioning

weather. This is to prevent the compressor from seizing and to maintain the air conditioning in the best operating condition.

Air purifier*

E00708400705

An air filter has been incorporated into this air conditioning so that dirt and dust are cleaned from the air.

Replace the air filter periodically as its ability to clean the air will be reduced as it collects pollen and dirt. For the maintenance interval, refer to the "SERVICE BOOKLET".

7

NOTE

- Operation in certain conditions such as driving on a dusty road and frequent use of the air conditioning can lead to reduction of service life of the filter. When you feel that the airflow is lower than normal or when the windscreen or windows start to fog up easily, replace the air filter. Contact an authorised MITSUBISHI MOTORS dealer for assistance.

AM/FM electronic tuning radio with CD player-Type 1*

AM/FM electronic tuning radio with CD player-Type 1*

E00708503592

The audio system can only be used when the ignition switch or the operation mode is in ON or ACC.

7

NOTE

- To listen to the audio system while the engine is not running, turn the ignition switch to the “ACC” position or put the operation mode in ACC.
For vehicles equipped with the keyless operation system, if the operation mode is left in ACC, the accessory power will automatically turn off after a certain period of time and you will no longer be able to use the audio system. The accessory power comes on again if the engine switch is operated with it in the “ACC” position.
Refer to “ACC power auto-cutout function” on 6-13.
- If a cellular phone is used inside the vehicle, it may create noise from the audio equipment. This does not mean that anything is wrong with your audio equipment. In such a case, use the cellular phone at a place as far away as possible from the audio equipment.

NOTE

- If foreign objects or water get into the audio equipment, or if smoke or a strange odour comes from it, immediately turn off the audio system and have it checked at an authorised MITSUBISHI MOTORS dealer. Never try to repair it by yourself. Avoid continuous usage without inspection by a qualified person.

Volume and tone control panel

E00708601166

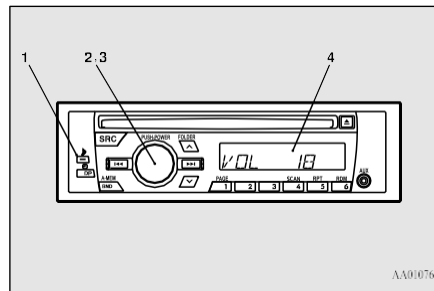

AA0107633

- 1- (Mode change) button
- 2- POWER (On-Off) switch
- 3- Volume control knob/Sound control knob
- 4- Display

To adjust the volume

E00708700681

VOL (Volume control)

Turn the volume control knob clockwise to increase the volume; anticlockwise to decrease the volume.

To adjust the tone

E00708801298

Press the button to select: BASS → TREBLE → FADER → BALANCE → Sound control mode off.

BASS (Bass tone control)

Turn the sound control knob to select the desired bass level.

TREBLE (Treble tone control)

Turn the sound control knob to select the desired treble level.

AM/FM electronic tuning radio with CD player-Type 1*

FADER (Front/Rear balance control)

Turn the sound control knob to balance the volume of sound from the front and the rear speakers.

BALANCE (Left/Right balance control)

Turn the sound control knob to balance the volume of sound from the left and the right speakers.

NOTE

- The sound control mode will be cancelled when the another mode is selected or no adjustment is performed for more than 5 seconds.
- In a two-speakers vehicle, keep the FADER setting in the middle position. Since no rear speakers are connected, adjusting the FADER setting toward the “R” side will result in a loss of sound output.

Radio control panel and display

E00708901244

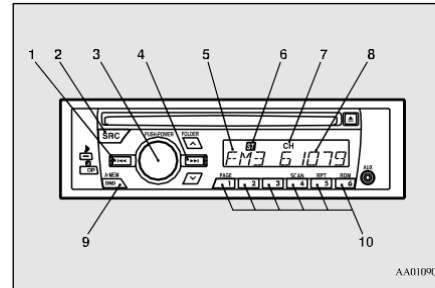

- 1- Seek (Down-seek) button
- 2- SRC (Source changeover) button
- 3- POWER (On-Off) switch
- 4- Seek (Up-seek) button
- 5- AM/FM indicator
- 6- ST (Stereo) indicator
- 7- Preset memory number display
- 8- Frequency display window
- 9- BND (AM/FM1/FM2/FM3 selection)/A-MEM (Auto preset memory) button
- 10- Memory select buttons

To listen to the radio

E00709000913

1. Press the POWER switch to turn the audio system on and off. The system turns on in the last mode used.

2. Press the SRC button several times to select the radio mode.
3. Press the BND button to select the desired band.
4. Press the seek button to tune to a station, or press one of the memory select buttons to recall a station memorised for that button.

To tune the radio

E00709100653

7

Manual tuning

The frequency changes every time the seek button is pressed. Press the button to select the desired station.

Automatic tuning

After keeping the seek button depressed, release the button, and the selected station reception will start.

To enter frequencies into the memory

E00716101199

Manual setting

You can assign to the memory select buttons of 6 stations in the AM band and a maximum of 18 stations in the FM band (6 FM1, 6 FM2

For pleasant driving 7-17

AM/FM electronic tuning radio with CD player-Type 1*

and 6 FM3 stations). (Stations already assigned to the memory select buttons are replaced by any newly assigned stations.)

Follow the steps described below.

1. Press either the seek button to tune the frequency to be entered in the memory.
2. Press one of the memory select buttons for 2 seconds or longer.
The number of the button corresponding to the entry in the memory and the frequency are displayed.
3. The preset memory setting is retrieved by pressing the button and then releasing it within 2 seconds.

7

Automatic setting

With the method, all manually set stations in the band currently selected for reception are replaced with stations in the same band that are automatically selected in order of signal strength.

The radio automatically selects 6 stations each in the AM or FM band.

Follow the steps described below.

1. Press the BND button to select the desired band.

7-18 For pleasant driving

2. Hold down the BND button for 2 seconds or longer. The 6 stations with best signal strength will automatically be assigned to the memory select buttons, with the lowest-frequency station being assigned to the lowest-number button. The radio will begin receiving the station stored on “CH 1”.
3. When you subsequently press a memory select button to select a channel number, the radio will begin receiving the station assigned to that number.

CD control panel and display

E00709501221

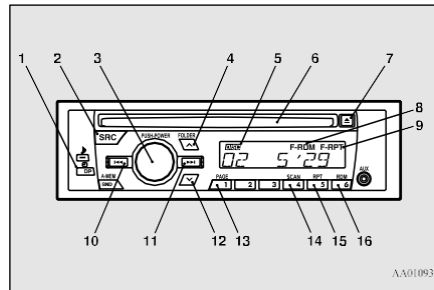

AA0109392

- 1- DP (Title display) button
- 2- SRC (Source changeover) button
- 3- POWER (On-Off) switch
- 4- FOLDER (Folder up) button
- 5- DISC (CD mode) indicator
- 6- Disc-loading slot

- 7- CD eject button
- 8- RDM/F-RDM indicator
- 9- RPT/F-RPT indicator
- 10- ◀◀ (Fast-reverse/Track down) button
- 11- ▶▶ (Fast-forward/Track up) button
- 12- FOLDER (Folder down) button
- 13- PAGE (Title scroll) button
- 14- SCAN button
- 15- RPT (Repeat) button
- 16- RDM (Random) button

To listen to a CD

E00709602317

To set a disc

1. Insert a disc with the label facing up, and the CD player will begin playing even if the another mode is being used. The DISC indicator, the track number, the playing time will appear on the display.
2. When the CD mode is selected by pressing the SRC button several times with the disc in the player, the CD player will start playback.
3. To stop the CD, turn off the power by pressing the POWER switch or change over to the another mode by pressing the SRC button, or eject the disc by pressing the eject button.

AM/FM electronic tuning radio with CD player-Type 1*

 **NOTE**

- To adjust the volume and tone, refer to “To adjust the volume” on page 7-16 and “To adjust the tone” on page 7-16.
- 8 cm compact disc cannot be played on this CD player.
- For information concerning the handling of compact discs, refer to “Handling of compact discs” on page 7-50.

To eject a disc

When the CD eject button is pressed, the disc automatically stops and is ejected.

 **NOTE**

- If you do not remove the disc before 15 seconds have elapsed, the CD player will automatically reload the disc and stop.

To listen to a music CD

Press the SRC button several times if a disc is already in the CD player. The audio system will enter CD mode and start playback. The track number and the playing time will appear on the display. The tracks in the disc will be played continuously.

To listen an MP3 CD

This CD player allows you to play MP3 (MPEG Audio Layer-3) files recorded on CD-ROMs, CD-Rs (recordable CDs), and CD-RWs (rewritable CDs) in ISO9660 Level 1/Level 2, Joliet, and Romeo formats. Each disc may have a maximum of 16 trees, 255 folders, and 511 files per disc. During MP3 playback, the unit can display ID3 tag information. For information concerning ID3 tag, refer to “CD text and MP3 title display” on page 7-21.

1. Insert a disc containing MP3 files into the slot.
Press the SRC button if a disc is already in the CD player.
2. The display shows the folder number and the file number, then playback will begin.

 **NOTE**

- With a disc that contains both CD-DA (CD-Digital Audio) and MP3 files, the CD-DA are automatically played first.
- The playback sound quality differs depending on the encoding software and the bit rate. For details, refer to the user manual of your encoding software.
- Depending on file/folder configurations on a disc, it may take some time before playback starts.

 **NOTE**

- MP3 encode software and writing software are not supplied to this unit.
- You may encounter trouble in playing an MP3 or displaying the information of MP3 files recorded with certain writing software or CD recorders (CD-R/RW drivers).
- If you record too many folders or files other than MP3 onto a disc, it may take some time before playback starts.
- This unit does not record MP3 files.
- For information concerning CD-Rs/RWs, refer to “Notes on CD-Rs/RWs” on page 7-51.

 **CAUTION**

- Attempting to play a file not in the MP3 format which has the “.mp3” file name may produce noise from the speakers and speaker damage, and can damage your hearing.

AM/FM electronic tuning radio with CD player-Type 1*

Folder selection order/MP3 file playback order (Example)

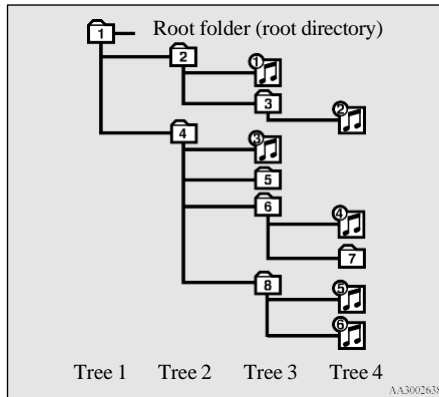

Folder selection

In the order

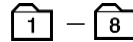

File selection

In the order

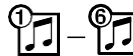

To fast-forward/fast-reverse the disc

Fast-forward

You can fast-forward the disc by pressing the ►► button. While the button is kept pressed, the disc will be fast-forwarded.

7-20 For pleasant driving

Fast-reverse

You can fast-reverse the disc by pressing the ◀◀ button. While the button is kept pressed, the disc will be fast-reversed.

To select a desired folder (MP3 CDs only)

Folder up

Press the FOLDER ^ button until the desired folder number appears on the display.

Folder down

Press the FOLDER v button until the desired folder number appears on the display.

To select a desired track

Track up

Press the ►► button repeatedly until the desired track number appears on the display.

Track down

Press the ◀◀ button repeatedly until the desired track number appears on the display.

NOTE

- Pressing the ◀◀ button once during the song will cause the CD player to restart playback from the beginning of the song.

To repeat a track

Press the RPT button briefly while the track is playing. "RPT" will appear on the display. To exit the repeat mode, press the RPT button.

To repeat a folder (MP3 CDs only)

Press the RPT button for 2 seconds or longer (until you hear a beep). "F-RPT" will appear on the display. You can listen to all the files in the currently selected folder repeatedly.

NOTE

- With a disc that contains both CD-DA and MP3 files, the repeat mode causes only files of the same format (CD-DA only or MP3 files only) to be repeated.

To play tracks in random order

Random playback for a disc (music CDs only)

Press the RDM button briefly. "RDM" will appear on the display. Tracks on the disc will be played in a random sequence.

To exit the random mode, press the RDM button again.

Random playback for a folder (MP3 CDs only)

Press the RDM button briefly. "RDM" will appear on the display. Files on the currently selected folder will be played in a random sequence.

To exit the random mode, press the RDM button again.

Random playback for all folders on a disc (MP3 CDs only)

Press the RDM button for 2 seconds or longer (until you hear a beep). "F-RDM" will appear on the display. Files from all the folders on the disc will be played in a random sequence.

To exit the random mode, briefly press the RDM button again.

NOTE

- With a disc that contains both CD-DA and MP3 files, the random mode causes only files of the same format (CD-DA only or MP3 files only) to be played in a random sequence.

To find the start of each track on a disc for playback

Press the SCAN button. The CD player will play back the first 10 seconds of each track on the disc.

The track number will blink while the scan mode is selected.

To exit this mode, press the SCAN button again.

NOTE

- Once all tracks on the disc have been scanned, playback of the disc will restart from the beginning of the track that was playing when scanning started.
- With a disc that contains both CD-DA and MP3 files, the CD-DA are automatically scanned first.

To find the start of first tracks in all folders for playback (MP3 CDs only)

Press and hold the SCAN button until you hear a beep.

The CD player will play back the first tracks in all folders are played for 10 seconds from the beginning.

The file number will blink while the scan mode is selected.

To exit this mode, press the SCAN button again.

7

NOTE

- Once the cueing playback ends, playback will start from the track at the beginning of the folder next to the one that was playing when the cueing started.

CD text and MP3 title display

E00725000692

This CD player can display CD text and MP3 titles including ID3 tag information.

CD text

Press the DP button repeatedly to make selections in the following sequence: track num-

AM/FM electronic tuning radio with CD player-Type 1*

ber/play time → disc name → track name → clock.

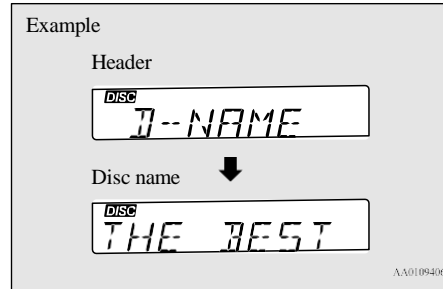

7

NOTE

- The display can show up to 8 characters. If a disc name or track name has more than 8 characters, press the PAGE button to view the next 8 characters.
- When there is no title information to be displayed, the display shows “NO NAME”.
- Characters that the CD player cannot display are shown as “ ”.

MP3 title/ID3 tag information

Press the DP button repeatedly to make selections in the following sequence: folder number/file number → playing time → folder name → file name → album name → title name/artist name → clock.

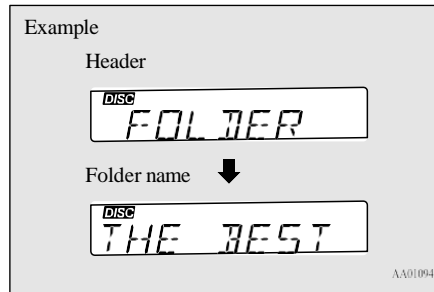

NOTE

- When there is no title information to be displayed, the display shows “NO NAME”.
- The display can show up to 8 characters. If a folder name, file name, or item of ID3 tag information has more than 8 characters, press the PAGE button to view the next 8 characters.
- Characters that the CD player cannot display are shown as “ ”.

To adjust the clock

E00766201049

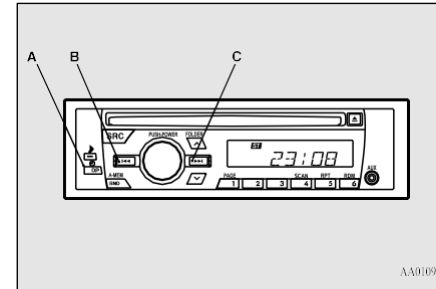

- A- (Clock) button
 B- (clock adjustment down) button
 C- (clock adjustment up) button

1. Press the button several times to switch the clock mode.
2. Press and hold the button for 2 seconds or longer (until you hear a beep) until the clock display flashes.
3. Press the or button to adjust the “hours” digit.
If you keep pressing the button, fast-forward begins.
4. When the “hours” digit is adjusted, press the button to flash the “minutes” digit.
Press the or button to adjust the “minutes” digit.

AM/FM electronic tuning radio with CD player-Type 1*

If you keep pressing the button, fast-forward begins.

- When the time is set, press the  button to stop the clock display from flashing.

NOTE

- Reset the time after the battery terminals are disconnected and reconnected.
- Seconds do not appear in the clock display, but after adjusting the “minutes” setting, the clock begins to operate from 0 seconds.

To use the external audio input function

E00766301040

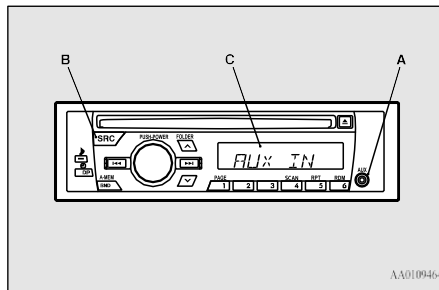

- A- Auxiliary Audio connector (mini-jack)
- B- SRC (Source changeover) button
- C- Display

You can listen to commercially available audio equipment, such as a portable audio system, from your vehicle’s speakers, by connecting the audio equipment to the auxiliary audio connector.

NOTE

- Use a stereo mini-jack connector to connect the audio equipment to the auxiliary audio connector.

To activate the external audio input mode

E00766400031

- Connect the headphone port of the portable audio system to the auxiliary audio connector using a commercially available connection cord.
- Press the SRC button several times to switch to the AUX mode. The display will show “AUX” and then the external audio input mode will be activated.
- To deactivate the external audio input mode, press the SRC button to switch to another mode.

CAUTION

- Do not operate the connected audio equipment while driving. This could distract you and an accident might occur.

NOTE

- The connected audio equipment cannot be operated with the vehicle’s audio system.
- Depending on the connected audio equipment, it may produce noise from the speakers.
- Use the connected audio equipment’s own power source, such as its battery. Noise may be produced from the speakers if the connected audio equipment is used while charging it using the accessory socket of the vehicle.
- Do not activate the external audio input mode when no audio equipment is connected. Otherwise, noise may be produced from the speakers.
- Connect audio equipment when the external audio input mode is deactivated or lower the vehicle’s speaker volume before connecting it. Noise may be produced from the speakers if audio equipment is connected after the external audio input mode is activated.
- Compared to the CD player mode and radio mode, the vehicle’s speaker volume will be lower in the external audio input mode. Therefore, be careful when switching from the external audio input mode to the CD player mode or radio mode since the speaker volume will be higher.
- Do not use excessive force on the connection cord. Otherwise, the cord and connectors may be damaged.

AM/FM electronic tuning radio with CD player-Type 2*

NOTE

- If the connection cord alone is left connected to the auxiliary audio connector, noise may be produced from the speakers.
- For information on how to connect and operate the commercially available audio equipment, refer to the owner's manual for the commercially available audio equipment.

7

AM/FM electronic tuning radio with CD player-Type 2*

E00708503606

The audio system can only be used when the ignition switch or the operation mode is in ON or ACC.

NOTE

- To listen to the audio system while the engine is not running, turn the ignition switch to the "ACC" position or put the operation mode in ACC.
For vehicles equipped with the keyless operation system, if the operation mode is left in ACC, the accessory power will automatically turn off after a certain period of time and you will no longer be able to use the audio system. The accessory power comes on again if the engine switch is operated with it in the "ACC" position.
Refer to "ACC power auto-cutout function" on 6-13.
- If a cellular phone is used inside the vehicle, it may create noise from the audio equipment. This does not mean that anything is wrong with your audio equipment. In such a case, use the cellular phone at a place as far away as possible from the audio equipment.
- If foreign objects or water get into the audio equipment, or if smoke or a strange odour comes from it, immediately turn off the audio system and have it checked at an authorised MITSUBISHI MOTORS dealer. Never try to repair it by yourself. Avoid continuous usage without inspection by a qualified person.

Volume and tone control panel

E00708602192

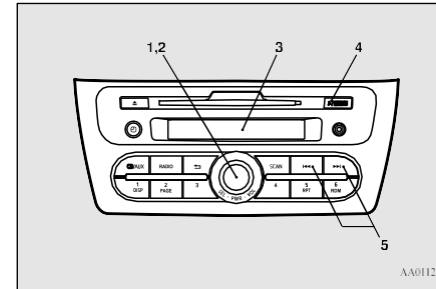

- 1- PWR (On-Off) switch
- 2- VOL (Volume control) knob
- 3- Display
- 4- (Mode change) button (vehicles without Bluetooth® 2.0 interface)/
 /MENU (Mode change) button (vehicles with Bluetooth® 2.0 interface)
- 5- Sound control button

To adjust the volume

E00708700708

Turn the VOL knob clockwise to increase the volume; anticlockwise to decrease the volume.

AM/FM electronic tuning radio with CD player-Type 2*

To adjust the tone

E00708802354

Press the **♪** button or **♪/MENU** button to select **BASS** → **TREBLE** → **FADER** → **BALANCE** → Sound control mode off.

BASS (Bass tone control)

Press the sound control button either **◀◀** or **▶▶** to select the desired bass level.

TREBLE (Treble tone control)

Press the sound control button either **◀◀** or **▶▶** to select the desired treble level.

FADER (Front/Rear balance control)

Press the sound control button either **◀◀** or **▶▶** to balance the volume of sound from the front and the rear speakers.

BALANCE (Left/Right balance control)

Press the sound control button either **◀◀** or **▶▶** to balance the volume of sound from the left and the right speakers.

NOTE

- The sound control mode will be cancelled when the another mode is selected or no adjustment is performed for more than 10 seconds.
- In a two-speakers vehicle, keep the FADER setting in the middle position. Since no rear speakers are connected, adjusting the FADER setting toward the “REAR” side will result in a loss of sound output.

Radio control panel and display

E00708901260

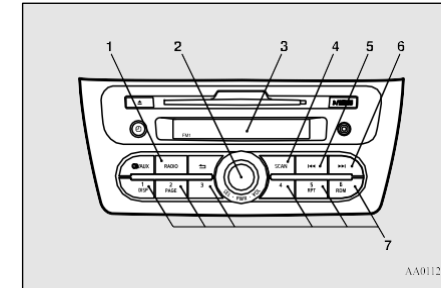

7

- 1- RADIO (AM/FM selection/Auto preset memory) button
- 2- PWR (On-Off) switch
- 3- Display
- 4- SCAN button
- 5- Seek (Down-Seek) button
- 6- Seek (Up-Seek) button
- 7- Memory select buttons

To listen to the radio

E00709000939

1. Press the PWR switch or the RADIO button to turn on the radio.
Press and hold the PWR switch for 2 seconds or longer to turn off the radio.
2. Press the RADIO button to select the desired band.

AM/FM electronic tuning radio with CD player-Type 2*

3. Press the seek button or memory select buttons to tune into a radio broadcasting station.

To tune the radio

E00709100666

Manual tuning

The frequency changes every time the seek button is pressed. Press the button to select the desired radio broadcasting station.

7

Automatic tuning

- After keeping the seek button depressed until it beeps, release the button, and the selected station reception will start.
- Press the SCAN button. The radio will tune consecutively to each available station for about 5 seconds per station. If you want to stop scanning, press the SCAN button again.
The frequency display blinks during SCAN.

To enter frequencies into the memory

E00716102226

Manual setting

You can assign to the memory select buttons a maximum of 6 stations in the FM band and 6 stations in the AM band. (Stations already assigned to the memory select buttons are replaced by any newly assigned stations.)

Follow the steps described below.

1. Press the seek button to tune to the frequency you wish to keep in the memory.
2. Press one of the memory select buttons until it beeps.

- The sound will be momentarily interrupted while the frequency is being entered into the memory. The number of the button matching the entry in the memory as well as the frequency is displayed.
3. The preset memory setting is retrieved by pressing the button and then releasing it within 1 second.

Automatic setting

Besides the manually set stations, as many as 6 AM and 6 FM stations can be automatically entered in the memory.

Follow the steps described below.

1. Press the RADIO button to select the desired band.
2. Hold down the RADIO button for 2 seconds or longer. The 6 stations with best signal strength will automatically be assigned to the memory select buttons, with the lowest-frequency station being assigned to the lowest-number button. The radio will begin receiving the station stored on "ch 1".
3. When you subsequently press a memory select button to select a channel number, the radio will begin receiving the station assigned to that number.

NOTE

- You can switch between the manual setting mode and the automatic setting mode by hold down the RADIO button for 2 seconds or longer.
"AUTO-P" is displayed while the radio is in the automatic setting mode.

AM/FM electronic tuning radio with CD player-Type 2*

CD control panel and display

E00709501247

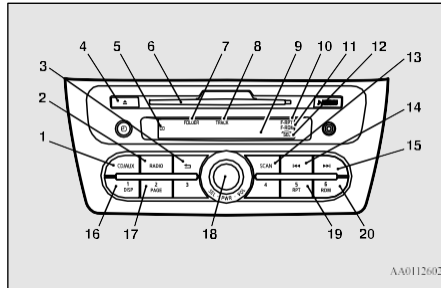

AA0112602

- 1- CD (CD mode changeover) button
- 2- RADIO button
- 3- ⏪ (Return) button
- 4- CD eject button
- 5- CD indicator
- 6- Disc-loading slot
- 7- FOLDER (Folder number) indicator
- 8- TRACK (Track number) indicator
- 9- Display
- 10- RPT (Repeat)/F-RPT (Folder repeat mode) indicator
- 11- RDM (Random mode)/F-RDM (Folder random mode) indicator
- 12- SEL (Select) indicator
- 13- SCAN button
- 14- ⏮ (Fast-reverse/Track down) button
- 15- ⏭ (Fast-forward/Track up) button
- 16- DISP (Display) button
- 17- PAGE (Title scroll) button

- 18- PWR (On-Off)/SEL (Select) switch
- 19- RPT (Repeat) button
- 20- RDM (Random) button

To listen to a CD

E00709602346

To set a disc

1. Insert the disc with the label facing up.
When a disc is inserted, the CD indicator will come on and the CD player will begin playing even if the radio is being used. The CD player will also start playback when the CD button is pressed with a disc in the player or with a disc set in the Disc-loading slot, even if the radio is being used.
2. To stop the CD, turn off the power by pressing the PWR switch for 2 seconds or longer, or change over to the radio mode by pressing the RADIO button, or eject the disc by pressing the eject button.

NOTE

- For information on adjusting the volume and tone, refer to “To adjust the volume” on page 7-24 and “To adjust the tone” on page 7-25.
- 8 cm compact disc cannot be played on this CD player.

NOTE

- For information concerning the handling of compact discs, refer to “Handling of compact discs” on page 7-50.

To eject a disc

When the CD eject button is pressed, the disc automatically stops and is ejected.

NOTE

- If you do not remove the disc before 15 seconds have elapsed, the CD player will automatically reload the disc and stop.

7

To listen to a music CD

Press the CD button if a disc is already in the CD player. The CD player will enter CD mode and start playback. The track number and the playing time will appear on the display. The tracks in the disc will be played continuously.

To listen to an MP3 CD

This CD player allows you to play MP3 (MPEG Audio Layer-3) files recorded on CD-ROMs, CD-Rs (recordable CDs), and

For pleasant driving 7-27

AM/FM electronic tuning radio with CD player-Type 2*

CD-RWs (rewritable CDs) in ISO9660 Level 1/Level 2, Joliet, and Romeo formats. Each disc can hold up to 255 files in up to 100 folders, up to a maximum of 16 levels. The ID3 tag information can be displayed during MP3 playback. For information concerning ID3 tags, refer to “CD text and MP3 title display” on page 7-30.

7

1. Insert a disc containing MP3 files into the slot.
2. Press the CD button if a disc is already in the CD player.
The display shows “READING”, then playback will begin.

NOTE

- While listening to a disc on which CD-DA (CD-Digital Audio) and MP3 files have both been recorded, you can switch between reading of the CD-DA, reading of the MP3 files, and the external audio input mode by pressing the CD button for 2 seconds or longer (until you hear a beep).
For information on the external audio input, refer to “To use the external audio input function” on page 7-33.
- With a disc that contains both CD-DA and MP3 files, the CD-DA files are automatically played first.

NOTE

- The playback sound quality differs depending on the encoder software and the bit rate. For more information, refer to the owner’s manual for the encoder software.
- Depending on the layout of the files and folders on the disc, it may take some time until playback starts.
- MP3 conversion software and writing software are not supplied to this unit.
- You may encounter trouble in playing an MP3 or displaying the information of MP3 files recorded with certain writing software or CD recorders (CD-R/RW drivers).
- If you write many folders or files other than MP3 files, it may take some time until playback starts.
- This unit does not record MP3 files.
- For information on CD-Rs/RWs, refer to “Notes on CD-Rs/RWs” on page 7-51.

CAUTION

- Attempting to play a file not in the MP3 format that has the “.mp3” file extension may produce noise from the speakers and speaker damage, and can significantly damage your hearing.

Folder selection order/MP3 file playback order (Example)

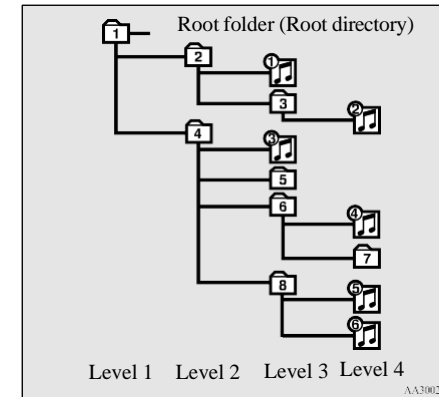

Folder selection
in the order

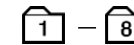

File selection
in the order



To fast-forward/reverse the disc

Fast-forward

The disc is fast-forwarded while the ►►1 button is held down. Playback will begin once the button is released.

AM/FM electronic tuning radio with CD player-Type 2*

Fast-reverse

The disc is fast-reversed while the **1◀◀** button is held down.
Playback will begin once the button is released.

To select a desired track**Track up**

The disc will skip as many songs as the number of times the button **▶▶1** is pressed.
The display window will display the track number of the track selected.

Track down

The disc will skip as many songs as the number of times the button **1◀◀** is pressed.
The display window will display the track number of the track selected.

To find a file (MP3 CDs only)

Operate the SEL switch to select desired file.
When this mode is activated by pressing the SEL switch, the SEL indicator will be displayed in the display.

Press the SEL: To start this mode or to select switch the folder or file.
Turn the SEL : To show the folder or file switch

NOTE

- To cancel the selection, press the **↶** button to return to the previous step.
- If no operation is performed for 10 seconds or more or other button is operated after the SEL switch has been turned, searching of the desired file is cancelled.
- If no operation is performed for 5 seconds or more after the file is displayed, playback starts.
- When the SEL indicator is not shown on the display and the SEL switch is operated, the volume adjustment is effective.

To repeat tracks**To repeat a track**

Press the RPT button to repeat the same track.
If the RPT button is pressed, the RPT indicator will come on.
To exit this mode, press the button again.

To repeat songs in the same folder (MP3 CDs only)

While a song is playing, press the RPT button for 2 seconds or longer (until you hear a beep). The F-RPT indicator will come on and the disc will repeat all the songs in the folder that contains the song currently playing.
To exit this mode, press the button again.

NOTE

- With a disc that contains both CD-DA and MP3 files, the repeat mode causes only files of the same format (CD-DA only or MP3 files only) to be repeated.

To change track playback order**Random playback for a disc (music CDs only)**

If the RDM button is pressed, the RDM indicator will come on and the tracks that are played will be selected at random.
To exit this mode, press the button again.

Random playback for a folder (MP3 CDs only)

If the RDM button is pressed, the F-RDM indicator will come on and the tracks that are

For pleasant driving 7-29

AM/FM electronic tuning radio with CD player-Type 2*

played will be selected at random from the folder that is currently selected.
To exit this mode, press the button again.

Random playback for all folders on a disc (MP3 CDs only)

Press the RDM button for 2 seconds or longer (until you hear a beep). The RDM indicator will come on and the tracks that are played will be selected at random from all folders on the disc currently selected.

7

To exit this mode, press the button again.

NOTE

- With a disc that contains both CD-DA and MP3 files, the random mode causes only files of the same format (CD-DA only or MP3 files only) to be played in a random sequence.

To find the start of each track on a disc for playback

Press the SCAN button. The CD player will play back the first 10 seconds of each track on the disc. The track number will blink while the scan mode is selected.

To exit this mode, press the button again.

7-30 For pleasant driving

NOTE

- Once all tracks on the disc have been scanned, playback of the disc will restart from the beginning of the track that was playing when scanning started.
- The scan mode will be cancelled when radio or CD operation is selected.
- With a disc that contains both CD-DA and MP3 files, the scan mode causes only files of the same format (CD-DA only or MP3 files only) to be played.

CD text and MP3 title display

E00725000706

This CD player can display CD text and MP3 titles, including ID3 tag information.

CD text

The CD player can display disc and track titles for discs with converted disc and track title information. Press the DISP button repeatedly to make selections in the following sequence: disc name → track name → normal display mode.

NOTE

- The display can show up to 11 characters. If a disc name or track name has more than 11 characters, press the PAGE button to view the next 11 characters.

NOTE

- When there is no title information to be displayed, the display shows “NO TITLE”.
- Characters that the CD player cannot display are shown as “•”.

MP3 titles

The CD player can display folder and file titles for discs with converted folder and file information. Press the DISP button repeatedly to make selections in the following sequence: folder name → file name → normal display mode.

ID3 tag information

The CD player can display ID3 tag information for files that have been recorded with ID3 tag information.

1. Press the DISP button for 2 seconds or longer to switch to the ID3 tag information.
2. Press the DISP button repeatedly to make selections in the following sequence: album TAG → track TAG → artist TAG → normal display mode.



AM/FM electronic tuning radio with CD player-Type 2*

NOTE

- To return from ID3 tag information to the folder name, press the DISP button again for 2 seconds or longer.
- When there is no title information to be displayed, the display shows “NO TITLE”.
- The display can show up to 11 characters. If a folder name, track name, or item of ID3 tag information has more than 11 characters, press the PAGE button to view the next 11 characters.
- Characters that the CD player cannot display are shown as “•”.

To display the clock

E00766500029

Press the  button to switch the clock mode.
To exit the clock mode, press the  button.

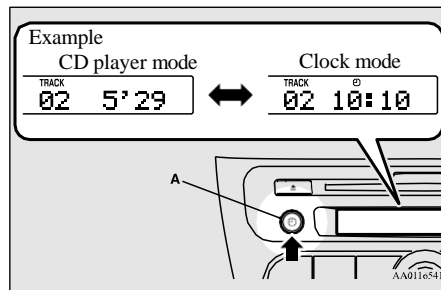

A-  (Clock) button



NOTE

- While the clock mode is selected, the display will switch to the applicable operation display whenever the CD player, external audio input mode or radio, etc. is operated. Then, if no entries are made for 7 seconds, the display will automatically return to the clock mode.

To adjust the clock

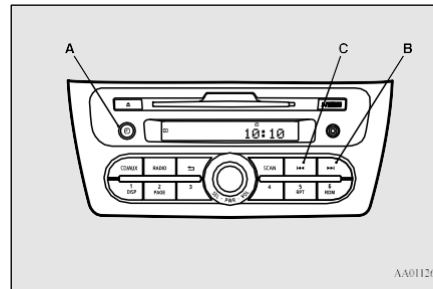





E00766201081



- A-  (Clock) button
B-  button
C-  button









Vehicles without Bluetooth® 2.0 interface

1. Press and hold the  button and the clock display flashes.

2. Press the  or  button to adjust the “hours” digit.
If you keep pressing the button, fast-forward begins.
3. When the “hours” digit is adjusted, press the  button to flash the “minutes” digit.
Press the  or  button to adjust the “minutes” digit.
If you keep pressing the button, fast-forward begins.
4. When the time is set, press the  button to stop the clock display from flashing.

7

Vehicles with Bluetooth® 2.0 interface

1. Press and hold the  button and the clock display flashes.
2. Press the  or  button to select the time notation 12-hour or 24-hour.
3. When the time notation is selected, press the  button to flash the “hours” digit.
Press the  or  button to adjust the “hours” digit.
If you keep pressing the button, fast-forward begins.
4. When the “hours” digit is adjusted, press the  button to flash the “minutes” digit.
Press the  or  button to adjust the “minutes” digit.

AM/FM electronic tuning radio with CD player-Type 2*

If you keep pressing the button, fast-forward begins.

- When the time is set, press the button to stop the clock display from flashing.

NOTE

- Reset the time after the battery terminals are disconnected and reconnected.
- Seconds do not appear in the clock display, but after adjusting the “minutes” setting, the clock begins to operate from 0 seconds.

7

To confirm the version number of the Gracenote DB (vehicles with a Bluetooth® 2.0 interface)

E00739300016

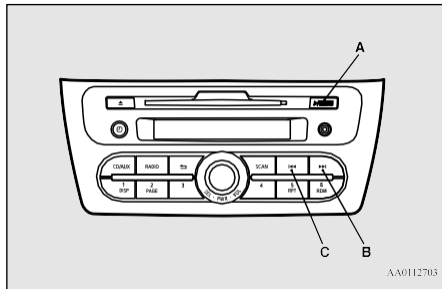

- A- /MENU button
 B- button
 C- button

7-32 For pleasant driving

- Press and hold the /MENU button until you hear a beep. “GracenoteDB” will appear on the display.

Each time the /MENU button is pressed, this switches in the order Gracenote DB, PHONE SET and cancel.

- Press the or buttons several times to select “DB Version” and press the /MENU button to determine then. The Gracenote DB version is displayed.

To change the language (vehicles with Bluetooth® 2.0 interface)

E00767000018

It is possible to set the language of used for voice control.

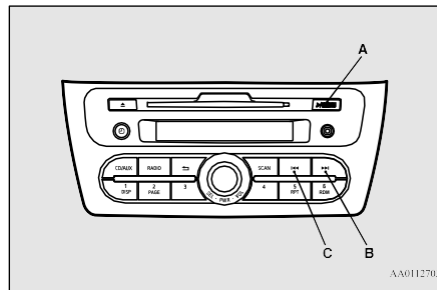

- A- /MENU button

- B- button
 C- button

- Press and hold the /MENU button until you hear a beep. “GracenoteDB” will appear on the display.

- Press the /MENU button to select “PHONE SET”.

Then press the or buttons several times to select “LANGUAGE” and then press the /MENU button to determine.

- Press the or buttons to select “LangChg YES” and then press the /MENU button to determine.

- Press the or buttons to select language and then press the /MENU button to determine.

- Press the or buttons to select “LangSet YES” and then press the /MENU button to determine.

To change the English type (vehicles with Bluetooth® 2.0 interface)

E00765700037

It is possible to set the English type of used for voice control.

AM/FM electronic tuning radio with CD player-Type 2*

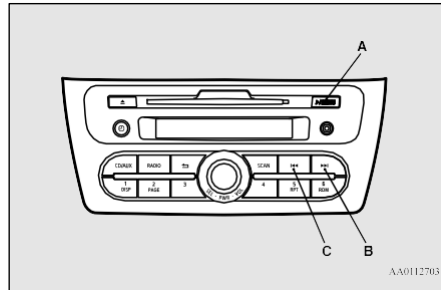

- A- /MENU button
- B- button
- C- button

1. Press and hold the /MENU button until you hear a beep. “GracernoteDB” will appear on the display.
2. Press the /MENU button to select “PHONE SET”.
Then press the button several times to select “English SET” and then press the /MENU button to determine.
3. Press the or buttons select the desired setting for English type of “OUT OF AUS” (others area) or “AUS AREA” (Australia area) and then press the /MENU button to determine.

When the ignition switch is turned to the “ON” position from the “ACC” or “LOCK”

position or when the operation mode is changed to ON from ACC or OFF, the English type becomes effective.

To change the position of the speaker of the output sound (vehicles with Bluetooth® 2.0 interface)

It is possible to change the position of the speaker of the output sound during cellular phone voice cut-in.

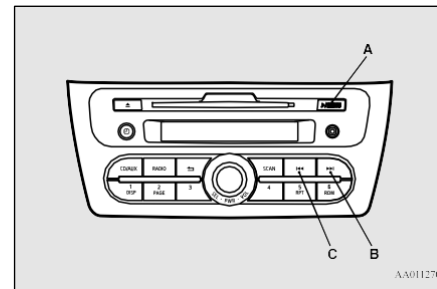

- A- /MENU button
- B- button
- C- button

1. Press and hold the /MENU button until you hear a beep. “GracernoteDB” will appear on the display.
2. Press the /MENU button to select “PHONE SET”.
Then press the or buttons several times to select “← PHONE IN →” and then press the /MENU button to determine.
3. Press the or buttons to select “IN-L” (output sound from the left side speaker) or “IN-R” (output sound from the right side speaker) and then press the /MENU button to determine.

7

To use the external audio input function

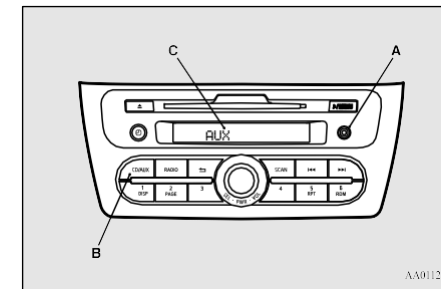

- A- Auxiliary Audio connector (Mini-jack)
- B- AUX button

To play tracks from USB device*

C- Display

You can listen to commercially available audio equipment, such as a portable audio system, from your vehicle's speakers, by connecting the audio equipment to the auxiliary audio connector.

NOTE

- Use a stereo mini-jack connector to connect the audio equipment to the auxiliary audio connector.

7

To activate the external audio input mode

E00766400044

1. Connect the headphone port of the portable audio system to the auxiliary audio connector using a commercially available connection cord.
2. Press the AUX button several times to switch to the AUX mode. The display will show "AUX" and then the external audio input mode will be activated.
3. To deactivate the external audio input mode, press the AUX button to switch to another mode.

CAUTION

- Do not operate the connected audio equipment while driving.
This could distract you and an accident might occur.

NOTE

- The connected audio equipment cannot be operated with the vehicle's audio system.
- Depending on the connected audio equipment, it may produce noise from the speakers.
- Use the connected audio equipment's own power source, such as its battery.
Noise may be produced from the speakers if the connected audio equipment is used while charging it using the accessory socket of the vehicle.
- Do not activate the external audio input mode when no audio equipment is connected.
Otherwise, noise may be produced from the speakers.
- Connect audio equipment when the external audio input mode is deactivated or lower the vehicle's speaker volume before connecting it.
Noise may be produced from the speakers if audio equipment is connected after the external audio input mode is activated.

NOTE

- Compared to the CD player mode and radio mode, the vehicle's speaker volume will be lower in the external audio input mode. Therefore, be careful when switching from the external audio input mode to the CD player mode or radio mode since the speaker volume will be higher.
- Do not use excessive force on the connection cord. Otherwise, the cord and connectors may be damaged.
- If the connection cord alone is left connected to the auxiliary audio connector, noise may be produced from the speakers.
- For information on how to connect and operate the commercially available audio equipment, refer to the owner's manual for the commercially available audio equipment.

To play tracks from USB device*

E00756101335

If your vehicle is equipped with the USB input terminal, you can connect your iPod or USB memory device to the USB input terminal and play music files stored in the iPod or USB memory device.

See the following section for the types of connectable devices and supported files.

Refer to "Types of connectable devices and supported file specifications" on page 7-74.

See the following sections for the connecting methods, “How to connect an iPod or smartphone” on page 7-74 and “How to connect a USB memory device” on page 7-74.

If your vehicle is equipped with a Bluetooth® 2.0 interface, you can play music files in your iPod or USB memory device via voice operation.

Refer to “To play iPod tracks via voice operation” on page 7-37 and “To play USB memory device tracks via voice operation” on page 7-43.

NOTE



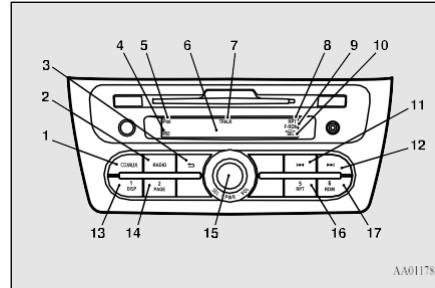

- A file protected by copyright may not be able to playback.
- It is recommended to adjust the equalizer of the connected device to 0 db or neutral.

iPod control panel and display

E00756200300



AA0117370

- 1- CD (Mode changeover) button
- 2- RADIO button
- 3-  (Return) button
- 4-  (USB device active) indicator
- 5- iPod indicator
- 6- Display
- 7- TRACK (Track number) indicator
- 8- RPT (Repeat mode) indicator
- 9- RDM (Random mode)/F-RDM (Folder random mode) indicator
- 10- SEL (Select) indicator
- 11-  (Fast-reverse/Track down) button
- 12-  (Fast-forward/Track up) button
- 13- DISP (Title display) button
- 14- PAGE (Title scroll) button
- 15- PWR (On-Off)/SEL (Select) switch
- 16- RPT (Repeat) button
- 17- RDM (Random) button

To play tracks from USB device*

To play from an iPod

E00756301483

1. Press the PWR switch to turn on the audio system. The system turns on in the last mode used.
2. Connect your iPod to the USB input terminal.
Refer to “How to connect an iPod or smartphone” on page 7-74.

3. Press the CD button several times to switch to the iPod mode. The input mode changes as follows every time the CD button is pressed: CD mode → iPod mode → Bluetooth® mode* → AUX mode → CD mode.
The iPod indicator are illuminated and then the iPod mode will be activated.

7

4. Once the device is selected, playback starts and  indicator appears on the display.

NOTE

- Depending on the condition of your iPod, it may take a longer time before the playback starts.

5. To stop the playback, press the RADIO button or CD button to switch to a different mode.

For pleasant driving 7-35

To play tracks from USB device*

NOTE

- Buttons on the iPod are disabled while the iPod is connected to the audio system.
- To adjust the volume and tone, refer to “To adjust the volume” on page 7-24 and “To adjust the tone” on page 7-25.

To fast-forward/reverse the track

E00756400139

7 To fast-forward/reverse the current track, press the ►►| button or |◄◄ button.

Fast-forward

To fast-forward the current track, press the ►►| button. While the button is kept pressed, the track will be fast-forwarded.

Fast-reverse

To fast-reverse the current track, press the |◄◄ button. While the button is kept pressed, the track will be fast-reversed.

To select a desired track

E00756500130

Track up

Press the ►►| button repeatedly until the desired track number appears on the display.

7-36 For pleasant driving

Track down

Press the |◄◄ button repeatedly until the desired track number appears on the display.

NOTE

- Pressing the |◄◄ button once during the song will cause the audio system to restart playback from the beginning of the song.

To find a track from the iPod menu

E00756600229

You can select desired tracks from the “Playlists”, “Artists”, “Albums”, “Songs” or “Genre” (vehicles with Bluetooth® 2.0 interface) menus on your iPod.

Operate the SEL switch to select desired tracks.

The selected menu or category or track is shown in the display.

When this mode is activated by pressing the SEL switch, the SEL indicator will be displayed in the display.

Press the SEL : To start this mode or to select switch the menu or category or track.

Turn the SEL : To show the menu or category or track.

NOTE

- To cancel the selection, press the ↵ button to return to the previous step.
- If no operation is performed for 10 seconds or more or other button is operated after the SEL switch has been pressed, searching of the desired tracks is cancelled.
- If no operation is performed for 5 seconds or more after the track is displayed, playback starts.
- When the SEL indicator is not shown on the display and the SEL switch is operated, the volume adjustment is effective.

To play the same track repeatedly

E00756700044

Press the RPT button during playback to show “RPT” in the display.

To exit this mode, press the button again.

To play tracks in random order

E00756900046

Press the RDM button to show “RDM” in the display.

The iPod randomly selects tracks from the current category and plays the selected tracks. To exit this mode, press the button again.

To play tracks in each album in random order

E00757000103

Press and hold the RDM button until you hear a beep to show “F-RDM” in the display. The iPod randomly selects tracks in the album from the current category and play the selected tracks.
To exit this mode, press the button again.

To switch the display

E00757100133

You can display the track titles, artist names, genre and album titles recorded in the iPod. The display changes as follows every time the DISP button is pressed during playback: Album title → Track name → Artist name → Genre (vehicles with Bluetooth® 2.0 interface) → Normal display.

NOTE

- Up to 11 characters are shown in the display at once. If the title is cut off in the middle, press the PAGE button. The next characters are displayed every time this button is pressed.
- If no title is stored, “NO TITLE” is shown in the display.
- Characters that cannot be displayed are substituted by “.”.

To play iPod tracks via voice operation (vehicles with Bluetooth® 2.0 interface)

E00757200059

Desired tracks can be selected and played from your iPod by “Artist”, “Album”, “Playlist” and “Genre” using voice commands. For information concerning the voice recognition function or speaker registration function, refer to “Bluetooth® 2.0 interface” on page 7-52.

The following explains how to prepare for voice operation and play the tracks.

Preparation for voice operation

E00757300164

To use the voice operation, press the SPEECH button (A) first.

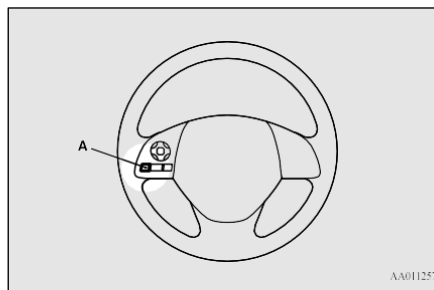

To play tracks from USB device*

To search by artist name

E00757400019

1. Say “Play” on the main menu.

NOTE

- The Bluetooth® 2.0 interface starts recognizing the connected device. If the connected device cannot be recognized or a connection error occurs, the Bluetooth® 2.0 interface starts an appropriate voice guide. Follow the voice guide.

7

2. After the voice guide says “Would you like to play by Artist, Album, Playlist or Genre?,” say “Artist”.

NOTE

- If you say “Artist <name>,” you can skip step 3.

3. After the voice guide says “What Artist would you like to play?,” say the artist name.
4. If there is only one match, the system proceeds to step 6.
5. If there are two or more matches, the voice guide will say “More than one match was found, would you like to play <artist name>?” If you say “Yes,” the system proceeds to step 6.

For pleasant driving 7-37

To play tracks from USB device*

If you say “No,” the next matching artist is uttered by the system.

NOTE

- If you say “No” to three or all artist names uttered by the system, the voice guide will say “Artist not found, please try again” and the system returns to step 2.
- Search time is dependant on the number of songs on your connected device. Devices containing a large number of songs may take longer to return search results.

7

6. After the voice guide says “Playing <artist name>,” the system creates a playlist index for the artist.

NOTE

- If the confirmation function is active, the voice guide confirms if the artist name is correct. If the artist name is correct, say “Yes”. If not, say “No”. After the voice guide says “Artist not found, please try again,” the system returns to step 2.

7. The system exits the voice recognition mode and starts playback.

To search by album title

E00757500010

1. Say “Play” on the main menu.

NOTE

- The Bluetooth® 2.0 interface starts recognizing the connected device. If the connected device cannot be recognized or a connection error occurs, the Bluetooth® 2.0 interface starts an appropriate voice guide. Follow the voice guide.

2. After the voice guide says “Would you like to play by Artist, Album, Playlist or Genre?,” say “Album”.

NOTE

- If you say “Album <title>,” you can skip step 3.

3. After the voice guide says “What Album would you like to play?” say the album title.

4. If there is only one match, the system proceeds to step 6.

5. If there are two or more matches, the voice guide will say “More than one match was found, would you like to play <album title>?” If you say “Yes,” the system proceeds to step 6.

If you say “No,” the next matching album is uttered by the system.

NOTE

- If you say “No” to three or all album titles uttered by the system, the voice guide will say “Album not found, please try again” and the system returns to step 2.

6. After the voice guide says “Playing <album title>,” the system creates a playlist index for the album title.

NOTE

- If the confirmation function is active, the voice guide confirms if the album title is correct. If the album title is correct, say “Yes”. If not, say “No”. After the voice guide says “Album not found, please try again,” the system returns to step 2.

7. The system exits the voice recognition mode and starts playback.

To search by playlist

E00757600011

1. Say “Play” on the main menu.

To play tracks from USB device*

NOTE

- The Bluetooth® 2.0 interface starts recognizing the connected device. If the connected device cannot be recognized or a connection error occurs, the Bluetooth® 2.0 interface starts an appropriate voice guide. Follow the voice guide.

2. After the voice guide says “Would you like to play by Artist, Album, Playlist or Genre?,” say “Playlist”.

NOTE

- If you say “Playlist <playlist>,” you can skip step 3. If the device has no playlist, the voice guide will say “There are no playlists stored on device” and the system returns to step 2.

3. After the voice guide says “What Playlist would you like to play?,” say the playlist name.
4. If there is only one match, the system proceeds to step 6.
5. If there are two or more matches, the voice guide will say “More than one match was found, would you like to play <playlist>?” If you say “Yes,” the system proceeds to step 6. If you say “No,” the next matching playlist name is uttered by the system.

NOTE

- If you say “No” to three or all playlist names uttered by the system, the voice guide will say “Playlist not found, please try again” and the system returns to step 2.

6. After the voice guide says “Playing <playlist>,” the system creates an index for the playlist.

NOTE

- If the confirmation function is active, the voice guide confirms if the playlist name is correct. If the playlist name is correct, say “Yes”. If not, say “No”. After the voice guide says “Playlist not found, please try again,” the system returns to step 2. Refer to “Confirmation function setting” on page 7-55.

7. The system exits the voice recognition mode and starts playback.

To search by genre

E00757700012

1. Say “Play” on the main menu.

NOTE

- The Bluetooth® 2.0 interface starts recognizing the connected device. If the connected device cannot be recognized or a connection error occurs, the Bluetooth® 2.0 interface starts an appropriate voice guide. Follow the voice guide.

2. After the voice guide says “Would you like to play by Artist, Album, Playlist or Genre?,” say “Genre”.

NOTE

- If you say “Genre <type>,” you can skip step 3.

3. After the voice guide says “What Genre would you like to play?,” say the music type.
4. If there is only one match, the system proceeds to step 6.
5. If there are two or more matches, the voice guide will say “More than one match was found, would you like to play <genre>?” If you say “Yes,” the system proceeds to step 6. If you say “No,” the next matching genre is uttered by the system.

To play tracks from USB device*

NOTE

- If you say “No” to three or all genres uttered by the system, the voice guide will say “Genre not found, please try again” and the system returns to step 2.

6. After the voice guide says “Playing <genre>,” the system creates an index for the genre.

7

NOTE

- If the confirmation function is active, the voice guide confirms if the genre is correct. If the genre is correct, say “Yes”. If not, say “No”. After the voice guide says “Genre not found, please try again,” the system returns to step 2. Refer to “Confirmation function setting” on page 7-55.

7. The system exits the voice recognition mode and starts playback.

USB control panel and display

E00758101296

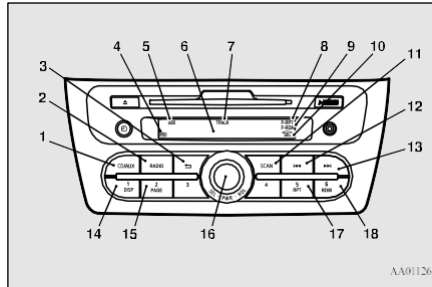

AA011244

- 1- CD (Mode changeover) button
- 2- RADIO button
- 3- (Return) button
- 4- (USB device active) indicator
- 5- USB indicator
- 6- Display
- 7- TRACK (Track number) indicator
- 8- RPT (Repeat mode)/F-RPT (Folder repeat mode) indicator
- 9- RDM (Random mode)/F-RDM (Folder random mode) indicator
- 10- SEL (Select) indicator
- 11- SCAN button
- 12- (Fast-reverse/Track down) button
- 13- (Fast-forward/Track up) button
- 14- DISP (Title display) button
- 15- PAGE (Title scroll) button
- 16- PWR (On-Off)/SEL (Select) switch

17- RPT (Repeat) button

18- RDM (Random) button

To play from a USB memory device

E00762500412

1. Press the PWR switch to turn on the audio system. The system turns on in the last mode used.
2. Connect your USB memory device to the USB input terminal.
Refer to “How to connect a USB memory device” on page 7-74.
3. Press the CD button several times to switch to the USB mode. The input mode changes as follows every time the CD button is pressed: CD mode → USB mode → Bluetooth® mode* → AUX mode → CD mode.
The USB indicator are illuminated and then the USB mode will be activated.
4. Once the device is selected, playback starts and indicator appears on the display.

NOTE

- Depending on the condition of your USB device, it may take a longer time before the playback starts.

5. To stop the playback, press the RADIO button or CD button to switch to a different mode.

NOTE

- To adjust the volume and tone, refer to “To adjust the volume” on page 7-24 and “To adjust the tone” on page 7-25.

Supported compressed music files

E00758300389

This audio can play MP3, WMA and AAC files recorded in a USB memory device. This audio supports up to 65,535 files in 700 folders on 8 levels.

Folder selection order/file playback order (example)

The folder and file hierarchy in the USB memory device is shown below.

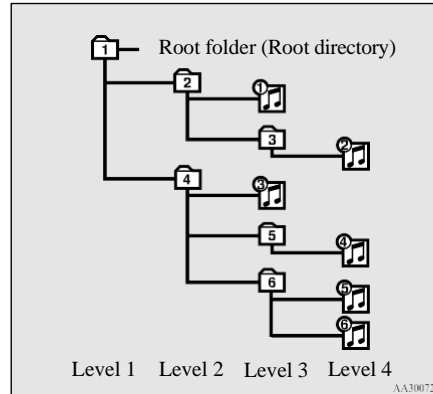

Folder selection

In the order

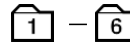

File selection

In the order

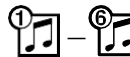

NOTE

- If a file protected by copyrights is played, the file will be skipped.

To fast-forward/reverse the track

E00758400117

To fast-forward/reverse the current track, press the ►► button or ◀◀ button.

To play tracks from USB device*

Fast-forward

To fast-forward the current track, press the ►► button. While the button is kept pressed, the track will be fast-forwarded.

Fast-reverse

To fast-reverse the current track, press the ◀◀ button. While the button is kept pressed, the track will be fast-reversed.

7

To select a file

E00758500134

Track up

Press the ►► button repeatedly until the desired file number appears on the display.

Track down

Press the ◀◀ button repeatedly until the desired file number appears on the display.

NOTE

- Pressing the ◀◀ button once during the song will cause the audio system to restart playback from the beginning of the file.

To play tracks from USB device*

To find a file

E00758600340

Operate the SEL switch to select desired file. When this mode is activated by pressing the SEL switch, the SEL indicator will be displayed in the display.

Press the SEL : To start this mode or to select switch the folder or file.

Turn the SEL : To show the folder or file. switch

7

NOTE

- To cancel the selection, press the  button to return to the previous step.
- If no operation is performed for 10 seconds or more or other button is operated after the SEL switch has been turned, searching of the desired file is cancelled.
- If no operation is performed for 5 seconds or more after the file is displayed, playback starts.
- When the SEL indicator is not shown on the display and the SEL switch is operated, the volume adjustment is effective.

To play the same file repeatedly

E00758700048

Press the RPT button to show “RPT” in the display. To cancel this mode, press the button again.

To play the files in the same folder repeatedly

E00758800108

Press and hold the RPT button until you hear a beep to show “F-RPT” in the display. All tracks in the current folder are played repeatedly.

To exit this mode, press the button again.

To play a folder in random order

E00758900109

Press the RDM button to show “F-RDM” in the display.

The audio randomly selects tracks from the current folder and plays the selected tracks.

To exit this mode, press the button again.

To play all folders in random order

E00759000107

Press and hold the RDM button until you hear a beep to show “RDM” in the display.

The audio randomly selects tracks from all folders and plays the selected tracks.

To exit this mode, press the button again.

To find the start of each track in a folder for playback (vehicles without Bluetooth® 2.0 interface)

E00759100195

Press the SCAN button. The tracks in the current folder are played for several seconds from the beginning.

The file number will blink while the scan mode is selected.

To exit this mode, press the button again.

NOTE

- Once all tracks in the folder have been cued playback will restart from the beginning of the track that was playing when cueing started.

To find the start of each track in all folders for playback (vehicles with Bluetooth® 2.0 interface)

E00765800067

Press the SCAN button. The all tracks in the all folders are played for several seconds from the beginning.

The file number will blink while the scan mode is selected.

To exit this mode, press the button again.

To find the start of first tracks in all folders for playback

E00759200167

Press and hold the SCAN button until you hear a beep.

The first tracks in all folders are played for several seconds from the beginning.

Playback starts from the folder next to the one currently playing.

The folder number will blink while the scan mode is selected.

To exit this mode, press the button again.

NOTE

- Once the cueing playback ends, playback will start from the track at the beginning of the folder next to the one that was playing when the cueing started.

To switch the display

E00759300227

You can displays titles with tag information.

Folder title

The display changes as follows every time the DISP button is pressed during playback:
Folder name → File name → Normal display.

Tag information

1. Press and hold the DISP button until you hear a beep.
2. The display changes as follows every time the DISP button is pressed briefly: Album TAG → Track TAG → Artist TAG → Genre TAG (vehicles with Bluetooth® 2.0 interface) → Normal display.

NOTE

- Press and hold the DISP button again until you hear a beep, and the tag information display returns to the folder title display.
- Up to 11 characters are shown in the display at once. If the title is cut off in the middle, press the PAGE button. The next characters are displayed every time this button is pressed.
- If no title is stored, “NO TITLE” is shown in the display.
- Characters that cannot be displayed are substituted by “.”.

To play tracks from USB device*

To play USB memory device tracks via voice operation (vehicles with Bluetooth® 2.0 interface)

E00759400169

Desired tracks can be selected and played from your USB memory device by “Artist”, “Album”, “Playlist” and “Genre” using voice commands.

For information concerning the voice recognition function or speaker registration function, refer to “Bluetooth® 2.0 interface” on page 7-52.

The playback sequence of tracks is the same as when an iPod is connected. Refer to the “To play iPod tracks via voice operation” on page 7-37.

Preparation for voice operation

To use the voice operation, press the SPEECH button (A) first.

7

To play tracks from a Bluetooth® device (vehicles with Bluetooth® 2.0 interface)

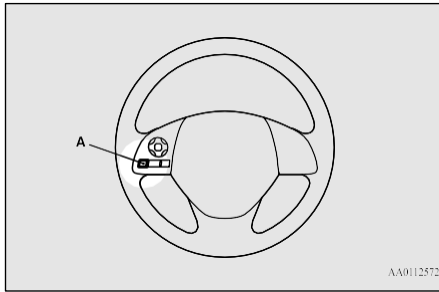

7

To play tracks from a Bluetooth® device (vehicles with Bluetooth® 2.0 interface)

E00759700188

You can wirelessly connect a digital audio player or cellular phone supporting Bluetooth® to listen to the tracks on the connected device.

Refer to “Bluetooth® 2.0 interface” for the connecting method, etc. on page 7-52.

The following explains the basic playback method.

7-44 For pleasant driving

NOTE

- The connected Bluetooth® device may not operate correctly or its function may be limited.
- A file protected by copyright may not be able to playback.
- It is recommended to adjust the equaliser of the connected device to 0 db or neutral.
- The voice operation is not available to access music files on the connected Bluetooth® device.

Bluetooth® device control panel and display

E00762600194

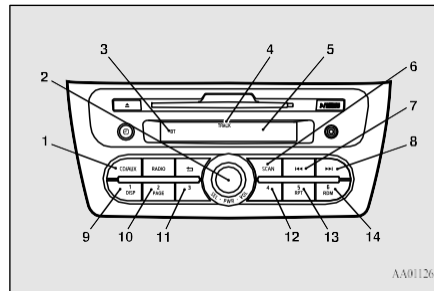

- 1- CD (Mode changeover) button
- 2- PWR (On-Off) switch
- 3- BT (Bluetooth®) indicator
- 4- TRACK (Track number) indicator
- 5- Display

- 6- SCAN button
- 7- ◀◀ (Fast-reverse/Track down) button
- 8- ▶▶ (Fast-forward/Track up) button
- 9- DISP (Title display) button
- 10- PAGE (Title scroll) button
- 11- Play/Pause button
- 12- Stop button
- 13- RPT (Repeat) button
- 14- RDM (Random) button

To listen to tracks from a device connected via Bluetooth®

E00762700267

1. Press the PWR switch to turn on the audio system. The system turns on in the last mode used.
2. Press the CD button several times to switch to the BT-A (Bluetooth®) mode. The input mode changes as follows every time the CD button is pressed: CD mode → iPod mode → Bluetooth® mode* → AUX mode → CD mode. The BT indicator are illuminated and then the BT-A mode will be activated.
3. Connect your Bluetooth® device. Refer to “Connecting the Bluetooth® 2.0 interface and Bluetooth® device” on page 7-58.
4. Playback starts automatically.

NOTE

- Depending on the connected device, the playback may not start automatically. In this case, operate the connected device to start the playback.

To stop the playback (if supported by the device)

E00762800082

To stop the playback, press the Stop button.
To restart the playback, press the Play/Pause button.

To pause the playback (if supported by the device)

E00762900096

To pause the playback, press and hold the Play/Pause button until you hear a beep.
To restart the playback, press the Play/Pause button.

To fast-forward/reverse the track (if supported by the device)

E00765600023

To fast-forward/reverse the current track, press the ►► button or ◀◀ button.

To play tracks from a Bluetooth® device (vehicles with Bluetooth® 2.0 interface)**Fast-forward**

To fast-forward the current track, press the ►► button. While the button is kept pressed, the track will be fast-forwarded.

Fast-reverse

To fast-reverse the current track, press the ◀◀ button. While the button is kept pressed, the track will be fast-reversed.

To select a track (if supported by the device)

E00763000108

Track up

Press the ►► button repeatedly until the desired file number appears on the display.

Track down

Press the ◀◀ button repeatedly until the desired file number appears on the display.

NOTE

- Pressing the ◀◀ button once during the song will cause the audio system to restart playback from the beginning of the file.

To play the same track repeatedly (if supported by the device)

E00766900010

Press the RPT button several times to switch to show “RPT” in the display.

The mode changes as follows every time the RPT button is pressed:

No display (not repeat) → RPT (repeat same track) → F-RPT (repeat all tracks) → No display

To exit this mode, press the button again.

7**To play the all tracks repeatedly (if supported by the device)**

E00766800019

Press the RPT button several times to switch to show “F-RPT” in the display.

The mode changes as follows every time the RPT button is pressed:

No display (not repeat) → RPT (repeat same track) → F-RPT (repeat all tracks) → No display

All tracks in the Bluetooth® device are played repeatedly.

To exit this mode, press the button again.

Steering wheel audio remote control switches*

To play tracks in random order (if supported by the device)

E00763200083

Press the RDM button to show “RDM” in the display.

The system randomly selects and plays tracks from all tracks in the Bluetooth® device.

To exit this mode, press the button again.

7

To find the start of each track for playback (if supported by the device)

E00763300114

Press the SCAN button. The all tracks in the Bluetooth® device are played for several seconds from the beginning.

To exit this mode, press the button again.

To switch the display (if supported by the device)

E00763400098

The system can display tag information.

1. Press the DISP button.
2. The display changes as follows every time the DISP button is pressed:
Album title → Title name → Artist name
→ Genre → Normal display

NOTE

- Up to 11 characters are shown in the display at once. If the title is cut off in the middle, press the PAGE button. The next characters are displayed every time this button is pressed.
- If no title is stored, “NO TITLE” is shown in the display.
- Characters that cannot be displayed are substituted by “•”.

Steering wheel audio remote control switches*

E00710002122

The remote control switches are located on the left side of the steering wheel. These switches can be used when the ignition switch or the operation mode is in ON or ACC.

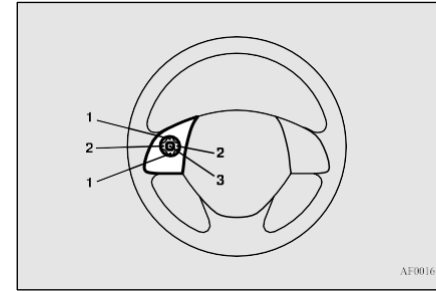

- 1- ▲ button, ▼ button
Adjust audio functions and the mobile phone function volume.
- 2- < button, > button
Select CD and other audio source tracks and radio stations.
Hold down to skip up and down through tracks.
- 3- MODE button
Hold down to turn the audio function ON/OFF. Additionally, each time this is pressed, this switches the audio source. The order of switching is as shown below.

Steering wheel audio remote control switches*

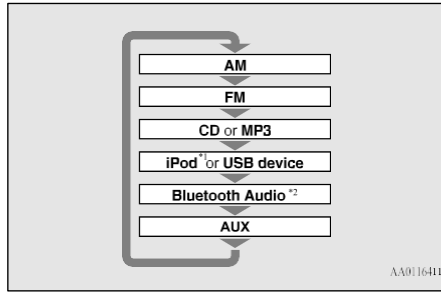

- *1: An iPod cable (available separately) is required.
- *2: Requires a separately-purchased Bluetooth-capable audio device (vehicles with a Bluetooth® 2.0 interface).

Error codes

Error codes

E00710102370

If an error code appears in the display, take action in accordance with the table below.

Audio system**7**

Type 1* ¹	Type 2* ²	Item	Repair
CD ERR1	CHECK DISC	Disc is not loaded correctly, or condensation on disc.	Insert disc with label facing up. Remove moisture from disc.
CD ERR2	DISC ERROR	Disc is dirty, scratched, or deformed; or excessive vehicle vibration.	Clean or replace disc. Retry when vibrations stop.
CD ERR3	INTERNAL E	Loading or eject error. Pick-up is out of position.	Eject disc and reload. If disc will not eject, have the equipment inspected.
CD ERR4	—	The MP3 file compression format cannot be recognized.	Record MP3 files of the recognized compression format in the CD.
ERR HOT	HEAT ERROR	Internal protection against high temperatures.	Allow radio to cool by waiting about 30 minutes.
PROTECT	ERROR DC	Foreign material is inside of radio or amplifier.	Bring your vehicle to an authorised MITSUBISHI MOTORS dealer.

*¹: AM/FM electric tuning radio with CD player-Type 1

*²: AM/FM electric tuning radio with CD player-Type 2

iPod*

Error display	Item	Repair
NO SONG	There are no playable music files.	Record music files in the iPod.

7-48 For pleasant driving

Error codes

Error display	Item	Repair
VER ERROR	The iPod or its software cannot be recognized.	Connect a supported iPod.

USB memory device*

Error display	Item	Repair
FILE ERROR	The file cannot be played.	The file is protected by copyrights, etc. An error is displayed for several seconds, and then the next playable file is played automatically.
UNSUPPORTED (first) → DEVICE (after)	The USB memory device cannot be recognized.	Remove the USB memory device.
UNSUPPORTED (first) → FORMAT (after)	The USB memory device format cannot be recognized.	Remove the USB memory device.
USB BUS PWR	An overcurrent or other power-supply error has occurred.	Remove the USB memory device. Have the vehicle inspected at an authorised MITSUBISHI MOTORS dealer.
LSI ERROR	Internal device errors	Have the vehicle inspected at an authorised MITSUBISHI MOTORS dealer.

7

Handling of compact discs

Handling of compact discs

E00723001451

- Use only the type of compact discs that have the mark shown in the illustration below. (Playback of CD-R or CD-RW discs may cause problems.)



7

- The use of special shaped or low-quality compact discs such as those shown below will damage the CD player.

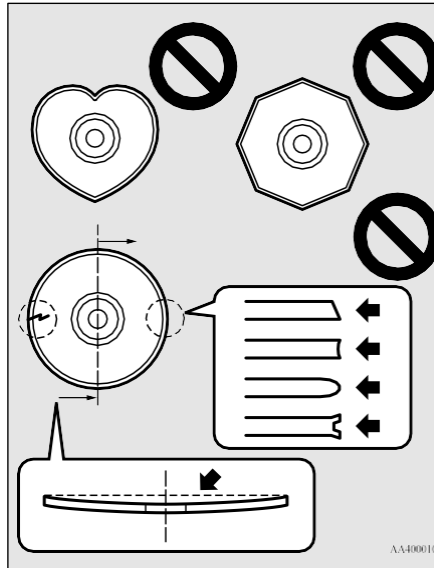

- When the temperature suddenly rises, i.e. immediately after the heater is turned on in cold weather, dew condensation on the disc or in the player might occur resulting in failure of operation. In such a case, allow some time before use.
- When the CD player is subjected to violent vibration as during off-road driving, detacking may result.
- When storing compact discs, always store them in their individual cases.

Never place compact discs in direct sunlight, or in any place where the temperature or humidity is high.

- Take care never to touch the flat surface of the disc where there is no label. Doing so will contaminate the disc surface and might adversely affect the sound quality. When handling a compact disc, always hold it by grasping the outer circumference and the centre hole.
- To clean the disc, use a soft, clean, dry cloth. Wipe directly from the centre hole towards the outer-edge; do not wipe in a circular pattern. Never use any substances such as benzine, paint thinner, a disc spray cleaner, or an anti-static agent on the disc.
- Do not use a ballpoint pen, felt pen, pencil, etc. to write on the label surface of the disc, and do not attach any other labels, seals, etc.
- Do not put additional labels or stickers on compact discs. Also, do not use any compact disc on which a label or sticker has started to peel off or any compact disc that has stickiness or other contamination left by a peeledoff label or sticker. If you use such a compact disc, the CD player may stop working properly and you may not be able to eject the compact disc.

Notes on CD-Rs/RWs

E00725100114

- You may have trouble playing back some CD-R/RW discs recorded on CD recorders (CD-R/RW drives), either due to their recording characteristics or dirt, fingerprints, scratches, etc. on the disc surface.
- CD-R/RW discs are less resistant to high temperatures and high humidity than ordinary music CDs and can therefore be damaged and rendered unplayable if left inside your vehicle for a long time.
- Depending on the combination of the writing software, the CD recorder (CD-R/RW drive), and the disc used to create a CD-R/RW, the disc might not play successfully.
- This player cannot play the CD-R/RW discs if the session is not closed.
- This player cannot play CD-R/RW discs which contain data other than CD-DA or MP3 data (Video CD, etc.).
- Be sure to observe the handling instructions for the CD-R/RW disc.

WARNING

- **Operating the CD player in a manner other than specifically instructed herein may result in hazardous radiation exposure. Do not remove the cover and attempt to repair the CD player by yourself. There are no user serviceable parts inside. In case of malfunction, contact an authorised MITSUBISHI MOTORS dealer.**

Antenna

E00710501700

To remove

Turn the pole (A) anticlockwise.

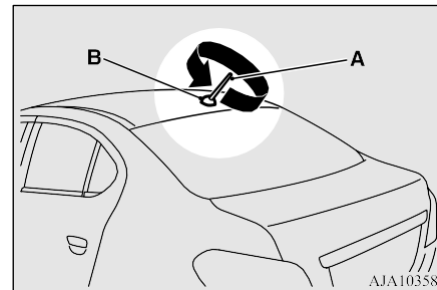

Antenna

To install

Screw the pole (A) clockwise into the base (B) until it is securely retained.

NOTE

- Be sure to remove the roof antenna in the following cases:
 - When going into an automatic car wash.
 - When placing a car cover over the vehicle.
 - When driving into a structure that has a low ceiling.

7

Link System*

E00764501673

The Link System takes overall control of the devices connected via the USB input terminal or the Bluetooth® 2.0 interface allowing the connected devices to be operated by using the switches in the vehicle or voice commands. See the following section for details on how to operate.

Refer to “Bluetooth® 2.0 interface” on page 7-52.

Refer to “USB input terminal” on page 7-73.
Refer to “To play tracks from USB device” on page 7-34.

For pleasant driving 7-51

Bluetooth® 2.0 interface*

Refer to “To play iPod tracks via voice operation” on page 7-37.

Refer to “To play tracks from a Bluetooth® device” on page 7-44.

Bluetooth® is a registered trademark of BLUETOOTH SIG, INC.

Link System End User License Agreement

7

E00764601111

You have acquired a device that includes software licensed by MITSUBISHI MOTORS CORPORATION from Visteon Corporation, and their subsequent 3rd party suppliers. For a complete list of these 3rd party products and their end user license agreements, please go to the following website.

<http://www.jciblueconnect.com/faq/fulldisclosure.pdf>

Bluetooth® 2.0 interface*

E00726002101

The Bluetooth® 2.0 interface allows for making/receiving hands-free calls in the vehicle using a Bluetooth® compatible cellular phone based on the wireless communication technology commonly known as Bluetooth®. It also allows the user to play music, saved in a

7-52 For pleasant driving

Bluetooth® music player, from the vehicle’s speakers.

The system is equipped with a voice recognition function, which allows you to make hands-free calls by simple switch operations and voice command operations using a defined voice tree.

The Bluetooth® 2.0 interface can be used when the ignition switch or the operation mode is in ON or ACC.

Before you can use the Bluetooth® 2.0 interface, you must pair the Bluetooth® device and Bluetooth® 2.0 interface. Refer to “Connecting the Bluetooth® 2.0 interface and Bluetooth® device” on page 7-58.

Bluetooth® is a registered trademark of BLUETOOTH SIG, INC.

WARNING

- **Although the Bluetooth® 2.0 interface allows you to make hands-free calls, if you choose to use the cellular phone while driving, you must not allow yourself to be distracted from the safe operation of your vehicle. Anything, including cellular phone usage, that distracts you from the safe operation of your vehicle increases your risk of an accident.**

WARNING

- **Refer to and comply with all state and local laws in your area regarding cellular phone usage while driving.**

NOTE

- For vehicles equipped with the keyless operation system, if the operation mode is left in ACC, the accessory power will automatically turn off after a certain period of time and you will no longer be able to use the Bluetooth® 2.0 interface. The accessory power comes on again if the engine switch is operated. Refer to “ACC power auto-cutout function” on page 6-13.
- The Bluetooth® 2.0 interface cannot be used if the Bluetooth® device has a flat battery or the device power is turned off.
- Hands-free calls will not be possible if your phone does not have service available.
- If you place the Bluetooth® device in the luggage compartment, you may not be able to use the Bluetooth® 2.0 interface.
- Some Bluetooth® devices are not compatible with the Bluetooth® 2.0 interface.
- You can confirm the Link System software version by pressing the HANG-UP button 3 times (press and hold 2 times and then press briefly) within 10 seconds.

NOTE

- For detail of the Bluetooth® 2.0 interface, access the MITSUBISHI MOTORS website. Please read and agree to the “Warning about Links to the Web Sites of Other Companies”. The websites mentioned above may connect you to websites other than the MITSUBISHI MOTORS website.
<http://www.mitsubishi-motors.com/en/products/index.html>
 You may not be able to use above website depending on your area.
- Software updates by cellular phone/digital audio device manufacturers may change/alter device connectivity.

Steering control switch and microphone → P.7-53

Voice recognition function → P.7-54

Useful voice commands → P.7-55

Speaker enrollment function → P.7-56

Connecting the Bluetooth® 2.0 interface and the Bluetooth® device → P.7-58

Operating a music player connected via Bluetooth® → P.7-63

How to make or receive hands-free calls → P.7-63

Phonebook function → P.7-66

Steering control switch and microphone

E00727200337

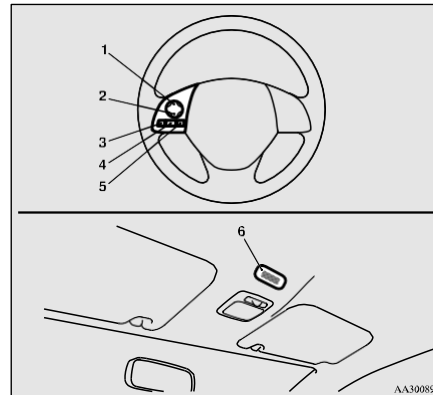

- 1- Volume up button
- 2- Volume down button
- 3- SPEECH button
- 4- PICK-UP button
- 5- HANG-UP button
- 6- Microphone

Volume up button

Press this button to increase the volume.

Volume down button

Press this button to decrease the volume.

SPEECH button

- Press this button to change to voice recognition mode.
 While the system is in voice recognition mode, “Listening” will appear on the audio display.
- If you press the button briefly while in voice recognition mode, it will interrupt prompting and allow voice command input.
 Pressing the button longer will deactivate the voice recognition mode.
- Pressing this button briefly during a call will enable voice recognition and allow voice command input.

PICK-UP button

- Press this button when an incoming call is received to answer the telephone.
- When another call is received during a call, press this button to put the first caller on hold and talk to the new caller.

Bluetooth® 2.0 interface*

- In such circumstances, you can press the button briefly to switch between callers. You will switch to the first caller and the other caller will be put on hold.
- To establish a three-way call in such situations, press the SPEECH button to enter voice recognition mode and then say “Join calls.”

HANG-UP button

7

- Press this button when an incoming call is received to refuse the call.
- Press this button during a call to end the current call.
When another call is on hold, you will switch to that call.
- If this button is pressed in the voice recognition mode, the voice recognition mode will be deactivated.

NOTE

- When you press the SPEECH button to enter voice recognition mode with a cellular phone paired to the system, current information on the cellular phone, such as “remaining battery life,” “signal strength” or “roaming,” will be displayed on the audio display.*
*: Some cellular phones will not send this information to the Bluetooth® 2.0 interface.

NOTE

- Call waiting and three-way calls can be used by the Bluetooth® 2.0 interface, only if it is possible to use those services with your cellular phone.

Microphone

Your voice will be recognized by a microphone in the overhead console, allowing you to make hands-free calls with voice commands.

NOTE

- If a cellular phone is brought close to the microphone, it may create noise in the voice on the phone. In such a case, take the cellular phone at a place as far as possible from the microphone.

Voice recognition function

E00727301797

The Bluetooth® 2.0 interface is equipped with a voice recognition function. Simply say voice commands and you can perform various operations and make or receive hands-free calls.

With the Bluetooth® 2.0 interface, voice recognition is possible for English, French,

Spanish, Italian, German, Dutch, Portuguese and Russian. The factory setting is “English” or “Russian.”

NOTE

- If the voice command that you say differs from the predefined command or cannot be recognised due to ambient noise or some other reason, the Bluetooth® 2.0 interface will ask you for the voice command again up to 3 times.
- For best performance and further reduction of ambient noise, the vehicle windows should be closed, lower the blower speed and refrain from conversation with your passengers while engaging the voice recognition function.
- Some voice commands have alternative commands.
- Depending on the selected language, some functions may not be available.
- Language can be changed by using the audio control panel besides the following procedure.
For details, refer to “To change the language (vehicles with Bluetooth® 2.0 interface)” on page 7-32.

Selecting the language

1. Press the SPEECH button.
2. Say “Setup.”

3. Say "Language."
4. The voice guide will say "Select a language: English, French, Spanish, Italian, German, Dutch, Portuguese or Russian" Say the desired language. (Example: "English")
5. The voice guide will say "English (French, Spanish, Italian, German, Dutch, Portuguese or Russian) selected. Is this correct?" Say "Yes."
If you say "No," the system will return to Step 4.

NOTE

- The voice guide will repeat the same message twice. The first message is in the current language, and the second message is in the selected language.
- If many entries are registered in the vehicle phonebook, changing the language will take a longer time.
- Changing the language deletes the mobile phonebook imported to the Bluetooth® 2.0 interface. If you wish to use it, you will have to import it again.

6. When the voice guide says "English (French, Spanish, Italian, German, Dutch, Portuguese or Russian) selected," the language change process will be completed and the system will return to the main menu.

Useful voice commands

E0076000019

Help function

E00760100010

The Bluetooth® 2.0 interface is equipped with a help function.

If you say "Help" when the system is waiting for a voice command input, the system will tell you a list of the commands that can be used under the circumstances.

Canceling

E00760201021

There are 2 cancel functions.

If you are at the main menu, say "Cancel" to exit from the Bluetooth® 2.0 interface.

If you are anywhere else within the system, say "Cancel" to return to the main menu.

NOTE

- You can return to the previous menu by saying "Go Back." (if so equipped)

Confirmation function setting

E00760400013

The Bluetooth® 2.0 interface is equipped with a confirmation function.

Bluetooth® 2.0 interface*

With the confirmation function activated, you are given more opportunities than normal to confirm a command when making various settings to the Bluetooth® 2.0 interface. This allows you to decrease the possibility that a setting is accidentally changed.

The confirmation function can be turned on or off by following the steps below.

1. Press the SPEECH button.
2. Say "Setup."
3. Say "Confirmation prompts."
4. The voice guide will say "Confirmation prompts are <on/off>. Would you like to turn confirmation prompts <off/on>." Answer "Yes" to change the setting or answer "No" to keep the current setting.
5. The voice guide will say "Confirmation prompts are <off/on>" and then the system will return to the main menu.

7

Security function

E00760501516

It is possible to use a password as a security function by setting a password of your choice for the Bluetooth® 2.0 interface.

When the security function is turned on, it is necessary to make a voice input of a 4-digit password in order to use all functions of the Bluetooth® 2.0 interface, except for reception.

Bluetooth® 2.0 interface*

Setting the password

Use the following procedure to turn on the security function by setting a password.

1. Press the SPEECH button.
2. Say "Setup."
3. Say "Password."
4. The voice guide will say "Password is disabled. Would you like to enable it?" Answer "Yes."

7

- Answer "No" to cancel the setting of the password and return to the main menu.
5. The voice guide will say "Please say a 4-digit password. Remember this password. It will be required to use this system." Say a 4-digit number which you want to set as a password.
 6. For confirmation purposes, the voice guide will say "Password <4-digit password>. Is this correct?" Answer "Yes." Answer "No" to return to the password input in Step 5.
 7. When the registration of the password is completed, the voice guide will say "Password is enabled" and the system will return to the main menu.

NOTE

- Password will be required to access the system after the next ignition cycle.

NOTE

- It is required for a little time after engine stop that the entered password is actually recorded in the system.
If the ignition switch or the operation mode is made to ACC or ON or the engine is started immediately after engine stop, there is a case when the entered password is not recorded in the system. At this time, please try to enter the password again.

Entering the password

If a password has been set and the security function is enabled, the voice guide will say "Hands-free system is locked. State the password to continue" when the SPEECH button is pressed to enter voice recognition mode. Say the 4-digit password number to enter the password.

If the entered password is wrong, the voice guide will say "<4-digit password>, Incorrect password. Please try again." Enter the correct password.

NOTE

- You can reenter the password as many times as you want.
- If you have forgotten your password, say "Cancel" to quit the voice input mode and then check with an authorised MITSUBISHI MOTORS dealer.

Disabling the password

Use the following procedure to turn off the security function by disabling the password.

NOTE

- System must be unlocked to disable the password.

1. Press the SPEECH button.
2. Say "Setup."
3. Say "Password."
4. The voice guide will say "Password is enabled. Would you like to disable it?" Answer "Yes."
Answer "No" to cancel the disabling of the password and return to the main menu.
5. When the disabling of the password is completed, the voice guide will say "Password is disabled" and the system will return to the main menu.

Speaker enrollment function

E00727400209

The Bluetooth® 2.0 interface can use the speaker enrollment function to create a voice model for one person per language.

Bluetooth® 2.0 interface*

This makes it easier for the Bluetooth® 2.0 interface to recognise voice commands said by you.

You can turn a voice model registered with the speaker enrollment function on and off whenever you want.

Speaker enrollment

E00727500271

It takes about 2 to 3 minutes to complete the speaker enrollment process.

To ensure the best results, run through the process while in the driver's seat, in an environment that is as quiet as possible (when there is no rain or strong winds and the vehicle windows are closed). Please turn off your phone while in speaker enrollment to prevent interruption of the process.

Use the following procedure for speaker enrollment.

1. Stop your vehicle in a safe area, put the gearshift lever (M/T) in the "N" (Neutral) position, or the selector lever (CVT) in the "P" (PARK) position, and pull the parking brake lever.

NOTE

- Speaker enrollment is not possible unless the vehicle is parked. Make sure you park the vehicle in a safe area before attempting speaker enrollment.

2. Press the SPEECH button.
3. Say "Voice training."
4. The voice guide will say "This operation must be performed in a quiet environment while the vehicle is stopped. See the owner's manual for the list of required training phrases. Press and release the SPEECH button when you are ready to begin. Press the HANG-UP button to cancel at any time."
Press the SPEECH button to start the speaker enrollment process.

NOTE

- If you do not start the speaker enrollment process within 3 minutes after pressing the SPEECH button, the speaker enrollment function will time out.
The voice guide will say "Speaker enrollment has timed out." The system will then beep and the voice recognition mode will be deactivated.

5. The voice guide will prompt for phrase 1. Repeat the corresponding phrase listed in table "Enrollment commands" on page 7-73.
The system will register your voice and then move on to the registration of the next command. Continue the process until all phrases have been registered.

NOTE

- To repeat the most recent voice training command, press and release the SPEECH button.
- If you press the HANG-UP button anytime during the process, the system will beep and stop the speaker enrollment process.

6. When all enrollment commands have been read out, the voice guide will say "Speaker enrollment is complete." The system will then end the speaker enrollment process and return to the main menu.

7

NOTE

- Completing the speaker enrollment process will turn on the voice model automatically.
- The commands "Help" and "Cancel" will not work in this mode.

Enabling and disabling the voice model and retraining

E00727600096

You can turn a voice model registered with the speaker enrollment function on and off whenever you want.

You can also retrain the system.

Use the following procedure to perform these actions.

1. Press the SPEECH button.

For pleasant driving 7-57

Bluetooth® 2.0 interface*

2. Say “Voice training.”
3. If you have completed a speaker enrollment process once already, the voice guide will say either “Enrollment is enabled. Would you like to disable or retrain?” or “Enrollment is disabled. Would you like to enable or retrain?”
4. When enrollment is “enabled,” the voice model is on; when enrollment is “disabled,” the voice model is off. Say the command that fits your needs.
Say “Retrain” to start the speaker enrollment process and recreate a new voice model. (Refer to “Speaker enrollment” on page 7-57.)

7

Connecting the Bluetooth® 2.0 interface and Bluetooth® device

E00760602022

Before you can make or receive hands-free calls or play music using the Bluetooth® 2.0 interface function, you must pair the Bluetooth® device and Bluetooth® 2.0 interface.

NOTE

- Pairing is required only when the device is used for the first time. Once the device has been paired with the Bluetooth® 2.0 interface, all you need is to bring the device into the vehicle next time and the device will connect to the Bluetooth® 2.0 interface automatically (if supported by the device). The device must have Bluetooth® turned ON to connect.

Up to 7 Bluetooth® devices can be paired with the Bluetooth® 2.0 interface.

If multiple paired Bluetooth® devices are available in the vehicle, the cellular phone or music player most recently connected is automatically connected to the Bluetooth® 2.0 interface.

You can also change a Bluetooth® device to be connected.

To pair

To pair a Bluetooth® device with the Bluetooth® 2.0 interface, use either one of the following 2 methods (Type 1 or Type 2).

■ Pairing procedure - Type 1*

1. Stop your vehicle in a safe area, put the gearshift lever (M/T) in the “N” (Neutral) position, or the selector lever (CVT) in the “P” (PARK) position, and pull the parking brake lever.

NOTE

- You cannot pair any Bluetooth® device with the Bluetooth® 2.0 interface unless the vehicle is parked. Before pairing a Bluetooth® device with the Bluetooth® 2.0 interface, confirm that the vehicle is parked in a safe location.

2. Press the SPEECH button.
3. Say “Setup.”
4. Say “Pairing Options.”
5. The voice guide will say “Select one of the following: pair, edit, delete, or list.” Say “Pair.”

NOTE

- If 7 devices have already been paired, the voice guide will say “Maximum devices paired” and then the system will end the pairing process. To register a new device, delete one device and then repeat the pairing process.
(Refer to “Selecting a device: Deleting a device” on page 7-62.)

Bluetooth® 2.0 interface*

6. The voice guide will say “Please say a 4-digit pairing code.” Say a 4-digit number. When the confirmation function is on, the system will confirm whether the number said is acceptable. Answer “Yes.” Answer “No” to return to pairing code selection.

NOTE

- Some Bluetooth® devices require a specific pairing code. Please refer to the device manual for pairing code requirements.
- The pairing code entered here is only used for the Bluetooth® connection certification. It is any 4-digit number the user would like to select. Remember the pairing code as it needs to be keyed into the Bluetooth® device later in the pairing process. Depending on the connection settings of the Bluetooth® device, this code may have to be entered each time you connect the Bluetooth® device to the Bluetooth® 2.0 interface. For the default connection settings, refer to the instructions for the device.

7. The voice guide will say “Start pairing procedure on the device. See the device manual for instructions.” Enter in the Bluetooth® device the 4-digit number you have registered in Step 6.

NOTE

- According to the corresponding device to Bluetooth®, it might take a few minute to pair the Bluetooth® device with the Bluetooth® 2.0 interface.
- If the Bluetooth® 2.0 interface cannot recognize the Bluetooth® device, the voice guide will say “Pairing has timed out” and the pairing process will be cancelled. Confirm that the device you are pairing supports Bluetooth®, and try pairing it again.
- If you enter the wrong number, the voice guide will say “Pairing failed” and the pairing process will be cancelled. Confirm the number is right, and try pairing it again.

8. The voice guide will say “Please say the name of the device after the beep.” You can assign a desired name for the Bluetooth® device and register it as a device tag. Say the name you want to register after the beep.

NOTE

- When the confirmation function is on, after repeating the device tag you have said, the voice guide will ask “Is this correct?” Answer “Yes.” To change the device tag, answer “No” and then say the device tag again.

9. The voice guide will say “Pairing complete,” and the pairing process will end.

■ **Pairing procedure - Type 2***

1. Stop your vehicle in a safe area, put the gearshift lever (M/T) in the “N” (Neutral) position, or the selector lever (CVT) in the “P” (PARK) position, and pull the parking brake lever.

NOTE

- You cannot pair any Bluetooth® device with the Bluetooth® 2.0 interface unless the vehicle is parked. Before pairing a Bluetooth® device with the Bluetooth® 2.0 interface, confirm that the vehicle is parked in a safe location.

2. Press the SPEECH button.
3. Say “Pair Device.”

Bluetooth® 2.0 interface*

 **NOTE**

- The following procedure (① to ③) can also be used instead of saying “Pair Device.” Replace this step 3 with the following procedure if you prefer.

① Say “Setup.”

② Say “Pairing Options.”

③ The voice guide will say “Select one of the following: pair, edit, delete, list or set code.”

Say “Pair.”

- If 7 devices have already been paired, the voice guide will say “Maximum devices paired” and then the system will end the pairing process. To register a new device, delete one device and then repeat the pairing process. (Refer to “Selecting a device: Deleting a device” on page 7-62.)

4. The voice guide will say “Start pairing procedure on the device. See the device manual for instructions.” and then will say “The pairing code is <pairing code>.”

 **NOTE**

- Some Bluetooth® devices require a specific pairing code. Please refer to the device manual for pairing code requirements and read the next section “If your device requires a specific pairing code” on page 7-61 to set the pairing code.

7 **NOTE**

- The pairing code entered here is only used for the Bluetooth® connection certification. Depending on the connection settings of the Bluetooth® device, this code may have to be entered each time you connect the Bluetooth® device to the Bluetooth® 2.0 interface. For the default connection settings, refer to the instructions for the device.

5. Enter in the Bluetooth® device the 4-digit number that has been read out in Step 4.

 **NOTE**

- According to the corresponding device to Bluetooth®, it might take a few minute to pair the Bluetooth® device with the Bluetooth® 2.0 interface.
- If the Bluetooth® 2.0 interface cannot recognize the Bluetooth® device, the voice guide will say “Pairing has timed out” and the pairing process will be cancelled. Confirm that the device you are pairing supports Bluetooth®, and try pairing it again.

 **NOTE**

- If you enter the wrong number, the voice guide will say “Pairing failed” and the pairing process will be cancelled. Confirm the number is right, and try pairing it again. If your device requires a specific pairing code, you need to set the pairing code. Refer to the device manual for pairing code requirements and read the next section “If your device requires a specific pairing code” on page 7-61.

6. The voice guide will say “Please say the name of the device after the beep.” You can assign a desired name for the Bluetooth® device and register it as a device tag. Say the name you want to register after the beep.

 **NOTE**

- When the confirmation function is on, after repeating the device tag you have said, the voice guide will ask “Is this correct?” Answer “Yes.” To change the device tag, answer “No” and then say the device tag again.

Bluetooth® 2.0 interface*

7. The voice guide will say “Pairing Complete. Would you like to import the contacts from your mobile device now?” Answer “Yes,” and the voice guide will say “Please wait while the contacts are imported. This may take several minutes.” Answer “No” to end the pairing process.

If your device requires a specific pairing code

If your device requires a specific pairing code, you need to set the pairing code. Follow the procedures below.

1. Press the SPEECH button.
2. Say “Setup.”
3. Say “Pairing Options.”
4. Say “Set Code.”
5. The voice guide will say “Do you want the pairing code to be random or fixed?” Say “Fixed.”
6. The voice guide will say “Please say a 4-digit pairing code.” Say a 4-digit number.
7. The voice guide will say “Pairing code set to <pairing code>.”

When the confirmation function is on, the system will confirm whether the number said is acceptable. Answer “Yes.” Answer “No,” the system will return to Step 6.

8. The voice guide will say “Do you want to pair a device now?” Answer “Yes,” the system will proceed to Step 3 in the pairing process. Refer to the “Pairing procedure- Type 2.”

Selecting a device

E00760701202

If multiple paired Bluetooth® devices are available in the vehicle, the cellular phone or music player most recently connected is automatically connected to the Bluetooth® 2.0 interface.

You can connect to the other paired cellular phone or music player by following setting change procedures.

■ To select a cellular phone

1. Press the SPEECH button.
2. Say “Setup.”
3. Say “Select phone.”
4. After the voice guide says “Please say,” the numbers of the cellular phones and device tags of corresponding cellular phones will be read out in order, starting with the cellular phone that has been most recently connected.
Say the number of the cellular phone that you want to connect to.

When the confirmation function is on, the system will ask you again whether the phone that you want to connect to is correct. Answer “Yes” to continue and connect to the cellular phone.

Answer “No,” and the voice guide will say “Please say.” Say the number of the phone that you want to connect to.

NOTE

- You can connect to a phone at any time by pressing the SPEECH button and saying the number, even before all of the paired numbers and device tags of corresponding cellular phones are read out by the system.

7

5. The selected phone will be connected to the Bluetooth® 2.0 interface. The voice guide will say “<device tag> selected” and then the system will return to the main menu.

■ To select a music player

1. Press the SPEECH button.
2. Say “Setup.”
3. Say “Select music player.”

Bluetooth® 2.0 interface*

4. After the voice guide says “Please say,” the numbers of the music players and device tags of corresponding music players will be read out in order, starting with the music player that has been most recently connected.

Say the number of the music player that you want to connect to.

When the confirmation function is on, the system will ask you again whether the music player that you want to connect to is correct. Answer “Yes” to continue and connect to the music player.

Answer “No,” and the voice guide will say “Please say.” Say the number of the music player that you want to connect to.

7

NOTE

- You can connect to a music player at any time by pressing the SPEECH button and saying the number, even before all of the paired numbers and device tags of corresponding music players are read out by the system.

5. The selected music player will be connected to the Bluetooth® 2.0 interface. The voice guide will say “<device tag> selected” and then the system will return to the main menu.

Deleting a device

E00779500052

Use the following procedure to delete a paired Bluetooth® device from the Bluetooth® 2.0 interface.

1. Press the SPEECH button.
2. Say “Setup.”
3. Say “Pairing Options.”
4. The voice guide will say “Select one of the following: pair, edit, delete, or list.” Say “Delete.”

5. After the voice guide says “Please say,” the numbers of the devices and device tags of corresponding devices will be read out in order, starting with the device that has been most recently connected. After it completes reading all pairs, the voice guide will say “or all.”

Say the number of the device that you want to delete from the system.

If you want to delete all paired phones from the system, say “All.”

6. For confirmation purposes, the voice guide will say “Deleting <device tag> <number>. Is this correct?” or “Deleting all devices. Is this correct?” Answer “Yes” to delete the phone(s). Answer “No,” the system will return to Step 4.

7. The voice guide will say “Deleted,” and then the system will end the device deletion process.

NOTE

- If the device deletion process fails for some reason, the voice guide will say “Delete failed” and then the system will cancel deleting the device.

To check a paired Bluetooth® device

E00760800017

You can check a paired Bluetooth® device by following the steps below.

1. Press the SPEECH button.
2. Say “Setup.”
3. Say “Pairing Options.”
4. The voice guide will say “Select one of the following: pair, edit, delete, or list.” Say “List.”
5. The voice guide will read out device tags of corresponding devices in order, starting with the Bluetooth® device that has been most recently connected.
6. After the device tags of all paired Bluetooth® devices have been read, the system will say “End of list, would you like to start from the beginning?”

To hear the list again from the beginning, answer “Yes.”
When you are done, answer “No” to return to the main menu.

NOTE

- If you press and release the SPEECH button and say “Continue” or “Previous” while the list is being read, the system will advance or rewind the list.
Say “Continue” to proceed to the device with the next highest number or “Previous” to return to the phone with the previous number.
- You can change the device tag by pressing and releasing the SPEECH button and then saying “Edit” while the list is being read.
- You can change the phone to be connected by pressing and releasing the SPEECH button and then saying “Select phone” while the list is being read.
- You can change the music player to be connected by pressing and releasing the SPEECH button and then saying “Select music player” while the list is being read.

Changing a device tag

E00760900018

You can change the device tag of a paired cellular phone or music player.
Follow the steps below to change a device tag.

1. Press the SPEECH button.
2. Say “Setup.”
3. Say “Pairing Options.”
4. The voice guide will say “Select one of the following: pair, edit, delete, or list.” Say “Edit.”

5. The voice guide will say “Please say,” and read out the numbers of the Bluetooth® devices and device tags of corresponding devices in order, starting with the Bluetooth® that has been most recently connected.

After all paired device tags have been read, the voice guide will say “Which device, please?” Say the number of the device tag you want to change.

NOTE

- You can press and release the SPEECH button while the list is being read, and immediately say the number of the device tag you want to change.

6. The voice guide will say “New name, please.” Say the name you want to register as a new device tag.

When the confirmation function is on, the voice guide will say “<New device tag>. Is this correct?” Answer “Yes.”

Answer “No,” you can say the new device tag you want to register again.

7. The device tag is changed.

Bluetooth® 2.0 interface*

When the change is complete, the voice guide will say “New name saved” and then the system will return to the main menu.

Operating a music player connected via Bluetooth®

E00761000016

For the operation of a music player connected via Bluetooth®, refer to “To play tracks from a Bluetooth® device” on page 7-44.

7

How to make or receive hands-free calls

E00761100059

You can make or receive hands-free calls using a Bluetooth® compatible cellular phone connected to the Bluetooth® 2.0 interface. You can also use the phonebooks in the Bluetooth® 2.0 interface to make calls without dialling telephone numbers.

To make a call P.7-64

Send function P.7-65

Receiving calls P.7-65

Mute function P.7-66

Switching between hands-free mode and private mode P.7-66

For pleasant driving 7-63

Bluetooth® 2.0 interface*

NOTE

- The hands-free calls might not be operated correctly when it makes calling or receiving by operating the cellular phone directly.

To make a call

E00761200148

You can make a call in the following 3 ways using the Bluetooth® 2.0 interface:

- 7** Making a call by saying a telephone number, making a call using the Bluetooth® 2.0 interface's phonebook, and making a call by redialing.

Making a call by using the telephone number

You can make a call by saying the telephone number.

1. Press the SPEECH button.
2. Say "Dial."
3. After the voice guide says "Number please," say the telephone number.
4. The voice guide will say "Dialing <number recognized>."

The Bluetooth® 2.0 interface will then make the call.

When the confirmation function is on, the system will confirm the telephone number again. To continue with that number, answer "Yes."

To change the telephone number, answer "No." The system will say "Number please" then say the telephone number again.

NOTE

- In the case of English, the system will recognize both "zero" and "oh" (Letter "o") for the number "0."
- The Bluetooth® 2.0 interface supports numbers (0 to 9) and characters (+, # and *).
- The maximum supported telephone number length is as follows:
 - International telephone number: + and telephone numbers (to 18 digits).
 - Except for international telephone number: telephone numbers (to 19 digits).

Making a call using a phonebook

You can make calls using the vehicle phonebook or mobile phonebook of the Bluetooth® 2.0 interface.

For details on the phonebooks, refer to "Phonebook function" on page 7-66.

1. Press the SPEECH button.
2. Say "Call."

NOTE

- If you say "Call" when the vehicle phonebook and the mobile phonebook are empty, the voice guide will say "The vehicle phonebook is empty. Would you like to add a new entry now?"
Answer "Yes," and the voice guide will say "Entering the phonebook - new entry menu." You can now create data in the vehicle phonebook.
Answer "No," the system will return to the main menu.

3. After the voice guide says "Name please," say the name you want to call, from those registered in the phonebook.
4. If there is only 1 match, the system will proceed to Step 5.
If there are 2 or more matches, the voice guide will say "More than one match was found, would you like to call <returned name>." If that person is the one you want to call, answer "Yes."
Answer "No," the name of the next matching person will be uttered by the voice guide.

NOTE

- If you say "No" to all names read by the system, the voice guide will say "Name not found, returning to main menu" and the system will return to the main menu.

Bluetooth® 2.0 interface*

5. If only 1 telephone number is registered under the name you just said, the voice guide will proceed to Step 6.

If 2 or more telephone numbers are registered that match the name you just said, the voice guide will say “Would you like to call <name> at [home], [work], [mobile], or [other]?” Select the location to call.

NOTE

- If the name you selected has matching data in the vehicle phonebook but no telephone number is registered under the selected location, the voice guide will say “{home/work/mobile/other} not found for <name>. Would you like to add location or try again?” Say “Try again,” and the system will return to Step 3. Say “Add location” and you can register an additional telephone number under the selected location.
- If the name you selected has matching data in the mobile phonebook but no telephone number is registered under the selected location, the voice guide will say “{home/work/mobile/other} not found for <name>. Would you like to try again?” Answer “Yes,” and the system will return to Step 3. Answer “No,” and the call will be cancelled. Start over again from Step 1.

6. The voice guide will say “Calling <name> <location>” and then the system will dial the telephone number.

NOTE

- When the confirmation function is on, the system will check if the name and location of the receiver are correct. If the name is correct, answer “Yes.” To change the name or location to call, answer “No.” The system will return to Step 3.

Redialing

You can redial the last number called, based on the history of dialed calls in the paired cellular phone.

Use the following procedure to redial.

1. Press the SPEECH button.
2. Say “Redial.”

Send function

E00761300035

During a call, press the SPEECH button to enter voice recognition mode, then say “<numbers> SEND” to generate DTMF tones.

For example, if during a call you need to simulate the pressing of a phone button as a response to an automated system, press the

SPEECH button and speak “1 2 3 4 pound send” and the 1234# will be sent via your cellular phone.

Receiving calls

E00761601077

If an incoming phone call is received while the ignition switch or the operation mode is in ON or ACC, the audio system will be automatically turned on and switched to the incoming call, even when the audio system was originally off.

The voice guide announcement for the incoming call will be output from the left side speaker. You can change the setting so that the voice guide announcement will be output from the right side speaker. For details, refer to “To change the position of the speaker of the output sound” on page 7-33.

If the CD player or radio was playing when the incoming call was received, the audio system will mute the sound from the CD player or radio and output only the incoming call.

To receive the call, press the PICK-UP button on the steering wheel control switch.

When the call is over, the audio system will return to its previous state.

Bluetooth® 2.0 interface*

Mute function

E00760300041

At any time during a call, you can mute the vehicle microphone.

Pressing the SPEECH button and then saying “Mute” during a call will turn ON the mute function and mute the microphone.

Saying “Mute off” in the same way will turn off the mute function and cancel the mute on the microphone.

7

Switching between hands-free mode and private mode

E00761400036

The Bluetooth® 2.0 interface can switch between hands-free mode (hands-free calls) and private mode (calls using cellular phone). If you press the SPEECH button and say “Transfer call” during a hands-free call, you can stop the hands-free mode and talk in private mode.

To return to hands-free mode, press the SPEECH button again and say “Transfer call.”

Phonebook function

E00763700017

The Bluetooth® 2.0 interface has 2 types of unique phonebooks that are different from the phonebook stored in the cellular phone. They

7-66 For pleasant driving

are the vehicle phonebook and the mobile phonebook.

These phonebooks are used to register telephone numbers and make calls to desired numbers via voice recognition function.

NOTE

- Disconnecting the battery cable will not delete information registered in the phonebook.

Vehicle phonebook

E00763801406

This phonebook is used when making calls with the voice recognition function.

Up to 32 names can be registered in the vehicle phonebook per language.

Also, each entry has 4 locations associated with: home, work, mobile and other. You can register one telephone number for each location.

You can register a desired name as a name for any phonebook entry registered in the vehicle phonebook.

Names and telephone numbers can be changed later on.

The vehicle phonebook can be used with all paired cellular phones.

■ To register a telephone number in the vehicle phonebook

E00769700064

You can register a telephone number in the vehicle phonebook in the following 2 ways: Reading out a telephone number, and selecting and transferring 1 phonebook entry from the phonebook of the cellular phone.

◆ To register by reading out a telephone number

E00779600037

1. Press the SPEECH button.
2. Say “Phonebook.”
3. The voice guide will say “Select one of the following: new entry, edit number, edit name, list names, delete, erase all, or import contact.” Say “New entry.”
4. The voice guide will say “Name please.” Say your preferred name to register it.

NOTE

- If the maximum number of entries are already registered, the voice guide will say “The phonebook is full. Would you like to delete a name?” Say “Yes” if you want to delete a registered name. If you say “No,” the system will return to the main menu.

5. When the name has been registered, the voice guide will say “home, work, mobile, or other?” Say the location for which you want to register a telephone number.

NOTE

- When the confirmation function is on, the voice guide will say “<Location>. Is this correct?” Answer “Yes.”

If a telephone number has been registered for the selected location, the voice guide will say “The current number is <telephone number>, number please.”

If you do not want to change the telephone number, say “cancel” or the original number to keep it registered.

6. The voice guide will say “Number please.” Say the telephone number to register it.

NOTE

- In the case of English, the system will recognize both “zero” and “oh” (Letter “o”) for the number “0.”

7. The voice guide will repeat the telephone number you have just read, and then register the number.

When the telephone number has been registered, the voice guide will say “Number saved. Would you like to add another number for this entry?”

To add another telephone number for a new location for the current entry, answer “Yes.” The system will return to location selection in Step 5.

Answer “No” to end the registration process and return to the main menu.

NOTE

- When the confirmation function is on, after repeating the telephone number you have read, the voice guide will ask “Is this correct?” Answer “Yes.”
- Answer “No” to return to telephone number registration in step 6.

◆ To select and transfer one phonebook entry from the phonebook of the cellular phone

E00779700038

You can select 1 phonebook entry from the phonebook of the cellular phone and register it in the vehicle phonebook.

NOTE

- Transfer is not permitted unless the vehicle is parked. Before transferring, make sure that the vehicle is parked in a safe location.

NOTE

- All or part of data may not be transferred, even when the cellular phone supports Bluetooth®, depending on the compatibility of the device.
- The maximum supported telephone number length is 19 digits. Any telephone number of 20 digits or more will be truncated to the first 19 digits.
- If telephone numbers contain characters other than 0 to 9, *, # or +, these characters are deleted before the transfer.
- For the connection settings on the cellular phone side, refer to the instructions for the cellular phone.

1. Press the SPEECH button.
2. Say “Phonebook.”
3. The voice guide will say “Select one of the following: new entry, edit number, edit name, list names, delete, erase all, or import contact.” Say “Import contact.”
4. The voice guide will say “Would you like to import a single entry or all contacts?” Say “Single entry.”

The Bluetooth® 2.0 interface will become ready to receive transferred phonebook data.

Bluetooth® 2.0 interface*

NOTE

- If the maximum number of entries are already registered, the voice guide will say “The phonebook is full. Would you like to delete a name?” Say “Yes” if you want to delete a registered name. If you say “No,” the system will return to the main menu.

7

5. After the voice guide says “Ready to receive a contact from the phone. Only a home, a work, and a mobile number can be imported,” the Bluetooth® 2.0 interface will receive the phonebook data from the Bluetooth® compatible cellular phone.

6. Operate the Bluetooth® compatible cellular phone to set it up so that the phonebook entry you want to register in the vehicle phonebook can be transferred to the Bluetooth® 2.0 interface.

NOTE

- If the Bluetooth® 2.0 interface cannot recognize the Bluetooth® compatible cellular phone or the connection takes too much time, the voice guide will say “Import contact has timed out” and then the system will cancel the registration. In such case, start over again from Step 1.

NOTE

- Pressing the HANG-UP button or pressing and holding the SPEECH button will cancel the registration.

7. When the reception is complete, the voice guide will say “<Number of telephone numbers that had been registered in the import source> numbers have been imported. What name would you like to use for these numbers?” Say the name you want to register for this phonebook entry.

NOTE

- If the entered name is already used for other phonebook entry or similar to a name used for other phonebook entry, that name cannot be registered.

8. The voice guide will say “Adding <name>.”

When the confirmation function is on, the system will ask if the name is correct. Answer “Yes.”

Answer “No,” the voice guide will say “Name please.” Register a different name.

9. The voice guide will say “Numbers saved.”

10. The voice guide will say “Would you like to import another contact?”

Answer “Yes” if you want to continue with the registration. You can continue to register a new phonebook entry from Step 5.

Answer “No,” the system will return to the main menu.

■ To change the content registered in the vehicle phonebook

E00739800024

You can change or delete a name or telephone number registered in the vehicle phonebook. You can also listen to the list of names registered in the vehicle phonebook.

NOTE

- The system must have at least one entry.

◆ Editing a telephone number

1. Press the SPEECH button.

2. Say “Phonebook.”

3. The voice guide will say “Select one of the following: new entry, edit number, edit name, list names, delete, erase all, or import contact”. Say “Edit number.”

4. The voice guide will say “Please say the name of the entry you would like to edit, or say list names.” Say the name of the phonebook entry you want to edit.

Bluetooth® 2.0 interface*

 **NOTE**

- Say “List names,” and the names registered in the phonebook will be read out in order. Refer to “Vehicle phonebook: Listening to the list of registered names” on page 7-69.

5. The voice guide will say “Home, work, mobile or other?” Select and say the location where the telephone number you want to change or add is registered.

When the confirmation function is on, the system will check the target name and location again. Answer “Yes” if you want to continue with the editing.

Answer “No,” the system will return to Step 3.

6. The voice guide will say “Number, please.” Say the telephone number you want to register.

 **NOTE**

- If the telephone number is already registered in the selected location, the voice guide will say “The current number is <current number>. New number, please.” Say a new telephone number to change the current number.

7. The voice guide will repeat the telephone number.

When the confirmation function is on, the system will ask if the number is correct. Answer “Yes.”

Answer “No,” the system will return to the Step 3.

8. Once the telephone number is registered, the voice guide will say “Number saved” and then the system will return to the main menu.

 **NOTE**

- If the location where a telephone number was already registered has been overwritten with a new number, the voice guide will say “Number changed” and then the system will return to the main menu.

◆ **Editing a name**

1. Press the SPEECH button.
2. Say “Phonebook.”
3. The voice guide will say “Select one of the following: new entry, edit number, edit name, list names, delete, erase all, or import contact.” Say “Edit name.”
4. The voice guide will say “Please say the name of the entry you would like to edit, or say list names.” Say the name you want to edit.

 **NOTE**

- Say “List names,” and the names registered in the phonebook are read out in order. Refer to “Vehicle phonebook: Listening to the list of registered names” on page 7-69.

5. The voice guide will say “Changing <name>.”

When the confirmation function is on, the system will check if the name is correct.

Answer “Yes” if you want to continue with the editing based on this information. Answer “No,” the system will return to Step 4.

6. The voice guide will say “Name please.” Say the new name you want to register.

7. The registered name will be changed. When the change is complete, the system will return to the main menu.

◆ **Listening to the list of registered names**

E00739900025

1. Press the SPEECH button.
2. Say “Phonebook.”
3. The voice guide will say “Select one of the following: new entry, edit number, edit name, list names, delete, erase all, or import contact.” Say “List names.”
4. Bluetooth® 2.0 interface will read out the entries in the phonebook in order.

Bluetooth® 2.0 interface*

- When the voice guide is done reading the list, it will say “End of list, would you like to start from the beginning?” When you want to check the list again from the beginning, answer “Yes.” When you are done, answer “No” to return to the previous or main menu.

 **NOTE**

- You can call, edit or delete a name that is being read out. Press the SPEECH button and say “Call” to call the name, “Edit name” to edit it, or “Delete” to delete it. The system will beep and then execute your command.
- If you press the SPEECH button and say “Continue” or “Previous” while the list is being read, the system will advance or rewind the list. Say “Continue” to proceed to the next entry or “Previous” to return to the previous entry.

7

◆ Deleting a telephone number

E00740000026

- Press the SPEECH button.
- Say “Phonebook.”
- The voice guide will say “Select one of the following: new entry, edit number, edit name, list names, delete, erase all, or import contact.” Say “Delete.”

- The voice guide will say “Please say the name of the entry you would like to delete, or say list names.” Say the name of the phonebook entry in which the telephone number you want to delete is registered.

 **NOTE**

- Say “List names,” and the names registered in the phonebook are read out in order. Refer to “Vehicle phonebook: Listening to the list of registered names” on page 7-69.

- If only one telephone number is registered in the selected phonebook entry, the voice guide will say “Deleting <name> <location>.”

If multiple telephone numbers are registered in the selected phonebook entry, the voice guide will say “Would you like to delete [home], [work], [mobile], [other], or all?”

Select the location to delete, and the voice guide will say “Deleting <name> <location>.”

 **NOTE**

- To delete the telephone numbers from all locations, say “All.”

- The system will ask if you really want to delete the selected telephone number(s) to go ahead with the deletion, answer “Yes.” Answer “No,” the system will cancel deleting the telephone number(s) and then return to Step 4.
- When the telephone number deletion is complete, the voice guide will say “<name> <location> deleted” and then the system will return to the main menu. If all locations are deleted, the system will say “<name> and all locations deleted” and the name will be removed from the phonebook. If numbers still remain under the entry, the name will retain the other associated numbers.

■ Erasing the phonebook

E00740100027

You can delete all registered information from the vehicle phonebook.

- Press the SPEECH button.
- Say “Phonebook.”
- The voice guide will say “Select one of the following: new entry, edit number, edit name, list names, delete, erase all, or import contact.” Say “Erase all.”
- For confirmation purposes, the voice guide will ask “Are you sure you want to erase everything from your hands-free system phonebook?” Answer “Yes.”

Bluetooth® 2.0 interface*

Answer “No” to cancel the deletion of all registered information in the phonebook and return to the main menu.

5. The voice guide will say “You are about to delete everything from your hands-free system phonebook. Do you want to continue?” Answer “Yes” to continue.

Answer “No” to cancel the deletion of all registered information in the phonebook and return to the main menu.

6. The voice guide will say “Please wait, erasing the hands-free system phonebook” and then the system will delete all data in the phonebook.

When the deletion is complete, the voice guide will say “Hands-free system phonebook erased” and then the system will return to the main menu.

Mobile phonebook

E00763900080

All entries in the phonebook stored in the cellular phone can be transferred in a batch and registered in the mobile phonebook.

Up to 7 mobile phonebooks, each containing up to 1,000 names, can be registered.

The Bluetooth® 2.0 interface automatically converts from text to voice the names registered in the transferred phonebook entries, and creates names.

NOTE

- Only the mobile phonebook transferred from the connected cellular phone can be used with that cellular phone.
- You cannot change the names and telephone numbers in the phonebook entries registered in the mobile phonebook. You cannot select and delete specific phonebook entries, either. To change or delete any of the above, change the applicable information in the source phonebook of the cellular phone and then transfer the phonebook again.

To import a devices phonebook

Follow the steps below to transfer to the mobile phonebook the phonebook stored in the cellular phone.

NOTE

- Transfer should be completed while the vehicle is parked. Before transferring, make sure that the vehicle is parked in a safe location.
- The already stored phonebook in the mobile phonebook is overwritten by the stored phonebook in the cellular phone.
- All or part of data may not be transferred, even when the cellular phone supports Bluetooth®, depending on the compatibility of the device.
- Only a home, a work, and a mobile number can be imported.

NOTE

- The maximum supported telephone number length is 19 digits. Any telephone number of 20 digits or more will be truncated to the first 19 digits.
- If telephone numbers contain characters other than 0 to 9, *, # or +, these characters are deleted before the transfer.
- For the connection settings on the cellular phone side, refer to the instructions for the cellular phone.

7

1. Press the SPEECH button.
2. Say “Phonebook.”
3. The voice guide will say “Select one of the following: new entry, edit number, edit name, list names, delete, erase all, or import contact.” Say “Import contact.”
4. The voice guide will say “Would you like to import a single entry or all contacts?” Say “All contacts.”
5. The voice guide will say “Importing the contact list from the mobile phonebook. This may take several minutes to complete. Would you like to continue?” Answer “Yes,” transferring to the mobile phonebook the phonebook stored in the cellular phone will start. Answer “No,” the system will return to the main menu.

Bluetooth® 2.0 interface*

NOTE

- The transfer may take some time to complete depending on the number of contacts.
- If the Bluetooth® 2.0 interface could not be connected to the Bluetooth® compatible cellular phone, the voice guide will say “Unable to transfer contact list from phone” and then the system will return to the main menu.
- If you press the HANG-UP button or press and hold the SPEECH button during the data transfer, the transfer will be cancelled and the system will return to the main menu.
- If an error occurs during the data transfer, all transfer will be cancelled and the voice guide will say “Unable to complete the phonebook import” and then the system will return to the main menu.
- If there are no contacts in the phonebook, the voice guide will say “There are no contacts on the connected phone.”

7

6. When the transfer is complete, the voice guide will say “Import complete” and then the system will return to the main menu.

7-72 For pleasant driving

USB input terminal*

Enrollment commands

E00732401640

Phrase	English	French	Spanish	Italian	German	Dutch	Portuguese	Russian
1	0123456789	0123456789	0123456789	0123456789	0123456789	0123456789	0123456789	0123456789
2	888 555 1212	888 555 1212	888 555 1212	888 555 1212	888 555 1212	888 555 1212	888 555 1212	888 555 1212
3	Call	Appeler	Llamar	Chiama	Anrufen	Bellen	Ligar	Вызов
4	Dial	Composer	Marcar	Componi	Wählen	Nummer keuze	Marcar	Набор
5	Setup	Configurer	Configuración	Configura	Einrichtung	Setup	Configurar	Настройка
6	Cancel	Annuler	Cancelar	Annulla	Abbrechen	Annuleren	Cancelar	Отмена
7	Continue	Continuer	Continuar	Continua	Weiter	Doorgaan	Continuar	Продолжить
8	Help	Aide	Ayuda	Aiuto	Hilfe	Help	Ajuda	Справка

7

USB input terminal*

E00761902266

You can connect your USB memory device, iPod* or smartphone to play music files stored in the connected device.

*: "iPod" is a registered trademark of Apple Inc. in the United States and other countries.

This section explains how to connect and remove a USB memory device, iPod or smartphone.

See the following section for details on how to play music files.

For vehicles equipped with AM/FM electronic tuning radio with CD player

Refer to "To play tracks from USB device" on page 7-34.

Refer to "To play iPod tracks via voice operation" on page 7-37.

For vehicles equipped with Smartphone-link Display Audio (SDA)

Refer to the separate owner's manual.

WARNING

- Do not perform to connect/disconnect the USB memory device, iPod or smartphone while driving. This can be dangerous. Be sure to perform before driving.

USB input terminal*

How to connect a USB memory device

E00762002163

To connect

1. Connect a commercially available USB connector cable (A) to the USB memory device (B).

7

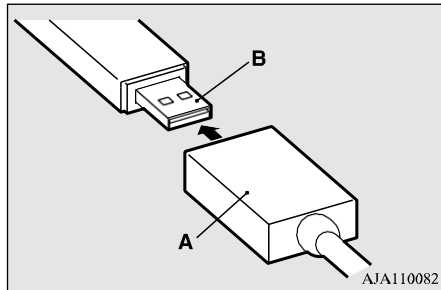

AJA110082

2. Open the cover (C) and connect the opposite end of the USB connector cable.

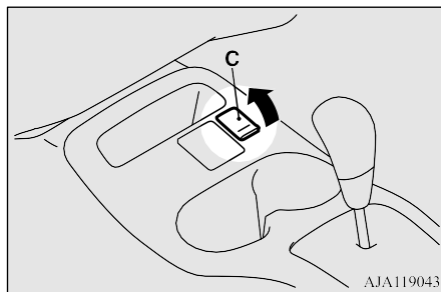

AJA119043

7-74 For pleasant driving

NOTE

- Do not connect the USB memory device to the USB input terminal directly. The USB memory device may be damaged.

3. To disconnect the USB connector cable, perform the installation steps in reverse.

How to connect an iPod or smartphone

E00762102278

To connect

1. Connect the connector cable to the iPod or the USB connector cable to the smartphone.

NOTE

- When you connect the iPod, use a genuine connector cable from Apple Inc.

2. Open the cover (A) and connect the opposite end of the connector cable or the USB connector cable.

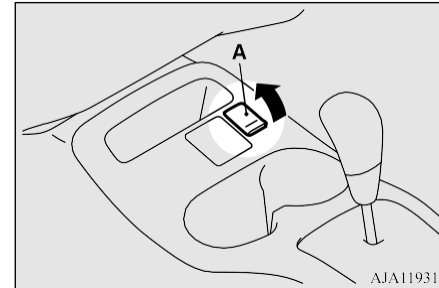

AJA119317

3. To disconnect the connector cable or the USB connector cable, perform the installation steps in reverse.

Types of connectable devices and supported file specifications

E00762201836

For vehicles equipped with Smartphone-link Display Audio (SDA)

Refer to the separate owner's manual.

For vehicles equipped with AM/FM electronic tuning radio with CD player

Refer to the following sections.

USB input terminal*

Device types

E00762301938

Devices of the following types can be connected.

Model name	Condition
USB memory device	Storage capacity of 256 Mbytes or more (File System is FAT16/32)
iPod*	fifth generation F/W Ver.1.3 or later
iPod classic*	80GB/180GB F/W Ver.1.1.2 or later
	120GB F/W Ver.2.0.1 or later
	160GB (late 2009) F/W Ver.2.0.4 or later

Model name	Condition
iPod nano*	first generation F/W Ver.1.3.1 or later
	second generation F/W Ver.1.1.3 or later
	third generation F/W Ver.1.1.3 or later
	fourth generation F/W Ver.1.0.4 or later
	fifth generation F/W Ver.1.0.2 or later
	sixth generation F/W Ver.1.0 or later
iPod touch*	first generation F/W Ver.3.1.3 or later
	second generation F/W Ver.4.2.1 or later
	third generation F/W Ver.4.3.1 or later
	fourth generation F/W Ver.4.3.1 or later

Model name	Condition
iPhone*	iPhone F/W Ver.3.1.3 or later
	iPhone 3G F/W Ver.4.2.1 or later
	iPhone 3GS F/W Ver.4.3.1 or later
	iPhone 4 F/W Ver.4.3.1 or later
	iPhone 4S F/W Ver.5.0.1 or later
Models other than USB memory devices and iPods	Digital audio player supporting mass storage class

*: “iPod”, “iPod classic”, “iPod nano”, “iPod touch” and “iPhone” are registered trademarks of Apple Inc. in the United States and other countries.

On vehicles equipped with the Bluetooth® 2.0 interface, for connectable device types for “iPod”, “iPod classic”, “iPod nano”, “iPod touch” and smartphone, access the MITSUBISHI MOTORS website.

Please read and agree to the “Warning about Links to the Web Sites of Other Companies”. The websites mentioned above may connect

For pleasant driving 7-75

Sun visors

you to websites other than the MITSUBISHI MOTORS websites.

<https://www.mitsubishi-motors.com/en/products/index.html>

You may not be able to use above website depending on your area.

NOTE

- Depending on the type of the USB memory device or other devices connected, the connected device may not function properly or the available functions may be limited.
- It is recommended to use an iPod with firmware updated to the latest version.
- You can charge your iPod by connecting it to the USB input terminal when the ignition switch or the operation mode is in ON or ACC.
- Do not keep your USB memory device, iPod or smartphone in your vehicle.
- It is recommended that you back up the files in case of data damage.
- Do not connect to the USB input terminal any device (hard disk, card reader, memory reader, etc.) other than the connectable devices specified in the previous section. The device and/or data may be damaged. If any of these devices was connected by mistake, remove it after turning the ignition switch to the "LOCK" position or putting the operation mode in OFF.

7

7-76 For pleasant driving

File specifications

E00762401186

You can play music files of the following specifications that are saved in a USB memory device or other devices supporting mass storage class. When you connect your iPod, playable file specifications depend on the connected iPod.

Item	Condition
File format	MP3, WMA, AAC, WAV*
Maximum number of levels (including the root)	Level 8
Number of folders	700
Number of files	65,535

*: Vehicles equipped with the Bluetooth® 2.0 interface

SUN VISORS

E00711202844

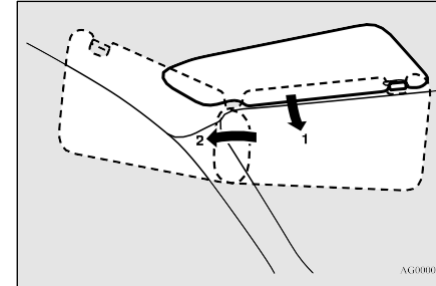

- 1- To eliminate front glare
- 2- To eliminate side glare

Vanity mirror

A vanity mirror is fitted to the back of the sun visor.

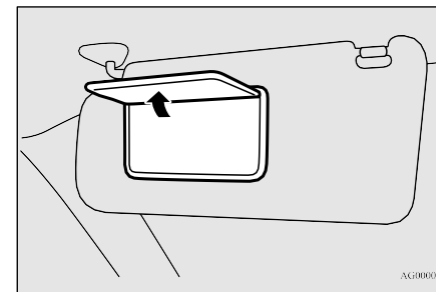

Ticket holder

The holder (A) is located on the back of the sun visor.

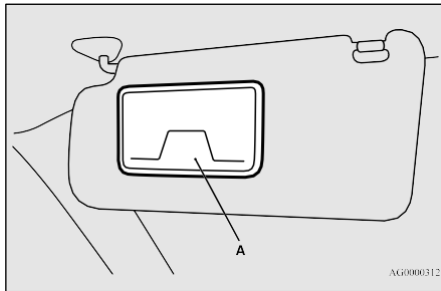

CAUTION

- Do not leave plastic cards in the ticket holder. Because the inside of the vehicle will become hot if the vehicle is parked in strong sunlight, the cards could deform or crack.

Ashtray*

E00711402413

CAUTION

- Put out matches and cigarettes before they are placed in the ashtray.

CAUTION

- Don't put papers and other things that burn into your ashtrays. If you do, cigarettes or other smoking materials could set them on fire, causing damage.
- Always close the ashtray. If left open, other cigarette butts in the ashtray may be rekindled.

To use the ashtray, open the lid.

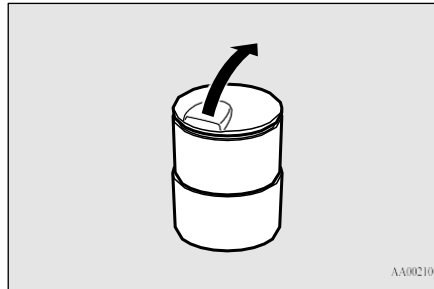

Ashtray*

Mounting position for moveable ashtray

The moveable ashtray can be fitted at the indicated position (passenger's side).

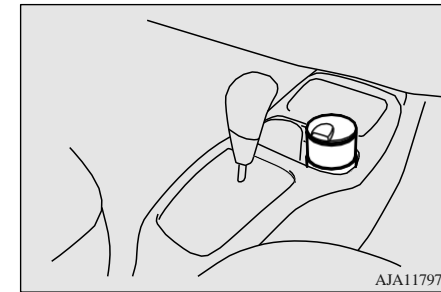

7

Cigarette lighter*

Cigarette lighter*

E00711502889

The cigarette lighter can be used while the ignition switch or the operation mode is in ON or ACC.

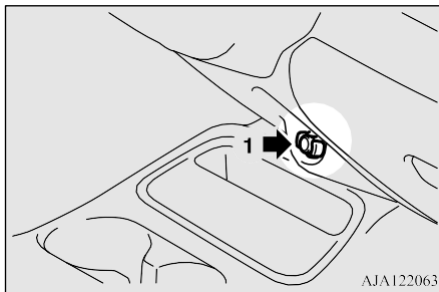

1- Push all the way in.

The cigarette lighter will automatically return to its original position with a “click” when ready. Pull it out for use.

After use, insert the cigarette lighter to its original position in the socket.

NOTE

- Do not leave the cigarette lighter removed from its socket, because the socket might become clogged by foreign material and be short-circuited.

CAUTION

- Do not use the cigarette lighter while driving. This is distracting and could cause an accident.
- Do not touch the heating element or the cigarette lighter housing, hold the knob only to prevent burns.
- Do not allow children to operate or play with the cigarette lighter as burns may occur.
- Something is wrong with the cigarette lighter if it does not pop back out within approximately 30 seconds of being pushed in. Pull it out and have the problem corrected at an authorised MITSUBISHI MOTORS dealer.
- Do not use any electric appliance that is not approved by MITSUBISHI MOTORS. Doing so could damage the socket. If you used the cigarette lighter after damaging the socket, the cigarette lighter might pop out or fail to come out after being pushed in.
- When the cigarette lighter socket is used as a power source for an electric appliance, be sure that the electric appliance operates at 12 V and has an electric capacity of 120 W or less. In addition, long use of the electric appliance without running the engine may run down the battery.

Accessory socket*

E00711602750

The accessory socket can be used while the ignition switch or the operation mode is in ON or ACC.

To use a plug-in type accessory, open the cap, and insert the plug in the accessory socket.

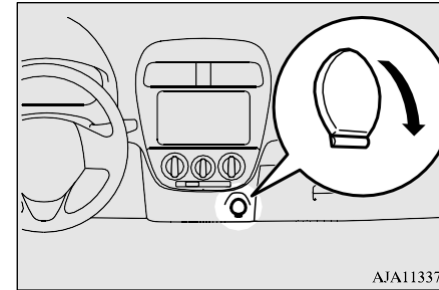

CAUTION

- Be sure to use a “plug-in” type accessory operating at 12 V and at 120 W or less.
- Long use of the electric appliance without running the engine may run down the battery.
- When the accessory socket is not in use, be sure to close the cap, because the socket might become clogged by foreign material and be short-circuited.

Interior lamps

Interior lamps

E00712002331

NOTE

- If you leave the lamp on without running the engine, you will run down the battery. Before you leave the vehicle, make sure that the lamp is off.

Room lamp

E00712601428

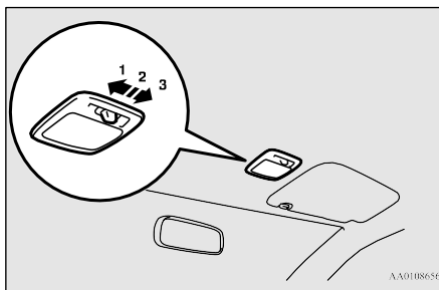

1- (OFF)

The lamp illuminates regardless of whether a door is open or closed.

2- (ON)

Delayed off function

[Vehicles without central door locks system]

The lamp illuminates when a door is opened. It goes off about 7 seconds after all doors are closed.

However, the lamp goes off immediately when the ignition switch is turned to the “ON” position with all doors closed.

[Vehicles with central door locks system] The lamp illuminates when a door is opened. It goes off about 15 seconds after the door is closed.

However, the lamp goes off immediately with all doors closed in the following cases:

- When the ignition switch is turned to the “ON” position or the operation mode is put in ON.
- When the central door lock function is used to lock the vehicle.
- When the keyless entry key or the keyless operation key is used to lock the vehicle.
- If the vehicle is equipped with the keyless operation system, when the keyless operation function is used to lock the vehicle.

Auto cut-out function

If the lamp is left switched on with the ignition switch is in the “LOCK” or “ACC” position or the operation mode is in OFF or ACC, and a door is opened, it goes off automatically after approximately 30 minutes.

The lamp will illuminate again after it automatically goes off in the following cases:

- When the ignition switch is turned to the “ON” position or the operation mode is put in ON.
- When the keyless entry system or the keyless operation system is operated.
- When all doors are closed.

NOTE

- When the key was used to start the engine, if the key is removed while the doors are closed, the lamp is illuminated and after a few seconds it goes off.
- When the keyless operation function was used to start the engine, if the operation mode is put in OFF while the doors are closed, the lamp illuminates and after about 15 seconds it goes off. (if so equipped)
- The time until the lamp goes off (delayed off) can be adjusted. Please consult an authorised MITSUBISHI MOTORS dealer.
- The auto cut-out function cannot be operated when the room lamp switch is in the “OFF” position. Also, this function can be deactivated. For details, please consult an authorised MITSUBISHI MOTORS dealer.

3- (DELAYED OFF)

7

Storage spaces

The lamp goes off regardless of whether a door is open or closed.

Storage spaces

E00713101895

CAUTION

- Never leave lighters, canned carbonated beverage, and spectacles in the cabin when parking the vehicle in hot sunshine. The cabin will become extremely hot, so lighters and other flammable items may catch fire and unopened drink cans may rupture. Also, spectacles with plastic lenses or materials could deform or crack.
- Keep the lids on storage spaces closed while driving the vehicle. A lid or the contents of a storage space could otherwise cause injuries.

7

Glove box

E00717603049

To open, pull the lever (A).

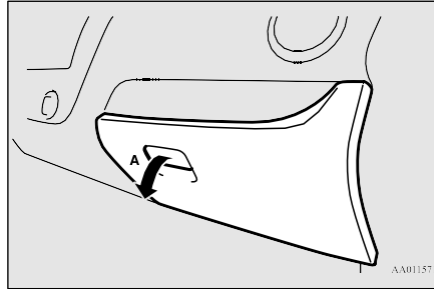

AA0115717

Cup holder

E00714502499

WARNING

- Do not spray water or spill beverages inside the vehicle. If the switches, wires, or electrical components become wet, they could malfunction or cause a vehicle fire. If you accidentally spill a beverage, wipe up as much liquid as possible and immediately consult an authorised MITSUBISHI MOTORS dealer.

CAUTION

- Do not drink beverages while driving. This is distracting and could cause an accident.

NOTE

- Plastic bottles may sometimes not fit securely depending on the shape of the bottle. Plastic bottles could fall if driving is done while a plastic bottle is not securely placed, so check that plastic bottles are placed securely or use the bottle holder.

For the front seat

The cup holder is located in front of the floor console.

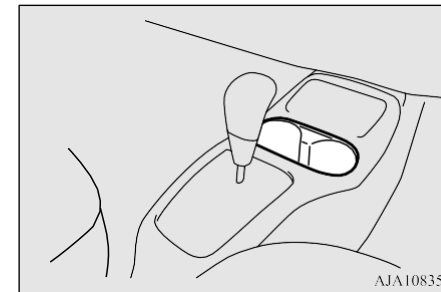

AJA108359

For the rear seat

E00718901191

Type 1

The cup holder is located behind the parking brake lever.

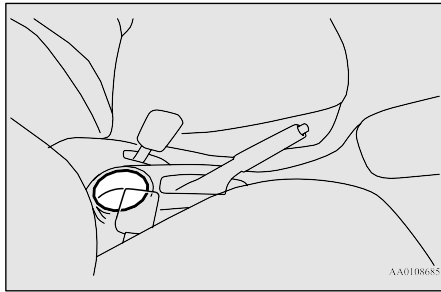

Type 2*

In order to use the cup holder, allow the armrest (A) to drop down.

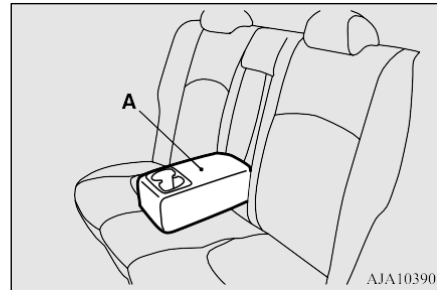

Bottle holder

E00718201598

WARNING

- Do not spray water or spill beverages inside the vehicle. If the switches, wires, or electrical components become wet, they could malfunction or cause a vehicle fire. If you accidentally spill a beverage, wipe up as much liquid as possible and immediately consult an authorised MITSUBISHI MOTORS dealer.

Bottle holder

CAUTION

- Do not drink beverages while driving. This is distracting and could cause an accident.
- Drinks could be spilled by the vibration and jolts while driving. If the spilt drink is very hot, you could be burnt.

There are bottle holders located on the front doors.

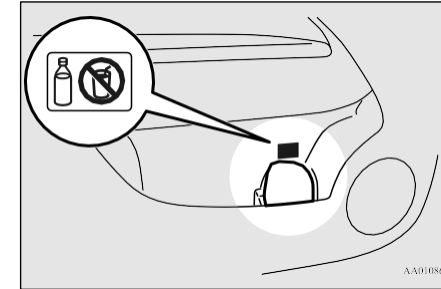

7

NOTE

- Do not store cup or drink can in the bottle holder.
- Tightly close the cap on drink bottles before storing them.
- Some bottles may be too big or the wrong shape to fit in the holder.

Convenient hook

Convenient hook

E00732901225

Light items of luggage can be hung from the hook.

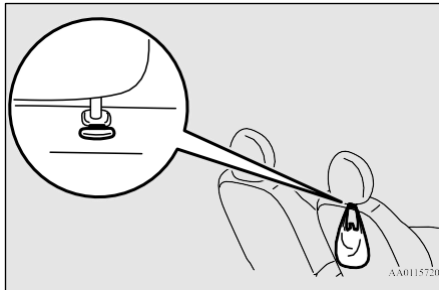

NOTE

- Do not hang heavy luggage (more than about 4 kg) on the hook. Doing so could cause damage to the hook.

Assist grip

E00732801354

The grip is to support the body by hand while seated in the vehicle.

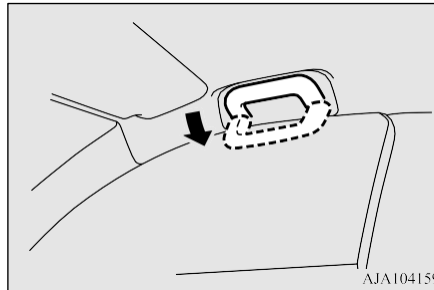

CAUTION

- Do not use the assist grip when getting into or out of the vehicle. The assist grip could detach causing you to fall.

For emergencies

If the vehicle breaks down	8-2
If the operation mode cannot be changed to OFF (vehicles equipped with the keyless operation system)	8-2
Emergency starting	8-2
Engine overheating	8-4
Tools and jack	8-5
How to change a tyre	8-6
Towing	8-13
Operation under adverse driving conditions	8-16

If the vehicle breaks down

If the vehicle breaks down

E00800101137

If the vehicle breaks down on the road, move it to the shoulder and use the hazard warning flashers and/or the warning triangle etc. Refer to “Hazard warning flasher switch” on page 5-22.

If the engine stops/fails

Vehicle operation and control are affected if the engine stops. Before moving the vehicle to a safe area, be aware of the following:

- The brake booster becomes inoperative and the pedal effort will increase. Press down the brake pedal harder than usual.
- Since the power steering system is no longer operative, the steering wheel feels heavy when turning it.

If the operation mode cannot be changed to OFF (vehicles equipped with the keyless operation system)

E00804900341

If the operation mode cannot be changed to OFF, perform the following procedure.

8-2 For emergencies

1. Move the selector lever to the “P” (PARK) position, and then change the operation mode to OFF (For vehicles with CVT).
2. One of the other causes could be low battery voltage. If this occurs, the keyless entry system, the keyless operation function and the steering wheel lock will also not operate. Contact an authorised MITSUBISHI MOTORS dealer.

Emergency starting

E00800504594

If the engine cannot be started because the battery is weak or dead, the battery from another vehicle can be used with jumper cables to start the engine.

WARNING

- To start the engine by use of jumper cables from another vehicle, perform the correct procedures according to the instruction below. Incorrect procedures could result in a fire or explosion or damage to the vehicles.
- Keep sparks, cigarettes and flames away from the battery because the battery may produce an explosion.

CAUTION

- Do not attempt to start the engine by pulling or pushing the vehicle. It could damage your vehicle.
- Check the other vehicle. It must have a 12-volt battery. If the other system isn't 12-volt, shorting can damage both vehicles.
- Use the proper cables suitable for the battery size to prevent overheating of the cables.
- Check the jumper cables for damage and corrosion before use.
- Always wear protective eye goggles when working near the battery.
- Keep the battery out of the reach of children.

1. Get the vehicles close enough so the jumper cables can reach, but be sure the vehicles aren't touching each other.
2. Turn off all lamps, heater and other electrical loads.
3. Set the parking brake firmly on each vehicle. Put an A/T or CVT in “P” (PARK) or a M/T in “N” (Neutral). Stop the engine.

WARNING

- Turn off the ignition on both vehicles beforehand. Make sure that the cables or your clothes cannot be caught by the fan or drive belt. Personal injury could result.

Emergency starting

4. Make sure battery electrolyte is at the proper level.
Refer to “Battery” on page 10-8.

⚠ WARNING

- If electrolyte fluid is not visible, or appears to be frozen, Do Not Attempt Jump Starting!

A battery might rupture or explode if the temperature is below the freezing point or if it is not filled to the proper level.

- Electrolyte is corrosive diluted sulphuric acid.

If electrolyte (battery acid) comes into contact with your hands, eyes, clothes or the painted surface of your vehicle, it should be thoroughly flushed with water. If electrolyte gets in your eyes, flush them with water immediately and thoroughly, and get prompt medical attention.

5. Connect one end of one jumper cable ① to the positive (+) terminal of the discharged battery (A), and the other end ② to the positive (+) terminal of the booster battery (B).
Connect one end of the other jumper cable ③ to the negative (-) terminal of the booster battery, and the other end ④ to the designated ground location of the vehicle with the discharged battery at the point farthest from the battery.

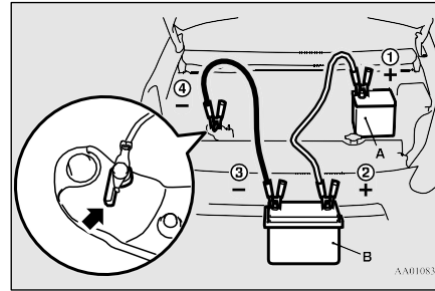

⚠ WARNING

- Make sure that the connection ④ is made to the appointed position (shown in the illustration). If the connection is made directly to the negative side of the battery, the inflammable gases generated from the battery might catch fire and explode.
- When connecting the jumper cable, do not connect the positive (+) cable to the negative (-) terminal. Otherwise sparks might cause explosion of the battery.

⚠ CAUTION

- Use care not to get the jumper cable caught in the cooling fan or other rotating part in the engine compartment.

6. Start the engine in the vehicle which has the booster battery, let the engine idle a few minutes, then start the engine in the vehicle with the discharged battery.

⚠ CAUTION

- Keep the engine of the vehicle giving assistance running.

📖 NOTE

- For vehicles equipped with the Auto Stop & Go (AS&G) system, press the “Auto Stop & Go (AS&G) OFF” switch to deactivate the Auto Stop & Go (AS&G) system and prevent the engine from automatically stopping before the battery is sufficiently charged. Refer to “To deactivate” on page 6-25.

7. After the engine is started, disconnect the cables in the reverse order and keep the engine running for several minutes.

📖 NOTE

- On a vehicle with an anti-lock brake system, if the vehicle is put in motion without fully charging the battery, it might cause the loss of smooth engine operation and the anti-lock brake warning lamp to illuminate. Refer to “Anti-lock brake system (ABS)” on page 6-35.

Engine overheating

Engine overheating

E00800604351

If the high coolant temperature warning lamp illuminates during the engine is running, the engine may be overheating.

If this occurs, take the following corrective measures:

1. Stop the vehicle in a safe place.
2. Check whether steam is coming from the engine compartment.

8

[If steam does not come from the engine compartment]

With the engine still running, raise the bonnet to ventilate the engine compartment.

NOTE

- For vehicles equipped with the Auto Stop & Go (AS&G) system, press the “Auto Stop & Go (AS&G) OFF” switch to deactivate the Auto Stop & Go (AS&G) system before stopping the vehicle. Refer to “To deactivate” on page 6-25.

[If steam is coming from the engine compartment]

Stop the engine, and when the steam stops, raise the bonnet to ventilate the engine compartment. Restart the engine.

8-4 For emergencies

WARNING

- Do not open the bonnet while steam is coming from the engine compartment. It could cause steam or hot water to spurt out, causing burns. Hot water could spurt out even when there is no steam coming out, and some parts will be very hot. Be very careful when opening the bonnet.
- Be careful of hot steam, which could be blowing off the reserve tank cap.
- Do not attempt to remove the radiator cap while the engine is hot.

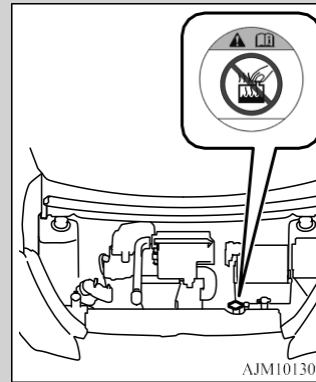

3. Confirm that the cooling fan (A) is turning.

[If the cooling fan is turning]

After the high coolant temperature warning lamp has gone off, stop the engine.

[If the cooling fan is not turning]

Stop the engine immediately and contact an authorised MITSUBISHI MOTORS dealer for assistance.

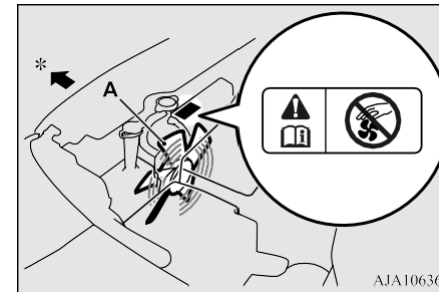

*: Front of the vehicle

WARNING

- Be careful not to get your hands or clothes caught in the cooling fan.

Tools and jack

4. Check the coolant level in the reserve tank (B).

Add coolant to the radiator and/or reserve tank if necessary. (Refer to the “Maintenance” section.)

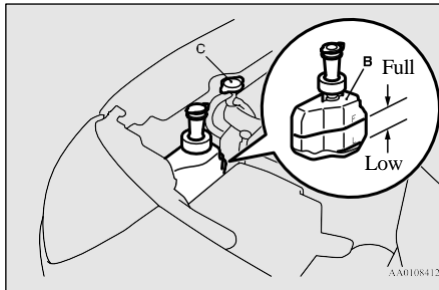

⚠ WARNING

- If there is none, make sure that the engine has cooled down before removing the radiator cap (C), because hot steam or boiling water otherwise will gush from the filler port and may scald you.

⚠ CAUTION

- Do not add coolant while the engine is hot. Suddenly adding cold coolant could damage the engine. Wait for the engine to cool down, then add coolant a little at a time.

5. Examine the radiator hoses for coolant leakage and the drive belt for looseness or damage.

If there is anything wrong with the cooling system or drive belt, have the problem corrected at an authorised MITSUBISHI MOTORS dealer.

Tools and jack

E00800902536

Storage

The tools are stored beneath the luggage floor board of the luggage compartment.

The jack is stored under the front left side seat.

The storage location of the tools and jack should be remembered in case of an emergency.

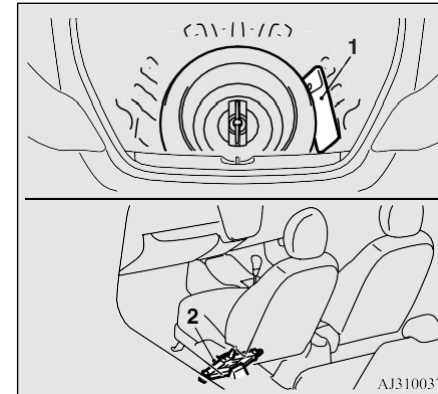

1- Tools

2- Jack

8

For emergencies

8-5

How to change a tyre

Tools

E00801900685

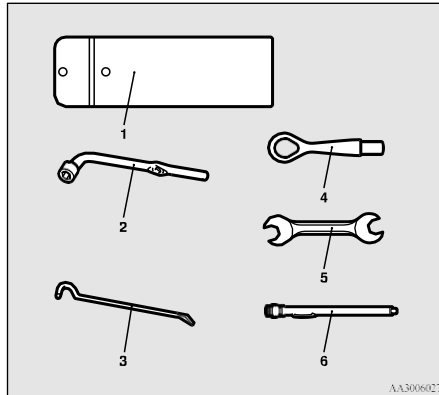

AA3006027

- 1- Tool case
- 2- Wheel nut wrench
- 3- Jack bar
- 4- Towing hook
- 5- Spanner*
- 6- Tyre inflation pressure gauge*
(Refer to “Tyre inflation pressure gauge” on page 10-11.)

Jack

E00802001592

Before removing or storing the jack, move the front left side seat fully forward to access the jack from the rear seat area.

8-6 For emergencies

(Refer to “Front seat” on page 4-2.)

CAUTION

- Never access, remove or store the jack from the front of the seat. Doing so could damage electrical wires under the seat.

To remove

Turn the shaft end of the jack in the direction (1) until the jack fully retracts and remove the jack from the holder (A).

To store

Put the jack in the holder (A) and turn the shaft end of the jack in the direction (2) by hand until the jack is firmly secured.

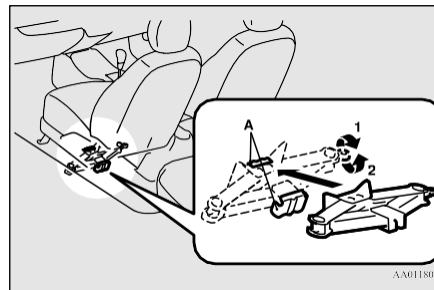

AA0118008

WARNING

- After storing the jack in place, make sure the jack is securely fixed in the holder. If the jack is not fixed securely, it may move and hit an occupant in an accident resulting in serious injury or death.

How to change a tyre

E00801203937

Before changing a tyre, first stop your vehicle in a safe, flat location.

1. Park the vehicle on level and stable ground, free of loose pebbles, etc.
2. Set the parking brake firmly.
3. On vehicles with M/T, stop the engine and move the gearshift lever to the “R” (Reverse) position.
On vehicles with CVT, move the selector lever to the “P” (PARK) position and stop the engine.
4. Turn on the hazard flashers and set up a warning triangle, flashing signal lamp, etc., at an adequate distance from the vehicle, and have all your passengers leave the vehicle.
5. To prevent the vehicle from rolling when jacking up the vehicle, place chocks or blocks (A) at the tyre that is diagonally opposite from the tyre (B) you are changing.

How to change a tyre

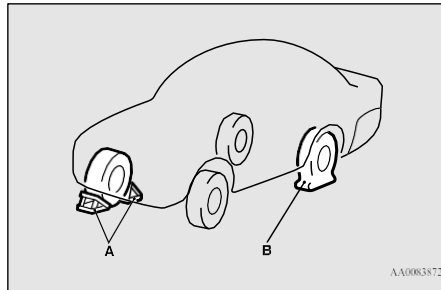

AA0063872

⚠ WARNING

- Be sure to apply chocks or blocks to the correct tyre when jacking up the vehicle. If the vehicle moves while jacked up, the jack could slip out of position, leading to an accident.

📖 NOTE

- The chocks shown in the illustration do not come with your vehicle. It is recommended that you keep ones in the vehicle for use if needed.
- If chocks are not available, use stones or any other objects that are large enough to hold the wheel in position.

- Get the jack, bar and wheel nut wrench ready.
Refer to “Tools and jack” on page 8-5.

Spare wheel information

E00803601696

The spare wheel is stored beneath the luggage floor board of the luggage compartment. Check the air pressure of the spare tyre frequently and make sure it is ready for emergency use at any time.

Maintaining the spare wheel at the highest specified air pressure will ensure that it can always be used under any conditions (city/high-speed driving, varying load weight, etc.).

⚠ CAUTION

- The pressure should be periodically checked and maintained at the specified pressure while the tyre is stowed. Driving with an insufficient tyre pressure can lead to an accident. If you have no choice but to drive with an insufficient tyre pressure, keep your speed down and inflate the tyre to the correct pressure as soon as possible. (Refer to “Tyre inflation pressures” on page 10-10.)

Compact spare wheel*

The compact spare wheel is designed to save space in the luggage compartment and its

lighter weight makes it easier to use if a flat tyre occurs.

⚠ CAUTION

- The compact spare wheel is for temporary use only and should be removed as soon as the original wheel can be repaired or replaced.
- The vehicle must not be driven at speeds in excess of 80 km/h while using the compact spare wheel.
- The compact spare tyre is not as good as a standard tyre in controllability and stability. When the compact spare tyre is used, avoid quick starts, sudden braking and sharp steering.
- The compact spare wheel is specifically designed for your vehicle and it should not be used on any other vehicle.
- [Vehicles without anti-lock brake system] Do not use the compact spare wheel on a front wheel.
If a front tyre becomes flat, first replace a rear wheel with the compact spare wheel and then use the removed rear wheel to replace the flat front wheel.
Using the compact spare wheel on a front wheel will make the front wheel slipping when braking, resulting in possible the stopping distance is extended.

How to change a tyre

⚠ CAUTION

- Do not use tyre chain with your compact spare wheel. Because of the smaller tyre size, a tyre chain will not fit properly. This could cause damage to the wheel and result in loss of the chain.

If a front tyre becomes flat when using tyre chains, first replace a rear wheel with the compact spare wheel and then use the removed rear wheel to replace the flat front wheel so that you can continue to use the chains.

8

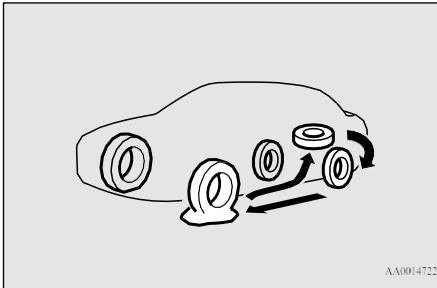

⚠ CAUTION

- Upon installation of the compact spare wheel, the ground clearance is reduced as the tyre is smaller in diameter than the standard tyre. When passing over the projections on the road, use care not to damage the vehicle's undercarriage.
- Do not install more than one compact spare wheel at the same time.

8-8 For emergencies

To remove the spare tyre

E00803501536

1. Lift up the luggage floor board.
2. To remove the spare tyre, remove the installation clamp (A) by turning it anti-clockwise.

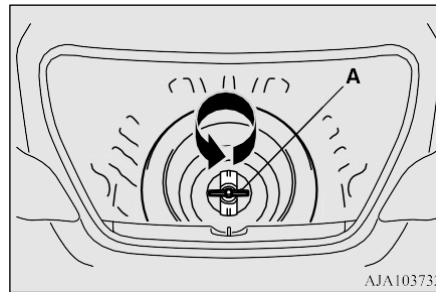

NOTE

- Put the spare wheel under the vehicle body near the jack. This makes it safer if the jack slips out of position.

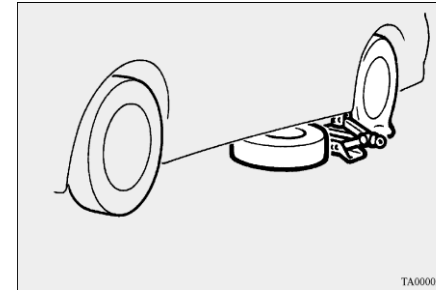

To change a tyre

E00803202862

1. On vehicles with wheel covers, first remove the covers (refer to "Wheel covers" on page 8-12). Then loosen the wheel nuts a quarter turn with the wheel nut wrench. Do not remove the wheel nuts yet.

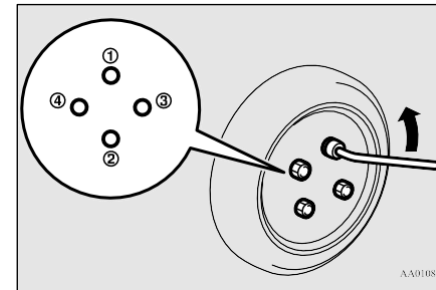

2. Place the jack under one of the jacking points (A) shown in the illustration. Use the jacking point closest to the tyre you wish to change.

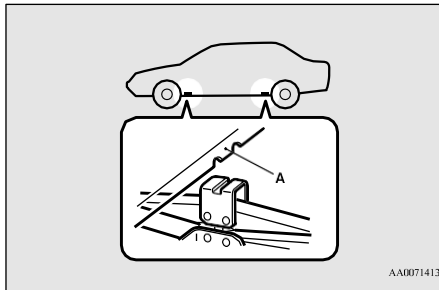

⚠ WARNING

- Set the jack only at the positions shown here. If the jack is set at a wrong position, it could dent your vehicle or the jack might fall over and cause personal injury.
- Do not use the jack on a tilted or soft surface. Otherwise, the jack might slip and cause personal injury. Always use the jack on a flat, hard surface. Before setting the jack, make sure there are no sand or pebbles under the jack base.

NOTE

- If you raise the vehicle with a garage jack, refer to “If your vehicle is raised with a garage jack” on page 10-3.

3. Rotate the jack by hand until the flange portion (B) fits in the groove (C) at the top of the jack.

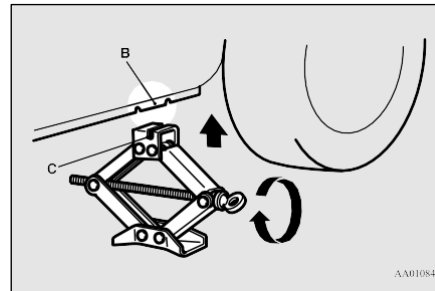

How to change a tyre

4. Insert the bar (D) into the wheel nut wrench (E). Then put the end of the bar into the shaft's jack end, as shown in the illustration.

Slowly rotate the wheel nut wrench until the tyre is raised slightly off the ground surface.

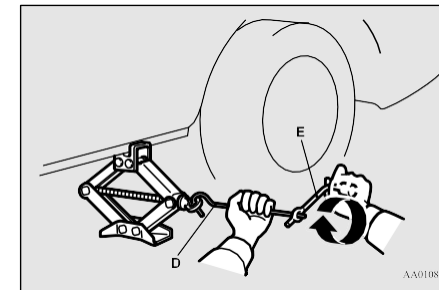

⚠ WARNING

- Stop jacking up the vehicle as soon as the tyre is raised off the ground. It is dangerous to raise the vehicle any higher.
- Do not get under your vehicle while using the jack.
- Do not bump the raised vehicle or leave it sitting on the jack for a long time. Both are very dangerous.
- Do not use a jack except the one that came with your vehicle.
- The jack should not be used for any purpose other than to change a tyre.

How to change a tyre

⚠ WARNING

- No one should be in your vehicle when using the jack.
- Do not start or run the engine while your vehicle is on the jack.
- Do not turn the raised wheel. The tyres still on the ground could turn and make your vehicle fall off the jack.

5. Remove the wheel nuts with the wheel nut wrench, then take the wheel off.

8

⚠ CAUTION

- Handle the wheel carefully when changing the tyre, to avoid scratching the wheel surface.

6. Clean out any mud, etc. on the hub surface (F), hub bolts (G) or in the installation holes (H) in the wheel, and then mount the spare tyre.

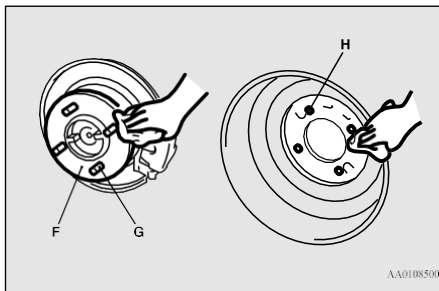

⚠ WARNING

- Mount the spare wheel with the valve stem (I) facing outboard. If you cannot see the valve stem (I), you have installed the wheel backwards. Operating the vehicle with the spare wheel installed backwards can cause vehicle damage and result in an accident.

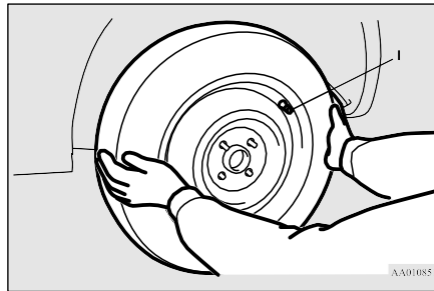

7. Temporarily tighten the wheel nuts by hand until the tapered parts of the wheel nuts make light contact with the seats of the wheel holes and the wheel is not loose.

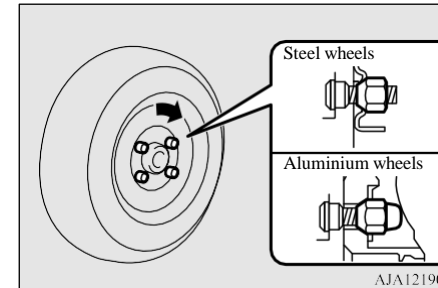

⚠ CAUTION

- Never apply oil to either the wheel bolts or the nuts or they will tighten too much.

8-10 For emergencies

How to change a tyre

8. Lower the vehicle slowly by rotating the wheel nut wrench anticlockwise until the tyre touches the ground.

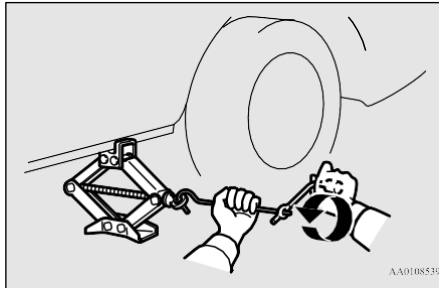

9. Tighten the nuts in the order shown in the illustration until each nut has been tightened to the torque listed here.

Tightening torque
88 to 108 N•m

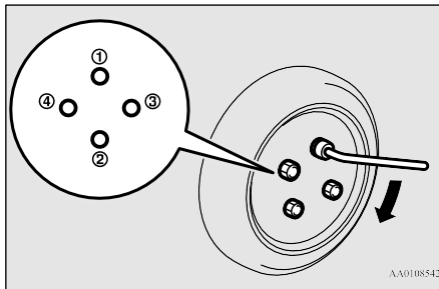

CAUTION

- Never use your foot or a pipe extension for extra force in the wheel nut wrench. If you do so, you will tighten the nut too much.

10. Lower the jack all the way and remove it.
11. Check your tyre inflation pressure at the next gas station. The correct pressures are shown on the driver's door label. See the illustration.

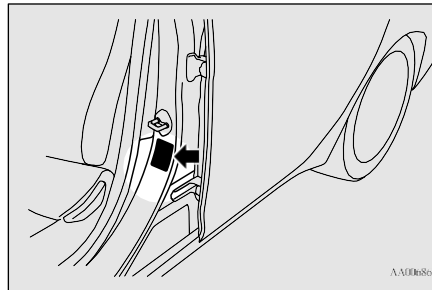

12. On vehicles equipped with tyre pressure monitoring system (TPMS), after filling your tyres to the correct pressure, reset the tyre pressure monitoring system (TPMS). Refer to "Tyre pressure monitoring system (TPMS): Reset of low tyre pressure warning threshold" on page 6-48.

CAUTION

- After changing the tyre and driving the vehicle about 1,000 km, retighten the wheel nuts to make sure that they have not come loose.
- If the steering wheel vibrates when driving after changing the tyre, have the tyre checked for balance at your nearest authorised MITSUBISHI MOTORS dealer.
- Do not mix one type of tyre with another or use a different size from the one listed. This would cause early wear and poor handling.

To store the flat tyre or spare wheel

E00803701466

1. To store the flat tyre or spare wheel, fit the installation clamp (A) by turning it clockwise.

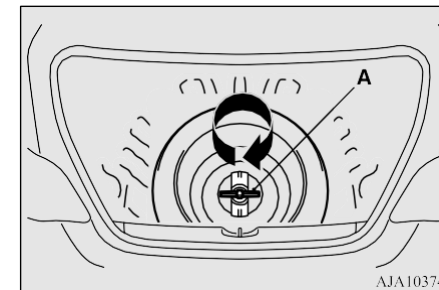

How to change a tyre

NOTE

- On vehicles with compact spare wheel, the clamp cannot be used for the flat tyre with a normal size wheel. Store the flat tyre under the luggage floor board in the luggage compartment.
If the flat tyre is stored on the luggage floor board, the luggage floor board might be damaged.

2. Have your damaged tyre repair as soon as possible.

8

To store the tools and jack

E0080380053

Reverse the removing procedure when storing the jack, bar and wheel nut wrench. Refer to “Tools and jack” on page 8-5.

Wheel covers*

E00801301804

To remove

1. Wrap the tip of the jack bar with a cloth, insert it into the notch provided in the wheel cover, and use it to lever up the cover a little.

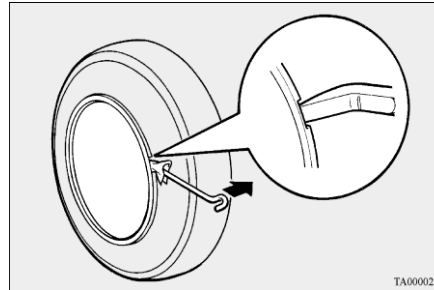

2. With the cover raised a little, pry it off completely using the jack bar. Insert the jack bar under the cover, and move it around the circumference, prying the cover away from the wheel little by little as you move the bar around.

CAUTION

- If you try to use your hands, they may be hurt by the edge of the wheel cover.

NOTE

- The wheel cover is made of plastic; take care when prying it off.

To install

1. Make sure the tabs (A) of the back of the wheel cover are not broken and correctly fitted on the rings (B). If in doubt, do not install the wheel cover and consult your MITSUBISHI MOTORS dealer.

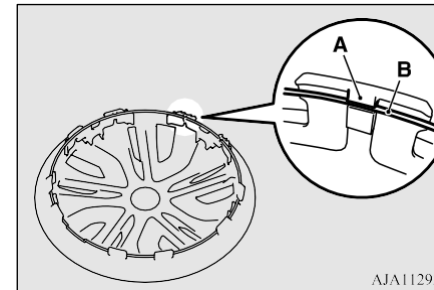

2. Align the air valve (C) of the tyre with the notch (D) in the wheel cover.

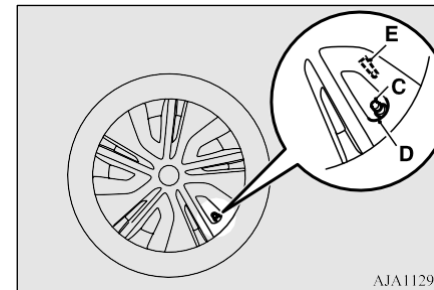

NOTE

- Full wheel covers have a symbol mark (E) provided on the reverse side to show the air valve location.
Before installing the wheel cover to the wheel, make sure that the opening with the symbol mark is correctly aligned with the air valve.

3. Press the bottom part (F) of the wheel cover into the wheel.
4. Gently press both sides (G) of the wheel cover and hold them in place with your knees.
5. Gently tap around the circumference of the wheel cover at the top (H), then press the wheel cover into place.

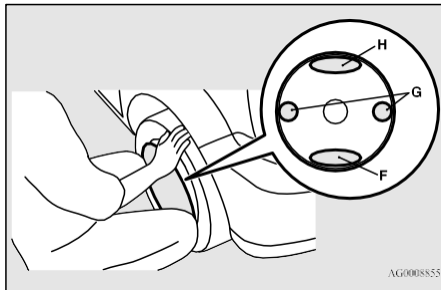

Towing

E00801506595

If your vehicle needs to be towed

If towing is necessary, we recommend you to have it done by your MITSUBISHI MOTORS dealer or a commercial tow truck service.

In the following cases, transport the vehicle using a tow truck.

- The engine runs but the vehicle does not move or abnormal noise is produced.
- Inspection of the vehicle's underside reveals that oil or some other fluid is leaking.

If a wheel gets stuck in a ditch, do not try to tow the vehicle. Please contact your authorised MITSUBISHI MOTORS dealer or a commercial tow truck service for assistance.

Only when you cannot receive a towing service from a MITSUBISHI MOTORS dealer or commercial tow truck service, tow your vehicle carefully in accordance with the instructions given in "Emergency towing" in this part.

Towing

The regulations concerning towing may differ from country to country. It is recommended that you obey the regulations of the area where you are driving your vehicle.

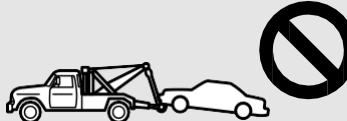
A 

B Towing with rear wheels off the ground. Do not tow CVT vehicles with this style.

C Towing with front wheels off the ground.

D 

E 

AJE100410

Towing

Towing the vehicle by a tow truck

⚠ CAUTION

- This vehicle must not be towed by a tow truck using sling lift type equipment (Type A) as illustrated. Using a sling lift will damage the bumper and front end.
- Do not tow CVT vehicles with the driving wheels on the ground (Type B) as illustrated. If the vehicle is towed like this, the automatic transmission (CVT) fluid may not reach all parts of the transmission, thus damaging it.
If you tow CVT vehicles, use Type C, D or E equipment.
- If the transmission is malfunctioning or damaged, transport the vehicle with the driving wheels on a carriage (Type C, D or E) as illustrated.

8

⚠ CAUTION

- On vehicles with the Active Stability Control (ASC), if the vehicle is towed with the ignition switch in the “ON” position or the operation mode in ON and only the front wheels or only the rear wheels raised off the ground (Type B or C), the Active Stability Control (ASC) may operate, resulting in an accident. When towing the vehicle with the rear wheels raised, turn the ignition switch to the “ACC” position or put the operation mode in ACC. When towing the vehicle with the front wheels raised, keep the ignition switch or the operation mode as follows.
[Except for vehicles equipped with the keyless operation system]
The ignition switch is in “LOCK” or “ACC” position.
[Vehicles equipped with the keyless operation system]
The operation mode is in OFF or ACC.

Towing with rear wheels off the ground (Type B - M/T vehicles only)

Place the gearshift lever in the “Neutral” position.

Turn the ignition switch to the “ACC” position or put the operation mode in ACC and secure the steering wheel in a straight-ahead position with a rope or tie-down strap. Never place the ignition switch in the “LOCK” posi-

tion or put the operation mode in OFF when towing.

Towing with front wheels off the ground (Type C)

Release the parking brake.

Place the gearshift lever in the “Neutral” position (M/T) or the selector lever in the “N” (NEUTRAL) position (CVT).

Emergency towing

If towing service is not available in an emergency, your vehicle may be temporarily towed by a rope secured to the towing hook. In case of your vehicle is to be towed by another vehicle, pay careful attention to the following points.

If your vehicle is to be towed forward by another vehicle

1. Take out the towing hook, wheel nut wrench and jack bar. (Refer to “Tools and jack” on page 8-5.)
2. Cover the tip of the jack bar with a cloth, then use it to remove the cover (A) that is located on the front bumper.

Towing

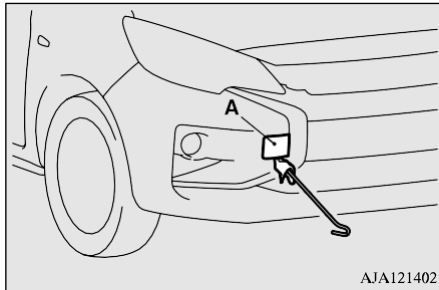

AJA121402

3. Use the wheel nut wrench (B) to securely mount the towing hook (C).

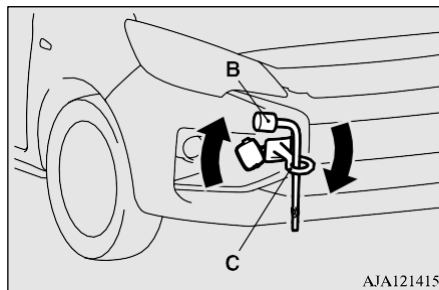

AJA121415

4. Secure the tow rope to the front towing hook.

CAUTION

- Do not tow the vehicle with the rope at an excessive diagonal angle.

NOTE

- To avoid deforming or otherwise damaging the vehicle body when hooking the rope onto the towing hook, observe the following instructions:
 - Mount the towing hook securely.
 - Do not attach the rope to any part of the vehicle other than the towing hook.
 - Ensure that the towing rope is taut when the towing vehicle moves away.

5. Keep the engine running.

If the engine is not running, perform the following operation to unlock the steering wheel.

[Except for vehicles with the keyless operation system]

On vehicles with M/T, turn the ignition key to the “ACC” or “ON” position.

On vehicles with CVT, turn the ignition key to the “ON” position.

[For vehicles with the keyless operation system]

On vehicles with M/T, put the operation mode in ACC or ON.

On vehicles with CVT, put the operation mode in ON.

NOTE

- For vehicles equipped with the Auto Stop & Go (AS&G) system, press the “Auto Stop & Go (AS&G) OFF” switch to deactivate the Auto Stop & Go (AS&G) system before stopping the vehicle. Refer to “To deactivate” on page 6-25.

WARNING

- When the engine is not running, the brake booster and power steering system do not operate. This means higher brake depression force and higher steering effort are required. Therefore, vehicle operation is more difficult than usual.

CAUTION

- Do not leave the key in the “LOCK” position or the operation mode in OFF. The steering wheel will lock, causing loss of control.

6. Place the gearshift lever in the “Neutral” position (M/T) or the selector lever in the “N” (NEUTRAL) position (CVT).

7. Turn on the hazard warning lamps if required by law. (Follow the local driving laws and regulations.)

8. During towing make sure that close contact is maintained between the drivers of both vehicles, and that the vehicles travel at low speed.

For emergencies 8-15

Operation under adverse driving conditions

⚠ WARNING

- **Avoid sudden braking, sudden acceleration and sharp turning; such operation could cause damage to the towing hooks or the tow rope.**
People in the vicinity could be injured as a result.
- **When towing or being towed down a long slope, the brakes may overheat reducing the effectiveness. In this situation, have your vehicle transported by a tow truck.**

8

⚠ CAUTION

- The person in the vehicle being towed must pay attention to the brake lamps of the towing vehicle and make sure the rope never becomes slack.
- When the vehicle with CVT is to be towed by another vehicle with the all wheels on the ground, make sure that the towing speed and distance given below are never exceeded, causing damage to the transmission.

Towing speed: 40 km/h
Towing distance: 40 km

For the towing speed and the towing distance, follow the local driving laws and regulations.

9. When finished towing, remove the towing hook, and stow it in the specified location. Refer to “Tools and jack” on page 8-5.

8-16 For emergencies

When installing the cover, align the hook with the cut out area on the vehicle, and firmly insert.

If your vehicle is to be towed rearward by another vehicle

If your vehicle is stuck in sand, mud, snow, etc., use the rear towing hook (A) as shown in the illustration.

Secure the tow rope to the rear towing hook.

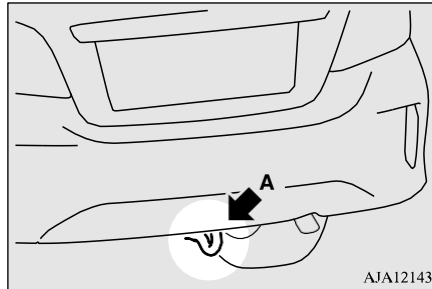

⚠ WARNING

- **When towing your vehicle out of a stuck position, be sure that the area around the vehicle is clear of people and physical objects.**

NOTE

- Using any part other than the designated towing hooks (A) could result in damage to the vehicle body.

Towing another vehicle

Your vehicle cannot be used to tow another vehicle.

Operation under adverse driving conditions

E00801702733

On a flooded road

- Avoid flooded roads. Water could enter the brake discs, resulting in temporarily ineffective brakes. In such cases, lightly depress the brake pedal to see if the brakes operate properly. If they do not, lightly depress the pedal several times while driving in order to dry the brake pads.
- When driving in rain or on a road with many puddles a layer of water may form between the tyres and the road surface. This reduces a tyre's frictional resistance on the road, resulting in loss of steering stability and braking capability.

To cope with this, observe the following items:

- (a) Drive your vehicle at a slow speed.
- (b) Do not drive on worn tyres.
- (c) Always maintain the specified tyre inflation pressures.

On a snow-covered or frozen road

- When driving on a snow-covered or frozen road, it is recommended that you use snow tyres or tyre chains.
Refer to the “Snow tyres” and “Tyre chains” sections.
- Avoid high-speed operation, sudden acceleration, abrupt brake application and sharp cornering.

- Depressing the brake pedal during travel on snowy or icy roads may cause tyre slippage and skidding. When traction between the tyres and the road is reduced the wheels may skid and the vehicle cannot readily be brought to a stop by conventional braking techniques. Braking will differ, depending upon whether you have anti-lock brake system (ABS). If you do have ABS, brake by pressing the brake pedal hard, and keeping it pressed. If you do not have ABS, pump the brake pedal with short rapid jabs, each time fully applying and fully releasing for greatest effect.
- Allow extra distance between your vehicle and the vehicle in front of you, and avoid sudden braking.
- Accumulation of ice on the braking system can cause the wheels to lock. Pull away from a standstill slowly after confirming safety around the vehicle.

CAUTION

- Do not press the accelerator pedal rapidly. If the wheels break free of the ice, the vehicle could suddenly start moving and possibly cause an accident.

Operation under adverse driving conditions

On a bumpy or rutted road

- Drive as slow as possible when driving on bumpy or rutted roads.

CAUTION

- The impact on tyres and/or wheels when driving on a bumpy or rutted road can damage the tyre and/or wheel.
- The vehicle's body, bumper, muffler and other parts may be damaged if the vehicle is:
 - driven over a step (for example, at the entrance or exit of a parking lot);
 - parked too closely against a kerb or parking block, or by the side of a road with kerbstones;
 - driven on a steep slope.

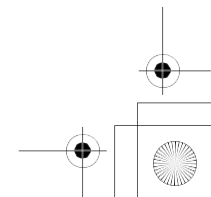
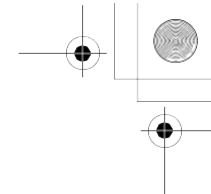
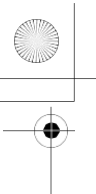

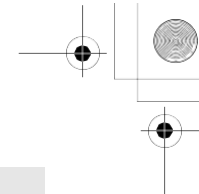
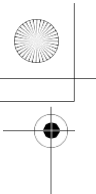

Vehicle care

Vehicle care precautions.....	9-2
Cleaning the interior of your vehicle.....	9-2
Cleaning the exterior of your vehicle.....	9-3

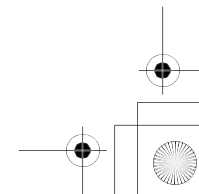
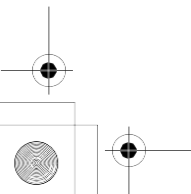
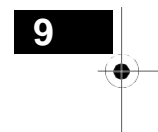

Vehicle care precautions

Vehicle care precautions

E00900100971

In order to maintain the value of your vehicle, it is necessary to perform regular maintenance using the proper procedures. Always maintain your vehicle in compliance with any environmental pollution control regulations. Carefully select the materials used for washing, etc., to be sure that they do not contain corrosives; if in doubt, contact your authorised MITSUBISHI MOTORS dealer for assistance in the selection of these materials.

9

CAUTION

- Cleaning products can be dangerous. Always follow the instructions of the cleaning product supplier.
- To avoid damage, never use the following to clean your vehicle.
 - Petrol
 - Paint Thinner
 - Benzine
 - Kerosene
 - Turpentine
 - Naphtha
 - Lacquer Thinner
 - Carbon Tetrachloride
 - Nail Polish Remover
 - Acetone

Cleaning the interior of your vehicle

E00900201634

After cleaning the interior of your vehicle with water, cleaner or similar, wipe and dry in a shady, well-ventilated area.

NOTE

- To clean the inside of the rear window, always use a soft cloth and wipe the window glass along the demister heater element so as not to cause damage.

CAUTION

- Do not use organic substances (solvents, benzine, kerosene, alcohol, petrol, etc.) or alkaline or acidic solutions. These chemicals can cause discolouring, staining or cracking of the surface. If you use cleaners or polishing agents, make sure their ingredients do not include the substances mentioned above.

Plastic, vinyl leather, fabric and flocked parts

E00900301475

1. Lightly wipe these off with a soft cloth soaked in a mild soap and water solution.

2. Dip cloth in fresh water and wring out well. Using this cloth, wipe off the detergent thoroughly.

NOTE

- Do not use cleaners, conditioners, and protectants containing silicones or wax. Such products can cause discolouring and, when applied to the instrument panels or other parts, may cause reflections on the windscreen and obscure vision. Also, if such products get on the switches of the electrical accessories, it may lead to failure of these accessories.
- The surface of gloss center panel may be scratched if it is rubbed hard by a brush, synthetic fiber or hard cloth.
- Do not use synthetic fiber or dry cloth. They can cause discolouring or damaging the surface.
- Do not place a deodorizer on the instrument panel or near lamps and instruments. The ingredients for deodorizer can cause discolouring or cracking.

Upholstery

E00900500193

1. To maintain the value of your new vehicle, handle the upholstery carefully and keep the interior clean.

- Use a vacuum cleaner and brush to clean the seats. If stained, vinyl and synthetic leather should be cleaned with an appropriate cleaner, Cloth fabrics can be cleaned with either upholstery cleaner or a mild soap and water solution.
2. Clean the carpeting with a vacuum cleaner and remove any stains with carpet cleaner. Oil and grease can be removed by lightly dabbing with a clean colourfast cloth and stain remover.

Genuine leather*

E00900600947

1. To clean, lightly wipe the leather with a soft cloth soaked in a mild soap and water solution.
2. Dip cloth in fresh water and wring it out well. Using this cloth, wipe off the detergent thoroughly.
3. Apply leather protecting agent to the genuine leather surface.

NOTE

- If genuine leather is wet with water or is washed in water, wipe off water as quickly as possible with a dry, soft cloth. If left damp, mildew may grow.
- Organic solvents such as benzine, kerosene, alcohol and petrol, acid or alkaline solvents may discolour the genuine leather surface. Be sure to use neutral detergents.

NOTE

- Remove dirty patches or oil substances quickly as they can stain genuine leather.
- The genuine leather surface may harden and shrink if it is exposed to direct rays of the sun for long hours. When your vehicle is parked, place it in the shade as much as possible.
- When the temperature of the vehicle interior rises in summer, vinyl products left on the genuine leather seat may deteriorate and stick to the seat.

Cleaning the exterior of your vehicle

E00900700137

If the following is left on your vehicle, it may cause corrosion, discolouration and stains, wash the vehicle as soon as possible.

- Seawater, road deicing products.
- Soot and dust, iron powder from factories, chemical substance (acids, alkalis, coal-tar, etc.).
- Droppings from birds, carcasses of insects, tree sap, etc.

Washing

E00900904515

Chemicals contained in the dirt and dust picked up from the road surface can damage

Cleaning the exterior of your vehicle

the paint coat and body of your vehicle if left in prolonged contact.

Frequent washing and waxing is the best way to protect your vehicle from this damage. This will also be effective in protecting it from environmental elements such as rain, snow, salt air, etc.

Do not wash the vehicle in direct sunlight. Park the vehicle in the shade and spray it with water to remove dust. Next, using an ample amount of clean water and a car washing brush or sponge, wash the vehicle from top to bottom.

Use a mild car washing soap if necessary. Rinse thoroughly and wipe dry with a soft cloth. After washing the vehicle, carefully clean the joints and flanges of the doors, bonnet, etc., where dirt is likely to remain.

9

CAUTION

- When washing the under side of your vehicle or wheel, be careful not to injure your hands.
- If your vehicle has rain sensor, place the wiper switch lever in the "OFF" position to deactivate the rain sensor before washing the vehicle. Otherwise, the wipers will operate in the presence of water spray on the wind-screen and may get damaged as a result.
- Refrain from excessively using a car wash as its brushes may scratch the paint surface, causing it to lose its gloss. Scratches will be especially visible on darker coloured vehicles.

Cleaning the exterior of your vehicle

CAUTION

- Never spray or splash water on the electrical components in the engine compartment, as this may adversely affect engine starting. Exercise caution also when washing the underbody; be careful not to spray water into the engine compartment.
- Some types of hot water washing equipment apply high pressure and heat to the vehicle. They may cause heat distortion and damage to the vehicle resin parts and may result in flooding of the vehicle interior. Therefore;
 - Maintain a distance of approx. 70 cm or more between the vehicle body and the washing nozzle.
 - When washing around the door glass, hold the nozzle at a distance of more than 70 cm and at right angles to the glass surface.
- After washing the vehicle, drive the vehicle slowly while lightly depressing the brake pedal several times in order to dry out the brakes.

Leaving the brakes wet could result in reduced braking performance. Also, there is a possibility that they could freeze up or become inoperative due to rust, rendering the vehicle unable to move.
- Using an automatic car wash, pay attention to the following items, referring to the operation manual or consulting a car wash operator. If the following procedure is not followed, it could result in damage to your vehicle.
 - The outside rear-view mirrors are retracted.

9

CAUTION

- The antenna is removed.
- The wiper arm assembly is taped.
- If your vehicle is equipped with a rear spoiler, consult a car wash operator before using the car wash.
- If your vehicle has rain sensor, place the wiper switch lever in the “OFF” position to deactivate the rain sensor.

During cold weather

The salt and other chemicals spread on the roads in some areas in winter can have a harmful effect on the vehicle body. You should therefore wash the vehicle as often as possible in accordance with our care-instructions. It is recommended to have a preservative applied and the underfloor protection checked at an authorised MITSUBISHI MOTORS dealer before and after the cold weather season.

After washing your vehicle, wipe off all waterdrops from the rubber parts around the doors to prevent the doors from freezing.

NOTE

- To prevent freezing of the weatherstripping on the doors, bonnet, etc., they should be treated with silicone spray.

Waxing

E00901000906

Waxing the vehicle will help prevent the adherence of dust and road chemicals to the paintwork. Apply a wax solution after washing the vehicle, or at least once every three months to assist displacing of water.

Do not wax your vehicle in direct sunlight. You should wax after the surfaces have cooled.

For information on how to use wax refer to the instruction manual of the wax.

CAUTION

- Waxes containing high abrasive compounds should not be used.

Polishing

E00901100082

The vehicle should only be polished if the paintwork has become stained or lost its lustre. Matt-finish parts and plastic bumpers must not be polished, polishing these parts will stain them or damage their finish.

Cleaning plastic parts

E00901302062

Use a sponge or chamois leather.

If a car wax adheres on a grey or black rough surface of the bumper, moulding or lamps, the surface becomes white. In such a case, wipe it off using lukewarm water and soft cloth or chamois leather.

CAUTION

- Do not use a scrubbing brush or other hard tools as they may damage the plastic part surface.
- Do not bring the plastic parts into contact with petrol, light oil, brake fluids, engine oils, greases, paint thinners, and sulphuric acid (battery electrolyte) which may stain, crack or discolour the plastic parts. Also, be sure to avoid even brief contact with chemicals such as coating materials, because they cause cracks that allow water to enter the lamps.

If they touch the plastic parts wipe them off with soft cloth, chamois or the like and an aqueous solution of neutral detergent then immediately rinse the affected parts with water.

Chrome parts

E00901400128

In order to prevent spots and corrosion of chrome parts, wash with water, dry thoroughly, and apply a special protective coat-

ing. This should be done more frequently in winter.

Aluminium wheels*

E00901501751

1. Remove dirt using a sponge while sprinkling water on the wheels.
2. Use neutral detergent on any dirt that cannot be removed easily with water. Rinse off the neutral detergent after washing the wheels.
3. Dry the wheels thoroughly using a chamois leather or a soft cloth.

CAUTION

- Do not use a brush or other hard implement on the wheels. Doing so could scratch the wheels.
- Do not use any cleaner that contains an abrasive substance or is acidic or alkaline. Doing so could cause the coating on the wheels to peel or become discoloured or stained.
- Do not directly apply hot water using a steam cleaner or by any other means.
- Contact with seawater and road deicer can cause corrosion. Rinse off such substances as soon as possible.

Cleaning the exterior of your vehicle

Window glass

E00901601260

The window glass can normally be cleaned using only a sponge and water. Glass cleaner can be used to remove oil, grease, dead insects, etc. After washing the glass, wipe dry with a clean, dry, soft cloth. Never use the same cloth to wipe the window glass as would be used to wipe the paintwork; wax from the painted surfaces could adhere to the glass and reduce its transparency and visibility.

NOTE

- To clean the inside of the rear window, always use a soft cloth and wipe the window glass along the demister heater element so as not to cause damage.

9

Wiper blades

E00901700088

Use a soft cloth and glass cleaner to remove grease, dead insects, etc., from the wiper blades. Replace the wiper blades when they no longer wipe properly. (Refer to page 10-14.)



Cleaning the exterior of your vehicle

Engine compartment

E00902101578

Clean the engine compartment at the beginning and end of winter. Pay particular attention to flanges, crevices and peripheral parts where dust containing road chemicals and other corrosive materials might collect.

If salt and other chemicals are used on the roads in your area, clean the engine compartment at least every 3 months.

Never spray or splash water on the electrical components in the engine compartment, as this may cause damage.

9

Do not bring the nearby parts, the plastic parts and so on into contact with sulphuric acid (battery electrolyte) which may crack, stain or discolour them.

If they are in contact, wipe off with soft cloth, chamois or the like and an aqueous solution of neutral detergent then immediately rinse the affected parts with plenty of water.

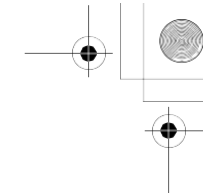

9-6 Vehicle care

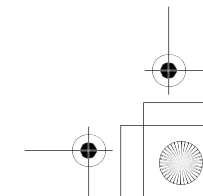
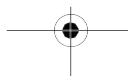

Maintenance

Service precautions	10-2
Catalytic converter	10-3
Bonnet	10-3
Engine oil.....	10-4
Engine coolant	10-6
Washer fluid.....	10-7
Brake fluid.....	10-8
Battery	10-8
Tyres.....	10-10
Wiper blade rubber replacement.....	10-14
General maintenance.....	10-15
For cold and snowy weather	10-16
Fusible links.....	10-16
Fuses.....	10-16
Replacement of lamp bulbs.....	10-20
Masking the headlamps.....	10-27

Service precautions

Service precautions

E01000102524

Adequate care of your vehicle at regular intervals serves to preserve the value and appearance as long as possible.

Some maintenance items can be carried out by the owner (do it yourself), while others should be carried out by an authorised MITSUBISHI MOTORS dealer (periodic inspection and maintenance). In the event a malfunction or a problem is discovered, have it corrected by an authorised MITSUBISHI MOTORS dealer. This section contains information on inspection maintenance procedures that you can do yourself. Follow the instructions and cautions for each of the various procedures.

10

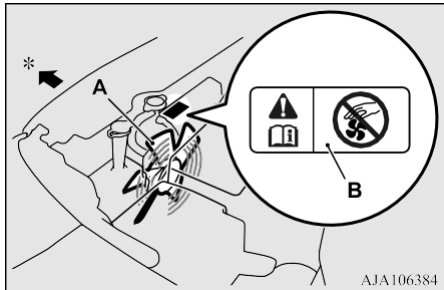

- A- Cooling fan
- B- Caution label
- *: Front of the vehicle

WARNING

- When checking or servicing the inside of the engine compartment, make sure the engine is switched off and has had a chance to cool down.
- If it is necessary to do work in the engine compartment with the engine running, be especially careful that your clothing, hair, etc., does not become caught by the cooling fan, drive belts, or other moving parts.
- After performing the maintenance work, make sure that no tools or cloths are left behind in the engine compartment. If they are left behind, a fire or damage to the vehicle may occur.
- The cooling fan can turn on automatically even if the engine is not running. Turn the ignition switch to the "LOCK" position or put the operation mode in OFF to be safe while you work in the engine compartment.
- Do not smoke, cause sparks or allow open flames around fuel or battery. The fumes are flammable.
- Be extremely cautious when working around the battery. It contains poisonous and corrosive sulphuric acid.
- Do not get under your vehicle with just the body jack supporting it. Always use automotive jack stands.

WARNING

- Improper handling of components and materials used in the vehicle can endanger your personal safety. Consult an authorised MITSUBISHI MOTORS dealer for necessary information.

Check items of engine compartment are located as shown in the figure below.

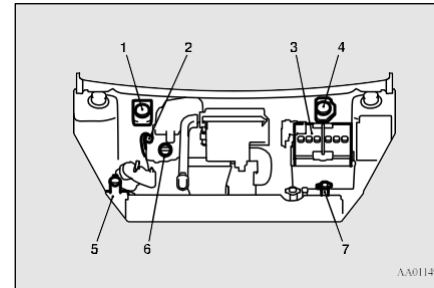

1. Brake fluid reservoir (RHD)
2. Engine oil level dipstick
3. Battery
4. Brake fluid reservoir (LHD)
5. Washer fluid reservoir
6. Engine oil cap
7. Engine coolant reservoir

10-2 Maintenance

If your vehicle is raised with a garage jack

E01011501130

Only use the appointed position as shown in the illustration.

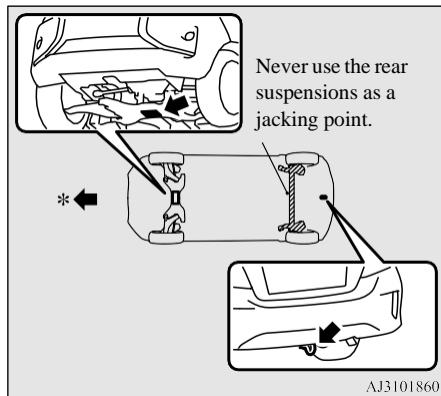

*- Front of the vehicle

! WARNING

- Set the jack only at the positions shown here. If the jack is set at a wrong position, it could damage your vehicle or the jack might fall over and cause personal injury.

! WARNING

- Do not use the jack on a tilted or soft surface. Otherwise, the jack might slip and cause personal injury. Always use the jack on a flat, hard surface. Before setting the jack, make sure there are no sand or pebbles under the jack base.

Catalytic converter

E01000202440

The exhaust gas scavenging devices used with catalytic converter are extremely efficient for the reduction of noxious gases. The catalytic converter is installed in the exhaust system.

It is important to keep the engine properly tuned to ensure proper catalyst operation and prevent possible catalyst damage.

! WARNING

- As with any vehicle, do not park or operate this vehicle in areas where combustible materials such as dry grass or leaves can come in contact with a hot exhaust since a fire could occur.
- Paint should not be applied to the catalytic converter.

Catalytic converter

NOTE

- Use fuel of the type recommended in "Fuel selection" on page 2-2.

Bonnet

E01000304823

To open

1. Pull the release lever toward you to unlock the bonnet.

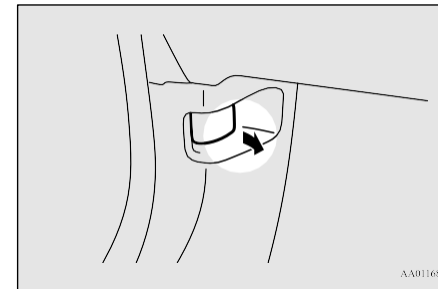

Engine oil

2. Raise the bonnet while pressing the safety lock.

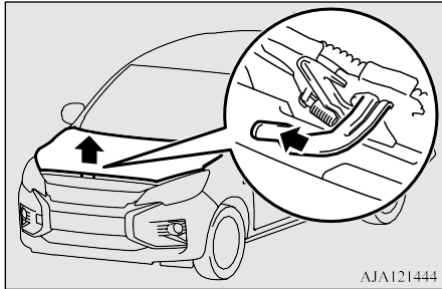

NOTE

- Only open the bonnet when the wipers are in the original position. Failure to do so may cause damage to the bonnet, wiper arms or windscreen.

10

3. Support the bonnet by inserting the support bar in its slot.

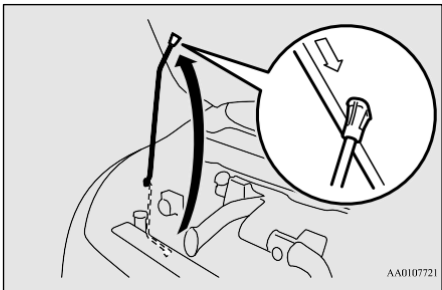

CAUTION

- Note that the support bar may disengage the bonnet if the open bonnet is lifted by a strong wind.
- After inserting the support bar into the slot, make sure the bar supports the bonnet securely from falling down on to your head or body.

To close

1. Unlatch the support bar and clip it in its holder.
2. Slowly lower the bonnet to a position approximately 20 cm above the closed position, then let it drop.
3. Make sure the bonnet is securely locked by softly lifting the centre of the bonnet.

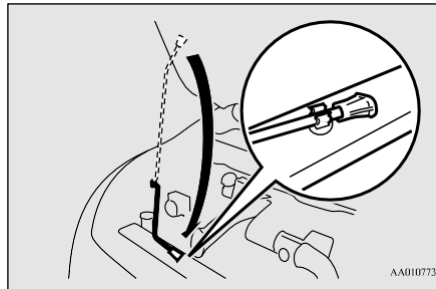

CAUTION

- Be careful that hands or fingers are not trapped when closing the bonnet.
- Before driving, make sure that the bonnet is securely locked. An incompletely locked bonnet can suddenly open while driving. This can be extremely dangerous.

NOTE

- If this does not close the bonnet, release it from a slightly higher position.
- Do not press down the bonnet hard with a hand as it may damage the bonnet.

Engine oil

E01000405195

To check and refill engine oil

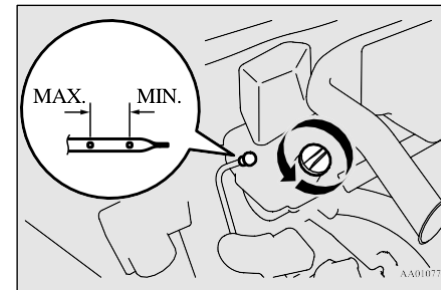

Engine oil

The engine oil used has a significant effect on the engine's performance, service life and startability. Be sure to use oil of the recommended quality and appropriate viscosity. All engines consume a certain amount of oil during normal operation. Therefore, it is important to check the oil level at regular intervals or before starting a long trip.

1. Park the vehicle on a horizontal surface.
2. Switch off the engine.
3. Wait a few minutes.
4. Remove the dipstick and wipe it with a clean cloth.
5. Reinsert the dipstick as far as it goes.
6. Remove the dipstick and read the oil level, which should always be within the range indicated.
7. If the oil level is below the specified limit, remove the cap located on the cylinder head cover and add enough oil to raise the level to within the specified range. Do not overfill to avoid engine damage. Be sure to use the specified engine oil and do not mix various types of oil.
8. After adding oil, close the cap securely.
9. Confirm the oil level by repeating step 4 to 6.

NOTE

- The engine oil will deteriorate rapidly if the vehicle is subjected to severe conditions, requiring earlier oil replacement. Please refer to the maintenance schedule.
- For handling of used engine oils, refer to page 2-5.

Selection of engine oil

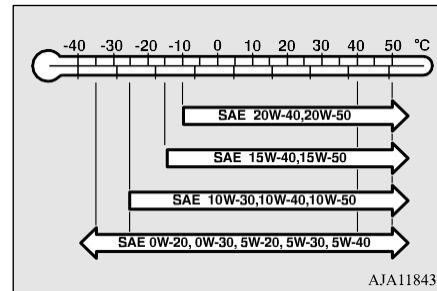

- Select engine oil of the proper SAE viscosity number according to the atmospheric temperature. SAE 0W-20, 0W-30, 5W-20, 5W-30, and 5W-40 engine oils can only be used if they meet ACEA A3/B3, A3/B4 or A5/B5 and API SG (or higher) specifications.
- Use engine oil conforming to the following classification:

- API classification: “For service SG” or higher
- ILSAC certificated oil
- ACEA classification: “For service A1/B1, A3/B3, A3/B4, or A5/B5”

NOTE

- Use of additives is not recommended since they may reduce the effectiveness of additives already included in the engine oil. It may result in failure of the mechanical assembly.

Engine coolant

Engine coolant

E01000503349

To check the coolant level

A translucent coolant reservoir (A) is located in the engine compartment.

The coolant level in this tank should be kept between the “L” (LOW) and “F” (FULL) marks when measured while the engine is cold.

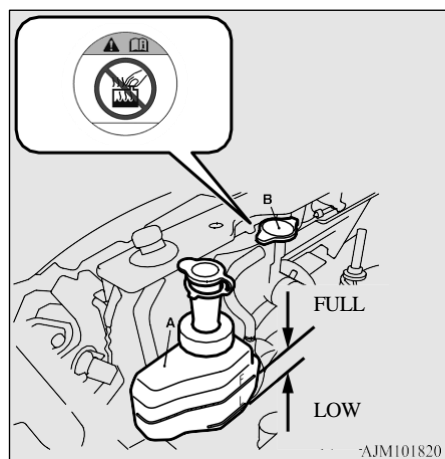

To add coolant

The cooling system is a closed system and normally the loss of coolant should be very slight. A noticeable drop in the coolant level could indicate leakage. If this occurs, have the system checked at an authorised MITSUBISHI MOTORS dealer as soon as possible.

If the level should drop below the “L” (LOW) level on the reservoir, open the lid and add coolant.

Also, if the reservoir is completely empty, remove the radiator cap (B) and add coolant until the level reaches the filler neck.

WARNING

- Do not open the radiator cap while the engine is hot. The coolant system is under pressure and any hot coolant escaping could cause severe burns.

Anti-freeze

The engine coolant contains an ethylene glycol anti-corrosion agent. Some parts of the engine are cast aluminium alloy, and periodic changing of the engine coolant is necessary to prevent corrosion of these parts.

Use “MITSUBISHI MOTORS GENUINE SUPER LONG LIFE COOLANT PREMIUM” or equivalent*.

*: similar high quality ethylene glycol based non-silicate, non-amine, non-nitrate and non-borate coolant with long life hybrid organic acid technology

MITSUBISHI MOTORS GENUINE Coolant has excellent protection against corrosion and rust formation of all metals including aluminium and can avoid blockages in the radiator, heater, cylinder head, engine block, etc.

Because of the necessity of this anti-corrosion agent, the coolant must not be replaced with plain water even in summer. The required concentration of anti-freeze differs depending on the expected ambient temperature.

Above -35 °C: 50 % concentration of anti-freeze

Below -35 °C: 60 % concentration of anti-freeze

CAUTION

- Do not use alcohol or methanol anti-freeze or any engine coolants mixed with alcohol or methanol anti-freeze. The use of an improper anti-freeze can cause corrosion of the aluminium components.
- Do not use water to adjust the concentration of coolant.

Washer fluid

⚠ CAUTION

- Concentrations exceeding 60 % will result in a reduction of both the anti-freeze and cooling performance thus adversely affecting the engine.
- Do not top up with water only.

During cold weather

The concentration should be checked before the start of cold weather and anti-freeze added to the system if necessary to prevent damage to engine and radiator due to freezing.

Washer fluid

E01000702908

Open the washer fluid reservoir cap and check the level of washer fluid. If the level is low, replenish the container with washer fluid. Full level is approximately 5 cm below from the upper surface of the reservoir.

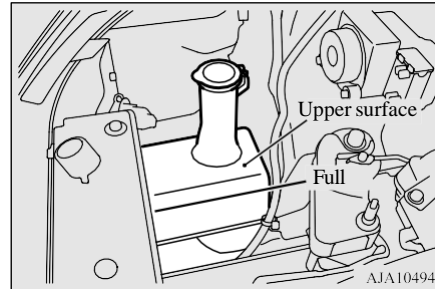

AJA104944

⚠ CAUTION

- If dirt adheres to the inside of the washer nozzle, washer fluid may not spray on the windscreen correctly. The nozzle may be damaged if you attempt to clean out the dirt with a pin or other object. Please contact an authorised MITSUBISHI MOTORS dealer.
- Over-diluting the washer fluid in winter may cause it to freeze onto the windscreen.

During cold weather

To ensure proper operation of the washers at low temperatures, use a fluid containing an anti-freezing agent.

⚠ CAUTION

- Do not use any fluid other than washer fluid. Also, do not use soapy water, glass cleaner, and engine coolant. Other liquids could cause streaking on the vehicle's painted surfaces, damage the washer pump, or clog the nozzle, leading to the washer fluid not spraying.

Brake fluid

Brake fluid

E01000902056

To check the fluid level

The fluid level must be between the “MAX” and “MIN” marks on the reservoir.

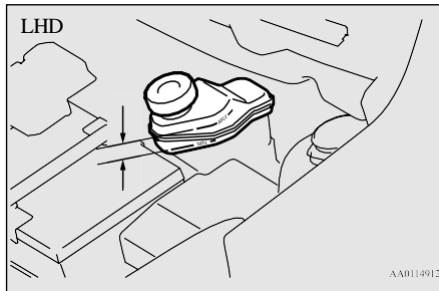

10

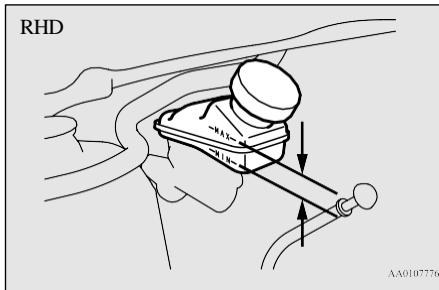

The fluid level is monitored by a float. When the fluid level falls below the “MIN” mark, the brake fluid warning lamp lights up.

The fluid level falls slightly with wear of the brake pads, but this does not indicate any abnormality.

If the fluid level falls markedly in a short length of time, it indicates leaks from the brake system.

If this occurs, have the vehicle checked by an authorised MITSUBISHI MOTORS dealer.

Fluid type

Use brake fluid conforming to DOT3 or DOT4 from a sealed container. The brake fluid is hygroscopic. Too much moisture in the brake fluid will adversely affect the brake system, reducing the performance.

WARNING

- Take care in handling brake fluid as it is harmful to the eyes, may irritate your skin and will damage painted surfaces. Wipe up spills immediately.

If brake fluid gets on your hands or in your eyes, flush immediately with clean water. Follow up with a doctor as necessary.

CAUTION

- Use only the specified brake fluid. Do not mix or add different brand of brake fluid to prevent chemical reaction. Do not let any petroleum-based fluid touch, mix with, or get into the brake fluid. This will damage the seals.
- Keep the reservoir cap closed to prevent the brake fluid from deteriorating except maintenance.
- Clean the filler cap before removing and close the cap securely after maintenance.

Battery

E01001204089

The condition of the battery is very important for quick starting of the engine and proper functioning of the vehicle’s electrical system. Regular inspection and care are especially important in cold weather.

Be sure to have an authorised MITSUBISHI MOTORS dealer check the battery.

Battery precautions

WARNING

- Note operating instructions



When you handle the battery, carefully observe the following cautions for safety.

- No smoking, no naked flames, no sparks



Keep sparks, cigarettes, and flames away from the battery because the battery could explode. Also, do not short-circuit the battery terminals. Doing so could create sparks.

- Shield eyes



Always wear protective eye goggles when working near the battery. Battery electrolyte contains sulphuric acid, so getting it in your eyes is dangerous.

WARNING

- Battery acid



Battery electrolyte contains sulphuric acid, so you must wear gloves and eye protection when handling the battery.

If battery electrolyte gets in your eyes or on your skin, rinse it away with clean water and immediately see a doctor.

If you accidentally swallow battery electrolyte, immediately see a doctor.

If battery electrolyte splashes on your clothing or on the vehicle, rinse it off with lots of water.

- Explosive gas



The battery emits highly explosive hydrogen gas. Ventilate when charging the battery in an enclosed space.

- Keep away from children



Keep it out of reach of children.

- Never remove the battery label or upper cover. Flammable gases may leak and explode.

During cold weather

E0101090071

The capacity of the battery is reduced at low temperatures. This is an inevitable result of its chemical and physical properties. This is why a very cold battery, particularly one that is not fully charged, will only deliver a fraction of the starter current which is normally available.

It is recommended that you have the battery checked by an authorised MITSUBISHI MOTORS dealer before the start of cold weather and, if necessary, have it charged.

This does not only ensure reliable starting, but a battery which is kept fully charged also has a longer life.

Disconnection and connection

E01011001441

To disconnect the battery cable, stop the engine, first disconnect the negative (-) terminal and then the positive (+) terminal. When connecting the battery, first connect the positive (+) terminal and then the negative (-) terminal.

NOTE

- Open the terminal cover (A) before disconnecting or connecting the positive (+) terminal of the battery.

Tyres

NOTE

- Loosen the nut (B), and then disconnect the battery cable from the positive (+) terminal.

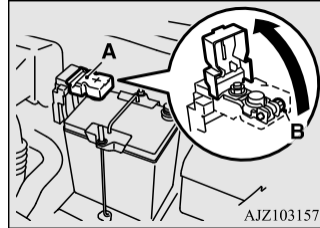

NOTE

- Keep the terminals clean. After the battery is connected, apply terminal protection grease. To clean the terminals, use lukewarm water.
- Check to see if the battery is securely installed and cannot be moved during travel. Also check each terminal for tightness.
- When the vehicle is to be left unused for a long period of time, remove the battery and store it in a place where the battery fluid will not freeze. The battery should be stored only in a fully charged condition.

Tyre inflation pressures

E01001404980

Item	Tyre size	Cargo/ No cargo
Normal tyre	185/55R15 82V	2.2 bar (32 psi) [220 kPa]
Compact spare tyre	T115/70D14 88M	4.2 bar (60 psi) [420 kPa]

Check the tyre inflation pressure of all the tyres while they are cold: if insufficient or excessive, adjust to the specified value.

After the tyre inflation pressure has been adjusted, check the tyres for damage and air leaks. Be sure to put caps on the valves.

CAUTION

- Never disconnect the battery with the ignition switch or the operation mode in ON; doing so could damage the vehicle's electrical components.
 - Never short-circuit the battery; doing so could cause it to overheat and be damaged.
 - If the battery is to be quick-charged, first disconnect the battery cables.
 - In order to prevent a short circuit, be sure to disconnect the negative (-) terminal first.
 - Do not bring the nearby parts, the plastic parts and so on into contact with sulphuric acid (battery electrolyte) which may crack, stain or discolour them.
- If they are in contact, wipe off with soft cloth, chamois or the like and an aqueous solution of neutral detergent then immediately rinse the affected parts with plenty of water.

10

Tyres

E01001300301

WARNING

- **Driving with tyres that are worn, damaged or improperly inflated can lead to a loss of control or blow out of the tyres which can result in a collision with serious or fatal injury.**

Tyre inflation pressure gauge*

E01001501384

1. Take out the tyre inflation pressure gauge.
Refer to “Tools and jack” on page 8-5.
2. Remove the valve cap (A).

NOTE

- Be careful not to lose the valve cap.

3. Clean the area around the tyre valve (B).

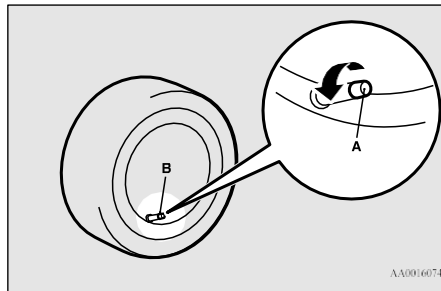

4. Press the tyre inflation pressure gauge (C) straight onto the tyre valve.

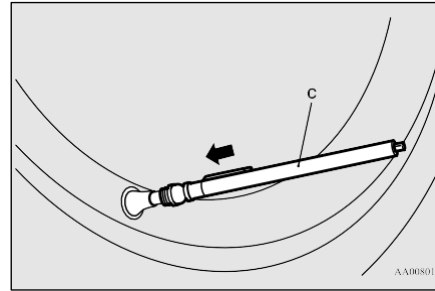

NOTE

- If the tyre inflation pressure gauge is angled (not straight) relative to the tyre valve, air will leak and accurate measurement will not be possible.

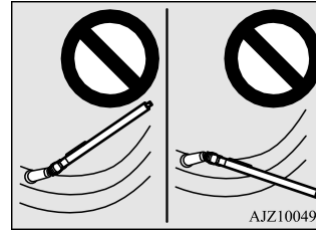

5. Read the tyre inflation pressure from the scale on part D of the tyre inflation pressure gauge.

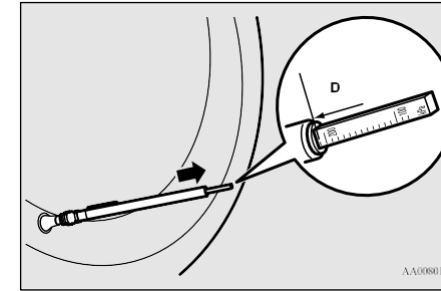

Example: tyre inflation pressure of 210 kPa

NOTE

- One side of the scale shows the pressure in kPa. The other side shows the pressure in kgf/cm².

6. Repeat the measurement a few times to obtain an accurate pressure indication.
7. After taking the measurement, securely fit the valve cap.

Tyres

Wheel condition

E01001800957

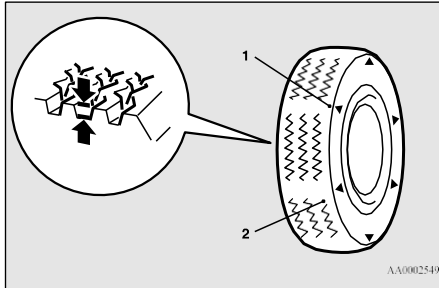

- 1- Location of the tread wear indicator
- 2- Tread wear indicator

10

Check the tyres for cuts, cracks and other damage. Replace the tyres if there are deep cuts or cracks. Also check each tyre for pieces of metal or pebbles.

The use of worn tyres can be very dangerous because of the greater chance of skidding or hydroplaning. The tread depth of the tyres must exceed 1.6 mm in order for the tyres to meet the minimum requirement for use.

Tread wear indicators will appear on the surface of the tyre as the tyre wears, thereby indicating that the tyre no longer meets the minimum requirement for use. When these wear indicators appear, the tyres must be replaced with new ones.

10-12 Maintenance

Replacing tyres and wheels

E01007201660

CAUTION

- Avoid using different size tyres from the one listed and the combined use of different types of tyres, as this can affect driving safety.
Refer to “Tyres and wheels” on page 11-6.
- Even if a wheel has the same rim size and offset as the specified type of wheel, its shape may prevent it from being fitted correctly. Consult an authorised MITSUBISHI MOTORS dealer before using wheels that you have.
- If your vehicle is equipped with a tyre pressure monitoring system, only MITSUBISHI MOTORS genuine wheels should be used. Use of another type of wheel risks air leaks and sensor damage, as it will not be possible to install the tyre pressure sensor properly.
Refer to “Tyre pressure monitoring system (TPMS)” on page 6-45.

Tyre rotation

E01001901421

Tyre wear varies with vehicle conditions, road surface conditions and individual driver’s driving habits. To equalize the wear and help extend tyre life, it is recommended to rotate the tyres immediately after discovery of abnormal wear, or whenever the wear dif-

ference between the front and rear tyres is recognizable.

When rotating tyres, check for uneven wear and damage. Abnormal wear is usually caused by incorrect tyre pressure, improper wheel alignment, out of balance wheel, or severe braking. Consult your authorised MITSUBISHI MOTORS dealer to determine the cause of irregular tread wear.

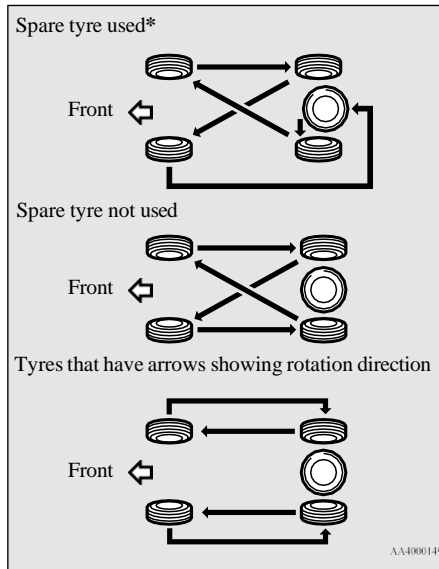

*: If the spare tyre differs from the normal tyre, do not perform tyre rotation using a spare tyre.

CAUTION

- A compact spare tyre can be fitted temporarily in place of a tyre that has been removed during the tyre rotation. However, it must not be included in the regular tyre rotation sequence.

CAUTION

- If the tyres have arrows (A) indicating the correct direction of rotation, swap the front and rear wheels on the left hand side of the vehicle and the front and rear wheels on the right hand side of the vehicle separately. Keep each tyre on its original side of the vehicle. When fitting the tyres, make sure the arrows point in the direction in which the wheels will turn when the vehicle moves forward. Any tyre whose arrow points in the wrong direction will not perform to its full potential.

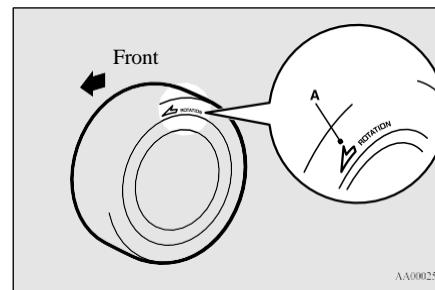

CAUTION

- Avoid the combined use of different types of tyres. Using different types of tyres can affect vehicle performance and safety.

Snow tyres

E01002002181

The use of snow tyres is recommended for driving on snow and ice. To preserve driving stability, mount snow tyres of the same size and tread pattern on all four wheels.

Snow tyres worn more than 50 % are no longer suitable for use as snow tyres.

Snow tyres which do not meet specifications must not be used.

CAUTION

- Observe permissible maximum speed for your snow tyres and the legal speed limit.
- If your vehicle is equipped with a tyre pressure monitoring system, only MITSUBISHI MOTORS genuine wheels should be used. Use of another type of wheel risks air leaks and sensor damage, as it will not be possible to install the tyre pressure sensor properly. Refer to “Tyre pressure monitoring system (TPMS)” on page 6-45.

NOTE

- The laws and regulations concerning snow tyres (driving speed, required use, type, etc.) vary. Find out and follow the laws and regulations in the area you intend to drive.

Wiper blade rubber replacement

Tyre chains

E01002103293

It is recommended that snow chains are carried in snow regions and fitted when required to the front wheels.

The tyres fitted to your vehicle as original equipment allow you to fit tyre chains if they are required. When replacing your tyres, check with the tyre distributor or manufacturer if the fitting of tyre chains will be detrimental to the tyres being purchased.

Always follow the chain manufacturer's instructions when fitting the chains.

10

CAUTION

- Practice fitting the chains before you need them. Don't expect help from other people in the cold.
- Choose a clear straight stretch of road where you can pull off and still be seen while you are fitting the chains.
- Do not fit chains before you need them. This will wear out your chains and the road surface.
- After driving around 100-300 metres, stop and retighten the chains.
- Drive carefully and do not exceed 30 km/h. Remember, fitting chains is not going to stop accidents from happening.
- When tyre chains are installed, take care that they do not damage the disc wheel or body.

CAUTION

- Do not install a tyre chain on an emergency wheel which is compact in size. If one of the front wheels has punctured, replace it with one of the rear wheels and install the temporary spare wheel in that place before fitting a tyre chain.
- An aluminium wheel can be damaged by a tyre chain while driving. When fitting a tyre chain on an aluminium wheel, take care that any part of the chain and fitting cannot be brought into contact with the wheel.
- Remove the wheel covers before installing the tyre chains, otherwise they may be damaged by the tyre chains. (Refer to "Wheel covers" on page 8-12.)
- When installing or removing a tyre chain, take care that hands and other parts of your body are not injured by the sharp edges of the vehicle body.
- Install the chains only on the front tyres and tighten them as tightly as possible with the ends securely fastened.

NOTE

- The laws and regulations concerning the use of tyre chains vary. Always follow local laws and regulations.
In most countries, it is prohibited by the law to use of tyre chains on roads without snow.

Wiper blade rubber replacement

E01008201478

Windscreen wiper blades

1. Lift the wiper arm off the windscreen.
2. Pull the wiper blade until its stopper (A) disengages from the hook (B). Then, pull the wiper blade further to remove it.

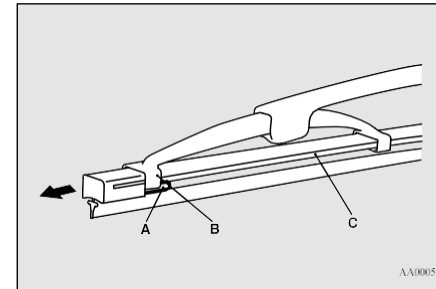

AA0005713

NOTE

- Do not allow the wiper arm to fall onto the windscreen; it could damage the glass.

3. Attach the retainers (C) to a new wiper blade.

Refer to the illustration to ensure that the retainers are correctly aligned as you attach them.

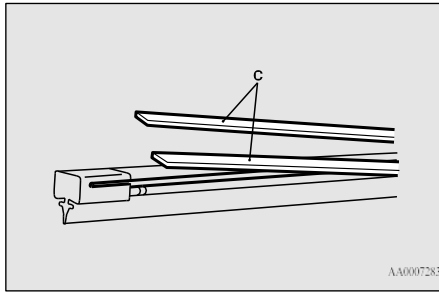

AA0007283

4. Insert the wiper blade into the arm, starting with the opposite end of the blade from the stopper. Make sure the hook (B) is fitted correctly in the grooves in the blade.

NOTE

- If retainers are not supplied with the new wiper blade, use the retainers from the old blade.

5. Push the wiper blade until the hook (B) engages securely with the stopper (A).

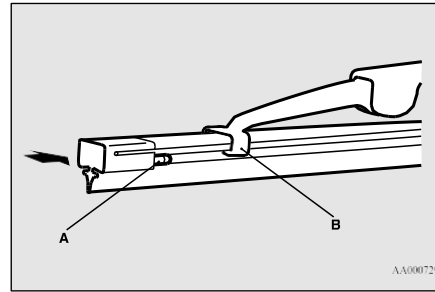

AA0007296

General maintenance

E01002700546

Fuel, engine coolant, oil and exhaust gas leakage

Look under the body of your vehicle to check for fuel, engine coolant, oil and exhaust gas leaks.

WARNING

- If you see a suspicious fuel leak or if you smell fuel, do not operate the vehicle; call your authorised MITSUBISHI MOTORS dealer for assistance.

Exterior and interior lamp operation

Operate the combination lamp switch to check that all lamps are functioning properly. If the lamps do not illuminate, the probable cause is a blown fuse or defective lamp bulb. Check the fuses first. If there is no blown fuses, check the lamp bulbs.

For information regarding the inspection and replacement of the fuses and the lamp bulbs, refer to “Fuses” on page 10-16 and “Replacement of lamp bulbs” on page 10-20.

If the fuses and bulbs are all OK, take the vehicle to an authorised MITSUBISHI MOTORS dealer for inspection and repair.

Meter, gauge and indicator/warning lamps operation

Run the engine to check the operation of all meters, gauges, and indicator/warning lamps. If there is anything wrong, take the vehicle to an authorised MITSUBISHI MOTORS dealer for inspection.

Hinges and latches lubrication

Check all latches and hinges, and, if necessary, have them lubricated.

For cold and snowy weather

For cold and snowy weather

E01002800433

Ventilation slots

The ventilation slots in front of the windscreen should be kept clear of leaves or brushed clear after heavy snowfall, so that the operation of the heating and ventilation systems will not be impaired.

Weatherstripping

10

To prevent freezing of the weatherstripping on the doors, bonnet, etc., they should be treated with silicone grease.

Additional equipment

It is a good idea to carry a shovel or a short-handled spade in the vehicle during the winter so that you can clear away snow if you get stranded. A small hand-brush for sweeping snow off the vehicle and a plastic scraper for the windscreen and rear window are also useful.

10-16 Maintenance

Fusible links

E01002901659

The fusible links will melt to prevent a fire if a large current attempts to flow through certain electrical systems.

In case of a melted fusible link, see your authorised MITSUBISHI MOTORS dealer for inspection and replacement.

For the fusible links, please refer to “Engine compartment fuse location table” on page 10-18.

⚠ WARNING

- **Fusible links must not be replaced by any other device. Failing to fit the correct fusible link may result in fire in the vehicle, property destruction and serious or fatal injuries at any time.**

Fuses

E01003003651

Fuse block location

To prevent damage to the electrical system due to short-circuiting or overloading, each individual circuit is provided with a fuse.

There are fuse blocks in the passenger compartment and in the engine compartment.

Passenger compartment (LHD vehicles)

The fuse blocks in the passenger compartment are located behind the fuse lid in front of the driver's seat at the position shown in the illustration.

Pull the fuse lid to remove it.

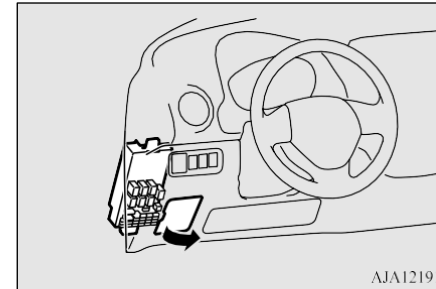

Passenger compartment (RHD vehicles)

The fuse blocks in the passenger compartment are located behind the glove box at the position shown in the illustration.

Fuses

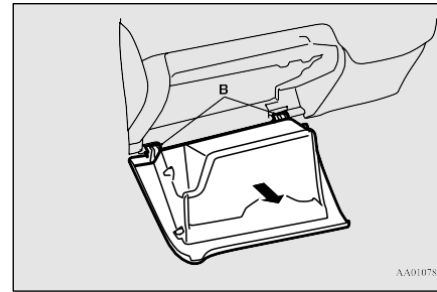
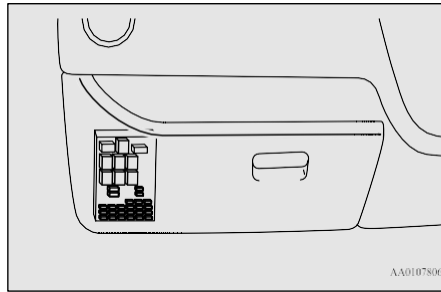

1. Open the glove box.
2. While pressing the side of the glove box, unhook the left and right hooks (A) and lower the glove box.

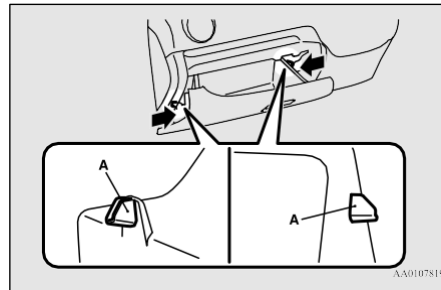

3. Remove the glove box fastener (B), and then remove the glove box.

Engine compartment

In the engine compartment, the fuse block is located as shown in the illustration. While pressing the tab (A), pull up the cover (B).

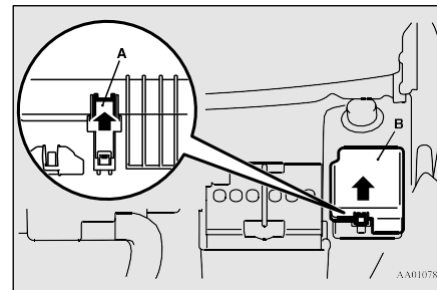

Fuse load capacity

E01007700727

The fuse capacity and the names of electrical systems protected by the fuses are indicated on the inside of the fuse lid (LHD vehicles), the back of the glove box (RHD vehicles) and inside of the fuse block cover (inside of the engine compartment).

NOTE

- Spare fuses are provided in the fuse block of the engine compartment. Always use a fuse of the same capacity for replacement.

Passenger compartment fuse location table

E01007902446

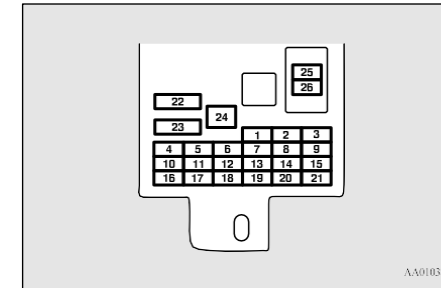

10

Fuses

No.	Symbol	Electrical system	Capacity
1		Tail lamp (left)	7.5 A
2		Cigarette lighter	15 A
3		Ignition coil	10 A
4		Starter motor	7.5 A
5	—	—	—
6	—	—	—
7		Tail lamp (right)	7.5 A
8		Outside rear-view mirrors	7.5 A
9		Engine control unit	7.5 A
10		Control unit	7.5 A
11		Rear fog lamp	10 A
12		Central door lock	15 A
13		Room lamp	15 A
14		Rear window wiper	15 A
15		Gauge	7.5 A
16		Relay	7.5 A
17		Heated seat	20 A
18	OPTION	Option	10 A

10

10-18 Maintenance

No.	Symbol	Electrical system	Capacity
19		Heated door mirror	7.5 A
20		Windscreen wiper	20 A
21		Reversing lamps	7.5 A
22		Demister	30 A
23		Heater	30 A
24	—	—	—
25		Radio	10 A
26		Electronic controlled unit	15 A







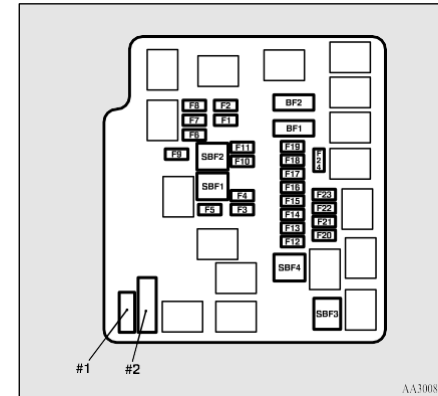





- Some fuses may not be installed on your vehicle, depending on the vehicle model or specifications.
- The table above shows the main equipment corresponding to each fuse.









Engine compartment fuse location table

E01008002138



No.	Symbol	Electrical system	Capacity
SBF1		Radiator fan motor	40 A*
SBF2		Anti-lock braking system	30 A*
SBF3		Ignition switch	40 A*
SBF4		Electric window control	40 A*
BF1	A/T	DC-DC (P/T)	30 A
BF2		DC-DC (AUDIO)	30 A

No.	Sym- bol	Electrical system	Capac- ity
F1		Headlamp low beam (left)	10 A
F2		Headlamp low beam (right)	10 A
F3		Headlamp high beam (left)	10 A
F4		Headlamp high beam (right)	10 A
F5		Horn	10 A
F6		Front fog lamps	15 A
F7		Daytime running lamps	10 A
F8	—	—	—
F9	—	—	—
F10		Battery current sensor	7.5 A
F11	—	—	—
F12		Stop lamps (Brake lamps)	15 A
F13		Ignition coil	7.5 A
F14		Engine control	7.5 A
F15		Alternator	7.5 A
F16		Hazard warning flasher	10 A

No.	Sym- bol	Electrical system	Capac- ity
F17		Automatic transmission	15 A
F18		Air conditioning	10 A
F19		ETV	15 A
F20		Starter	7.5 A
F21		CVT oil/pump	15 A
F22		Fuel pump	15 A
F23		Engine	20 A
F24		Automatic transmission	7.5 A
#1	—	Spare fuse	20 A
#2	—	Spare fuse	30 A

*: Fusible link

- Some fuses may not be installed on your vehicle, depending on the vehicle model or specifications.
- The table above shows the main equipment corresponding to each fuse.

The fuse block does not contain spare 7.5 A, 10 A or 15 A fuses. If one of these fuses burns out, substitute with the following fuse.

7.5 A: Outside rear-view mirrors

10 A: Option

15 A: Cigarette lighter

When using a substitute fuse, replace with a fuse of the correct capacity as soon as possible.

Identification of fuse

E01008100366

Capacity	Colour
7.5 A	Brown
10 A	Red
15 A	Blue
20 A	Yellow
30 A	Green (fuse type) / Pink (fusible link type)
40 A	Green (fusible link type)

Fuse replacement

E01007800832

1. Before replacing a fuse, always turn off the electrical circuit concerned and place the ignition switch in the "LOCK" position or put the operation mode in OFF.
2. Remove the fuse puller (A) from the inside of the fuse block in the engine compartment.

Replacement of lamp bulbs

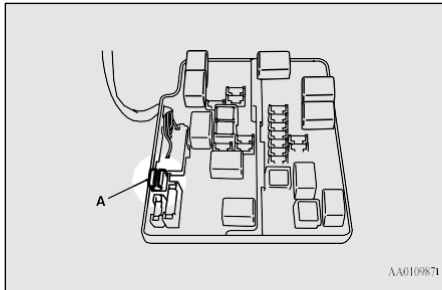

3. Referring to the fuse load capacity table, check the fuse pertaining to the problem.

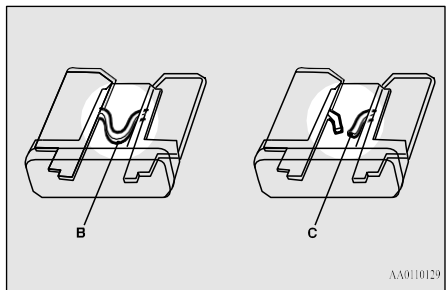

B- Fuse is OK
C- Blown fuse

NOTE

- If any system does not function but the fuse corresponding to that system is normal, there may be a fault in the system elsewhere. Have your vehicle checked by an authorised MITSUBISHI MOTORS dealer.

4. Insert a new fuse of the same capacity by using the fuse puller into the same place at the fuse block.

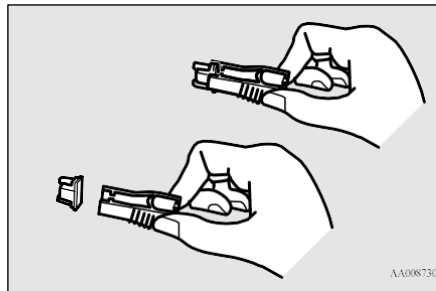

CAUTION

- If the newly inserted fuse blows again after a short time, have the electrical system checked by an authorised MITSUBISHI MOTORS dealer to find the cause and rectify it.
- Never use a fuse with a capacity larger than that specified or any substitute, such as wire, foil, etc.; doing so will cause the circuit wiring to heat up and could cause a fire.

Replacement of lamp bulbs

E01003102307

Before replacing a bulb, ensure the lamp is off. Do not touch the glass part of the new bulb with your bare fingers; the skin oil left on the glass will evaporate when the bulb gets hot and the vapour will condense on the reflector and dim the surface.

CAUTION

- Bulbs are extremely hot immediately after being turned off. When replacing a bulb, wait for it to cool sufficiently before touching it. You could otherwise be burnt.
- Handle halogen lamp bulb with care. The gas inside halogen lamp bulb is highly pressurized, so dropping, knocking, or scratching a halogen lamp bulb can cause it to shatter.
- Never hold the halogen lamp bulb with a bare hand, dirty glove, etc. The oil from your hand could cause the bulb to break the next time the headlamps are operated. If the glass surface is dirty, it must be cleaned with alcohol, paint thinner, etc., and refit it after drying it thoroughly.

Replacement of lamp bulbs

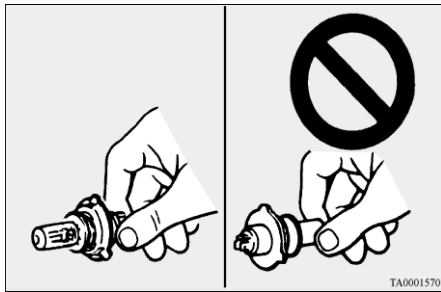

CAUTION

- Do not install commercially available LED-type bulbs. Commercially available LED-type bulbs could adversely affect the operation of the vehicle, such as by preventing the lamps and other vehicle equipment from operating properly.

NOTE

- If you are unsure of how to carry out the work as required, it is recommended that these procedures be carried out by an authorised MITSUBISHI MOTORS dealer.
- Be careful not to scratch the vehicle body when removing a lamp or lens.

NOTE

- When it rains, or when the vehicle has been washed, the inside of the lens sometimes becomes foggy. This is the same phenomenon as when window glass mists up on a humid day, and does not indicate a functional problem. When the lamp is switched on, the heat will remove the fog. However, if water gathers inside the lamp, please go to an authorised MITSUBISHI MOTORS dealer for a check.

Bulb location and capacity

E01003201747

CAUTION

- When replacing a bulb, be sure to use a new bulb of the same type, wattage, and colour. If you install a different bulb, the bulb could malfunction or fail to come on and could lead to a vehicle fire.

Outside

E01003305935

Front

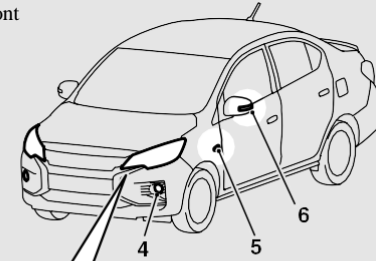

Type A

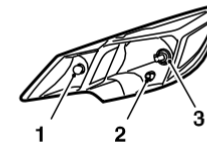

Type B

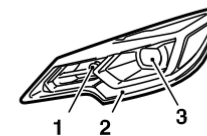

AJE101808

Type A: Halogen headlamps type

Type B: LED headlamps type

- Front turn-signal lamps: 21 W (PY21W)
- Position lamps (Type A): 5 W (W5W)
Position lamps/Daytime running lamps (Type B): -

Replacement of lamp bulbs

- 3- Headlamps
Type A: 60/55 W (H4)
Type B: -
- 4- Front fog lamps*: 19 W (H16)
- 5- Side turn-signal lamps (on fender)*: 5 W
- 6- Side turn-signal lamps (on outside rear-view mirror)*

Codes in parentheses indicate bulb types.

NOTE

- It is not possible to repair or replace only the bulb for the side turn-signal lamp (on fender).
For repair and replacement, contact an authorised MITSUBISHI MOTORS dealer.
- The following lamps use an LED instead of the bulb.
If you need to repair or replace these lamps, contact an authorised MITSUBISHI MOTORS dealer.
 - Headlamps (Type B)
 - Position lamps/Daytime running lamps (Type B)
 - Side turn-signal lamps (on outside rear-view mirror)

10

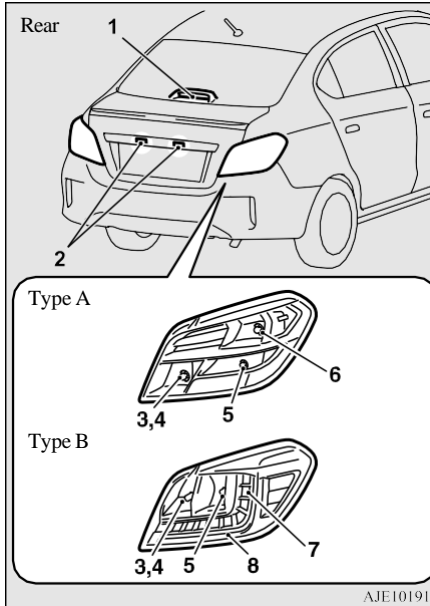

Type A: Bulb type stop and tail lamps
Type B: LED type stop and tail lamps

- 1- High-mounted stop lamp: -
- 2- Licence plate lamps: 5 W (W5W)
- 3- Reversing lamps
Type A: 21 W (P21W)
Type B: 16 W (W16W)
- 4- Rear fog lamp (driver's side)*: -
- 5- Rear turn-signal lamps: 21 W (PY21W)
- 6- Stop and tail lamps: 21/5 W (P21/5W)

- 7- Stop lamps: -
- 8- Tail lamps: -

Codes in parentheses indicate bulb types.

NOTE

- The following lamps use an LED instead of the bulb.
If you need to repair or replace these lamps, contact an authorised MITSUBISHI MOTORS dealer.
 - High-mounted stop lamp
 - Rear fog lamp (driver's side)
 - Stop lamps (Type B)
 - Tail lamps (Type B)

Inside

E01003403062

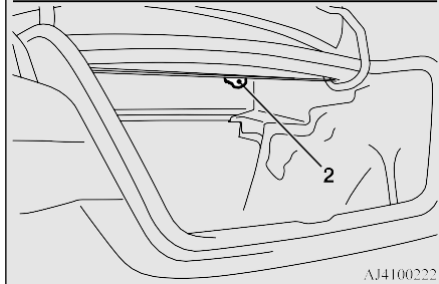
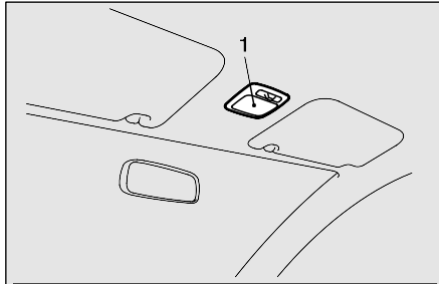

- 1- Room lamp: 8 W
- 2- Trunk room lamp: 5 W

AJ4100222

Headlamps (Halogen head-lamps type)

E01009301779

1. Pull out the connector (A), and then remove the sealing cover (B).

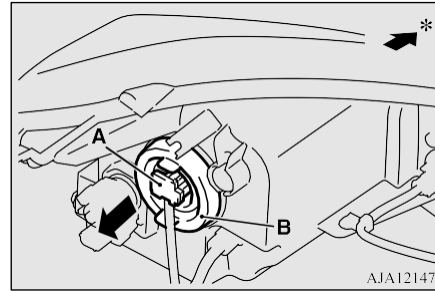

*- Front of the vehicle

2. Unhook the spring (C), which secures the bulb, and then remove the bulb (D).

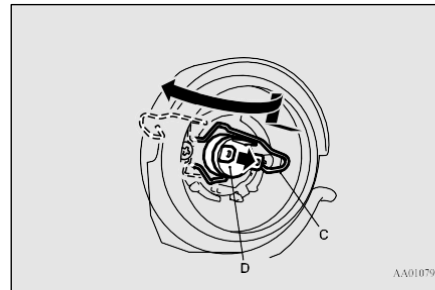

3. To install the bulb, perform the removal steps in reverse.

AA0107907

Replacement of lamp bulbs

Position lamps (Halogen head-lamps type)

E01003702765

1. Turn the socket (A) anticlockwise to remove it.

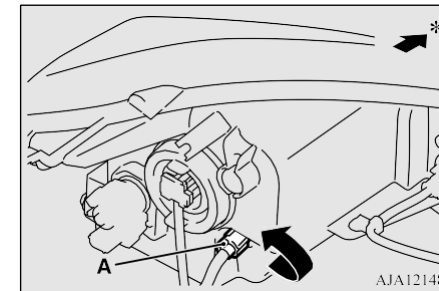

*- Front of the vehicle

2. Pull the bulb out of the socket.

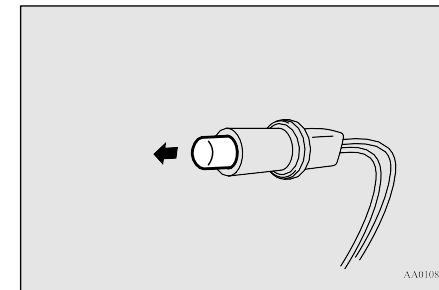

AA0108353

10

Replacement of lamp bulbs

3. To install the bulb, perform the removal steps in reverse.

Front turn-signal lamps

E01003802711

1. Turn the socket (A) anticlockwise to remove it.

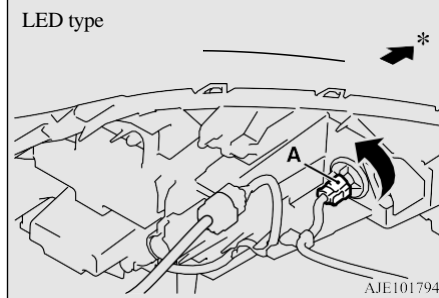
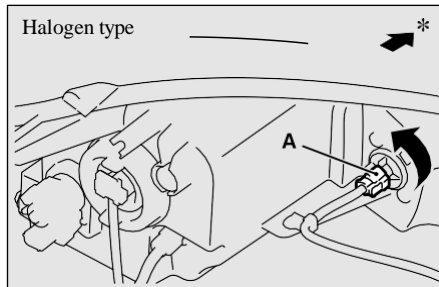

*- Front of the vehicle

2. Remove the bulb from the socket by turning it anticlockwise while pressing in.

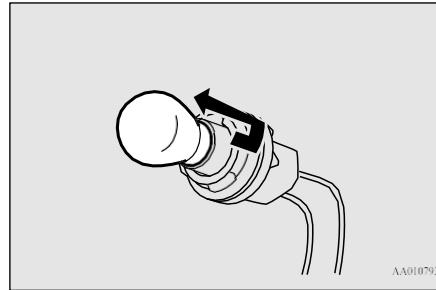

3. To install the bulb, perform the removal steps in reverse.

Front fog lamps*

E01004003863

1. To create enough work space, turn the steering wheel all the way in the direction opposite to the side you wish to replace.

2. Remove the clips (A) to turn up the cover (B).

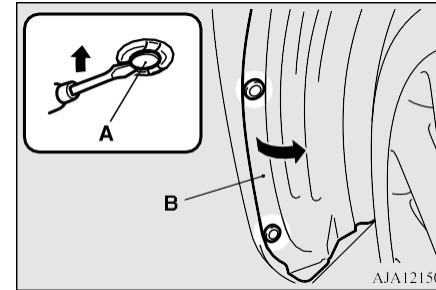

3. While pressing the tab (C), pull out the connector (D).

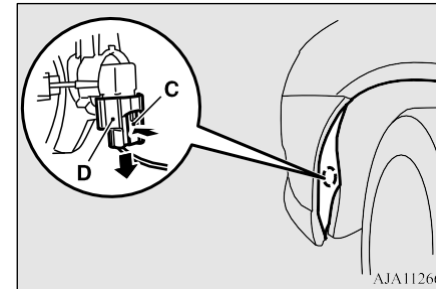

Replacement of lamp bulbs

4. Turn the bulb (E) anticlockwise to remove it.

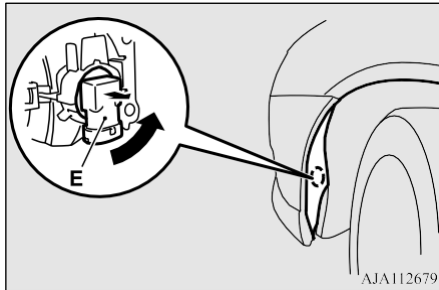

5. To install the bulb, perform the removal steps in reverse.

NOTE

● When refitting each of the clips, first insert part (F) of the clip into the hole and then press part (G) into it.

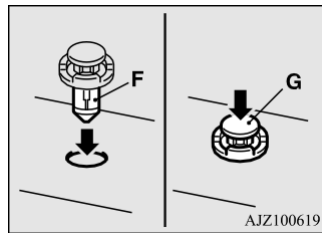

Rear combination lamps

E01004203302

1. Open the trunk lid.
2. Remove the screws (A) that hold the lamp unit.

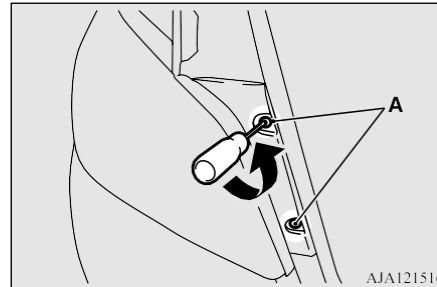

3. Move the lamp unit toward the rear of the vehicle to unfix the notch (B) and pin (C).

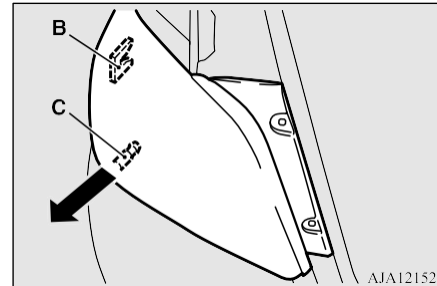

4. Turn the socket anticlockwise to remove it.

Bulb type stop and tail lamps

Without rear fog lamp

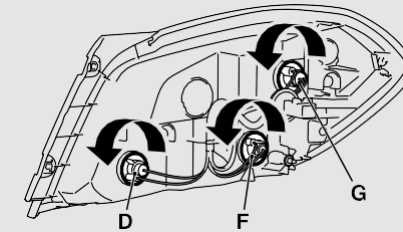

With rear fog lamp

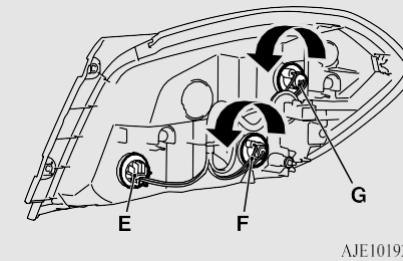

- D- Reversing lamp
- E- Rear fog lamp (driver's side)*- cannot be replaced
- F- Rear turn-signal lamp
- G- Stop and tail lamp

Replacement of lamp bulbs

LED type stop and tail lamps

Without rear fog lamp

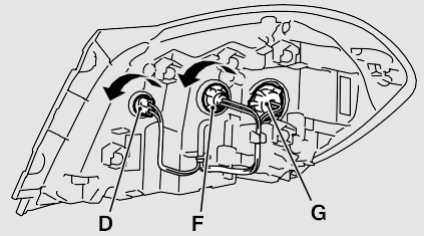

With rear fog lamp

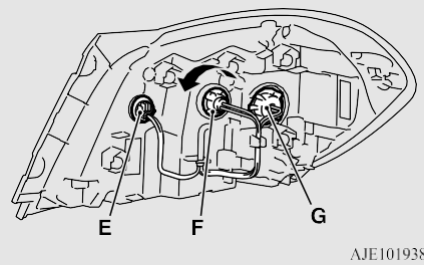

- D- Reversing lamp
- E- Rear fog lamp (driver's side)*- cannot be replaced
- F- Rear turn-signal lamp
- G- Stop lamp and tail lamp - cannot be replaced

NOTE

- The following lamps use an LED instead of the bulb. If you need to repair or replace these lamps, contact an authorised MITSUBISHI MOTORS dealer.
 - Rear fog lamp (driver's side)
 - Stop lamps (LED type stop and tail lamps)
 - Tail lamps (LED type stop and tail lamps)

5. Remove the bulb from the socket as follows.

- Type 1: Reversing lamp on the LED type stop and tail lamp
Pull the bulb out.
- Type 2: Other lamps
Turn the bulb anticlockwise while pressing in.

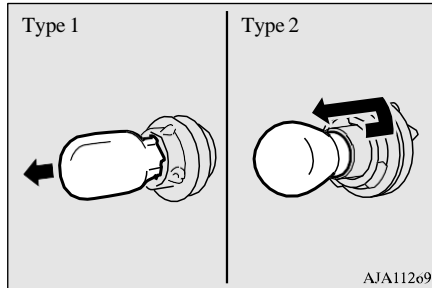

6. To install the bulb, perform the removal steps in reverse.

NOTE

- When mounting the lamp unit, align the notch (H) and pin (I) on the lamp unit with the clip (J) and hole (K) in the body.

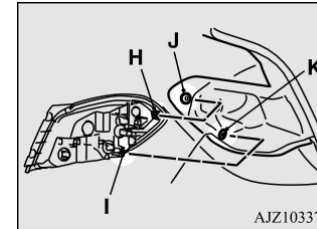

Licence plate lamps

1. Open the trunk lid.

2. Turn the socket anticlockwise to remove it, and then pull the bulb out of the socket.

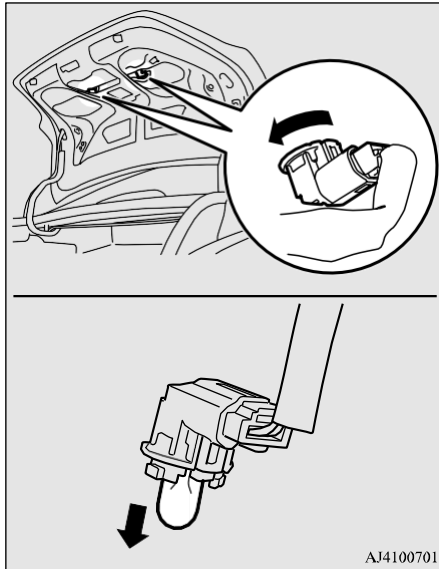

3. To install the bulb, perform the removal steps in reverse.

Masking the headlamps

E01011601229

When entering a country in which vehicles are driven on the opposite side of the road to the country in which your vehicle is supplied,

necessary measures have to be taken to avoid dazzling oncoming traffic.

LED headlamps type

Do not need any adjustment.

Halogen headlamps type

Mask the headlamps according to the next procedure.

1. Turn the headlamp off and wait until the headlamps got cold.
2. According to the illustrations, prepare the sticker (A) to stick the headlamp surface of right and left.

NOTE

- Use a sticker with a light blocking effect enough.
Using of a sticker without a light blocking effect will not acquire a blocking effect.

3. Seeing from the headlamp front, align the corner (C) of the sticker with the central mark (B) of the headlamp and stick a sticker along the vertical dotted line.

NOTE

- Align the vertical dotted line with the line of the reflector in the headlamp.

Masking the headlamps

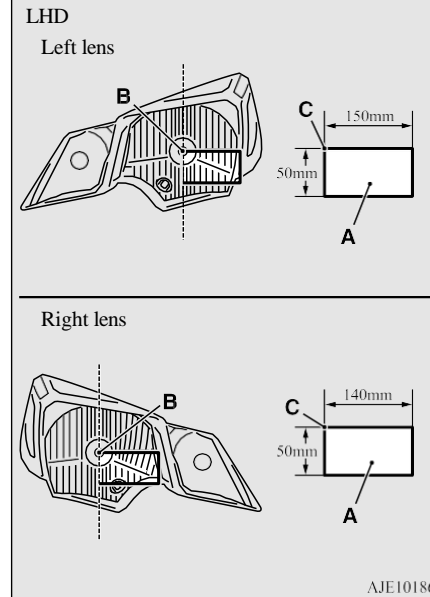

Masking the headlamps

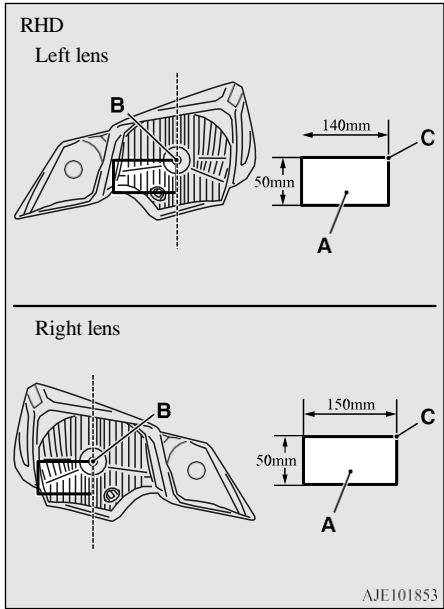

10

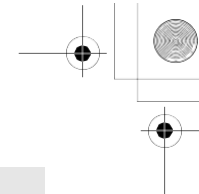
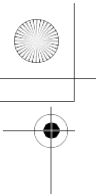

Specifications

Vehicle labeling	11-2
Vehicle dimensions	11-3
Vehicle performance	11-4
Vehicle weight	11-5
Engine specifications	11-6
Electrical system	11-6
Tyres and wheels.....	11-6
Clutch pedal.....	11-6
Capacity	11-7

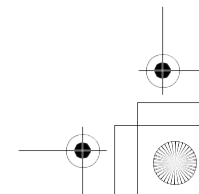
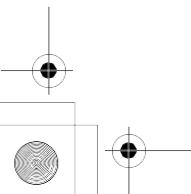

Vehicle labeling

Vehicle labeling

E01100106187

Vehicle identification number

The vehicle identification number is stamped on the bulkhead as shown in the illustration.

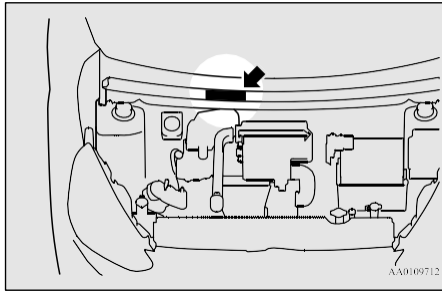

11

Vehicle information code plate

The vehicle information code plate is located as shown in the illustrations.

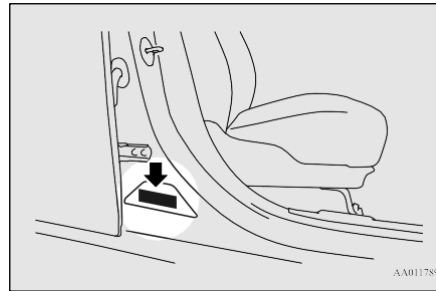

The plate shows vehicle identification number (1) and body colour code (2). Please use this number when ordering replacement parts.

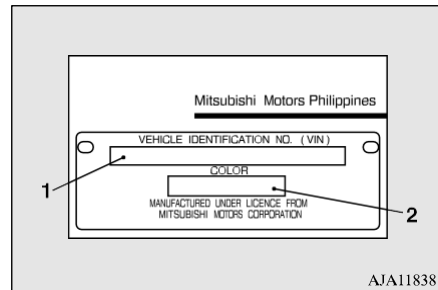

Engine model/number

The engine model and number are stamped on the engine cylinder block as shown in the illustration.

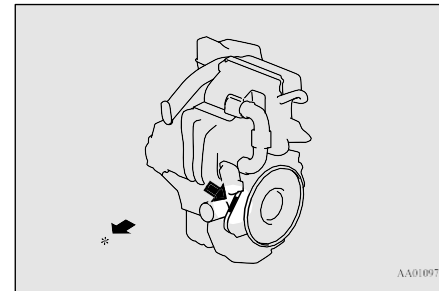

*: Front of the vehicle

11-2 Specifications

Vehicle dimensions

Vehicle dimensions

E01100205468

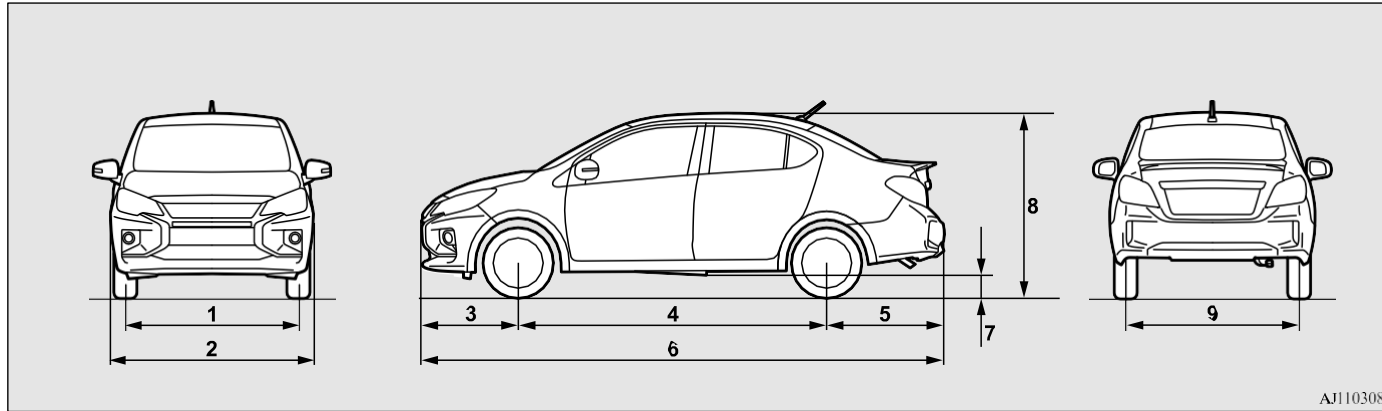

AJ1103088

1	Front track	1,445 mm
2	Overall width	1,670 mm
3	Front overhang	795 mm
4	Wheel base	2,550 mm
5	Rear overhang	960 mm
6	Overall length	4,305 mm
7	Ground clearance (unladen)	170 mm
8	Overall height (unladen)	1,515 mm
9	Rear track	1,430 mm

11

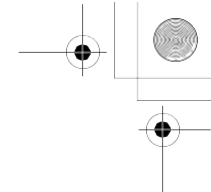
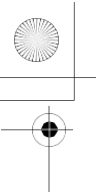

Vehicle performance

Minimum turning radius

Body	5.1 m
Wheel	4.8 m

Vehicle performance

E01100304417

Maximum speed	MT	172 km/h
	CVT	170 km/h

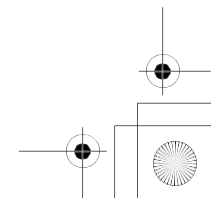
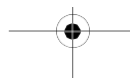
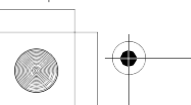
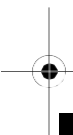

Vehicle weight

Vehicle weight

E01100411221

Item	A13ASNMHLP	A13ASTMHLP, A13ASTMHL1	A13ASTHLP, A13ASTPHLP
Kerb weight	905 kg	935 kg	940 kg
Maximum gross vehicle weight	1,305 kg	1,335 kg	
Maximum axle weight	Front	730 kg	
	Rear	670 kg	
Seating capacity	5 persons		

Item	A13ASNHL1	A13ASTMHL3	A13ASTHHL1, A13ASTPHL1
Kerb weight	900 kg	930 kg	935 kg
Maximum gross vehicle weight	1,305 kg	1,335 kg	
Maximum axle weight	Front	730 kg	
	Rear	670 kg	
Seating capacity	5 persons		

11

Electrical system

Engine specifications

E01100605299

Engine model	3A92
No. of cylinders	3 in line
Total displacement	1,193 cc
Bore	75.0 mm
Stroke	90.0 mm
Camshaft	Double overhead
Mixture preparation	Electronic injection
Maximum output (EEC net)	57 kW/6,000 r/min
Maximum torque (EEC net)	100 N•m/4,000 r/min

Electrical system

E01100804685

Voltage	12 V	
Battery type	34B20L (272CCA/49RC)	
Alternator capacity	85 A	
Spark plug type	NGK	LZFR5DI-11

11

Tyres and wheels

E01100905566

Tyre	185/55R15 82V	
Wheel	Size	15x5 1/2J
	Offset (Inset)	38 mm

NOTE

- Contact an authorised MITSUBISHI MOTORS dealer for details on the combination used on your vehicle.

Clutch pedal

E011020010

Free play	11 to 16 mm
-----------	-------------

NOTE

- Have the clutch pedal adjusted at an authorised MITSUBISHI MOTORS dealer.

Capacity

Capacity

E01101308483

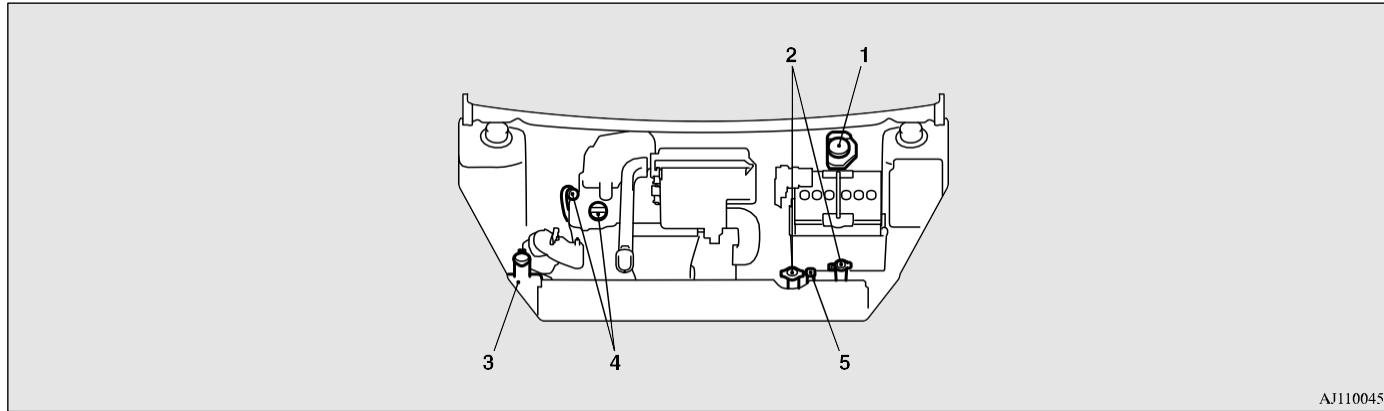

AJ1100452

11

No.	Item		Quantity	Lubricants	
1	Brake fluid		As required	Brake fluid DOT3 or DOT4	
2	Engine coolant	M/T	3.2 litres*1	MITSUBISHI MOTORS GENUINE SUPER LONG LIFE COOLANT PREMIUM or equivalent*2	
		CVT	Without air conditioning		4.2 litres*1
			With air conditioning		4.6 litres*1

*1.Includes 0.5 litre in the reservoir

*2.Similar high quality ethylene glycol based non-silicate, non-amine, non-nitrate and non-borate coolant with long life hybrid organic acid technology

Capacity

No.	Item	Quantity	Lubricants
3	Washer fluid	2.5 litres	—
4	Engine oil	Oil pan	Refer to page 10-4
		Oil filter	
5	CVT fluid	7.0 litres	MITSUBISHI MOTORS GENUINE CVTF-J4 or CVTF-J4+

CAUTION

- For the CVT fluid, use only the MITSUBISHI MOTORS GENUINE CVTF.
Use of a different fluid could damage the CVT.

No.	Item	Quantity	Lubricants
6	Manual transmission oil	1.6 litres	MITSUBISHI MOTORS GENUINE NEW MULTI GEAR OIL ECO API GL-4, SAE 75W-80
7	Refrigerant (cooler/air conditioning)	250-290 g	HFC-134a

11

11-8 Specifications

Alphabetical index

A		Automatic air conditioning 7-9	Charge warning lamp 5-16
Accessory (Installation).....2-4	Automatic transmission	CVT Fluid..... 11-7	Check engine warning lamp 5-15
Accessory socket7-78	Selector lever operation 1-15, 6-27	Selector lever position.....6-29	Child restraint..... 4-9
Active stability control (ASC).....6-38			Caution for installing the child restraint on vehicle with front passenger's airbag 4-10, 4-20
Additional equipment..... 10-16	B		Child-protection rear doors..... 3-18
Air conditioning	Battery 10-8	Charge warning lamp5-16	Cigarette lighter..... 7-78
Automatic air conditioning7-9	Discharged battery (Emergency starting) .. 8-2	Specification 11-6	Cleaning
Cooler.....7-3	Bluetooth® 2.0 interface.....7-52	Bonnet 10-3	Exterior of your vehicle 9-3
Heater.....7-3	Bottle holders7-81	Brake	Interior of your vehicle 9-2
Important operation tips for the air conditioning7-15	Brake	Anti-lock brake6-35	Combination headlamps and dipper switch... 5-17
Manual air conditioning.....7-3	Brake assist system6-34	Braking6-32	Compact spare wheel 8-7
Air purifier.....7-15	Fluid 10-8, 11-7	Parking brake..... 6-4	Convenient hook 7-82
Airbag.....4-17	Bulb capacity 10-21		Coolant (engine)..... 10-6, 11-7
Caution for installing the child restraint on vehicle with front passenger's airbag 4-10, 4-20	C		Cooler 7-3
Antenna7-51	Capacity..... 11-7	Cargo loads.....6-52	Cruise control..... 6-40
Anti-lock brake system (ABS)6-35	Catalytic converter.....10-3	Catalytic converter.....10-3	Cup holder..... 7-80
Warning lamp.....6-36	Central door locks.....3-17		
Armrest.....4-3			
Ashtray7-77			
Assist grip.....7-82			
Audio			
AM/FM electronic tuning radio with CD player 7-16, 7-24			
Error codes7-48			
Auto Stop & Go (AS&G) system.....6-20			

Alphabetical index

Central door locks..... 3-17
 Child-protection..... 3-18
 Lock and unlock..... 3-16
 Driving, alcohol and drugs..... 6-3

E

Economical driving..... 6-2
 Electric power steering system (EPS)..... 6-37
 Electric window control..... 3-19
 Electrical system..... 11-6
 Electronic immobilizer (Anti-theft starting system)..... 3-3
 Emergency starting..... 8-2
 Emergency stop signal system..... 6-35
 Engine
 Coolant..... 10-6, 11-7
 High coolant temperature warning lamp..... 5-16
 Number..... 11-2
 Oil..... 10-4
 Oil and oil filter..... 11-7
 Overheating..... 8-4
 Specifications..... 11-5
 Switch..... 6-11
 Used engine oils safety instructions..... 2-5
 Error codes..... 7-48
 Event Data Recording..... 2-5
 Exterior and interior lamp operation..... 10-15

F

Fluid
 Brake fluid..... 10-8, 11-7
 CVT fluid..... 11-7
 Engine coolant..... 10-6, 11-7
 Washer fluid..... 10-7, 11-7
 Fluid capacities and lubricants..... 11-7
 For cold and snow weather..... 10-16
 Front fog lamps
 Bulb capacity..... 10-21
 Replacement..... 10-24
 Switch..... 5-23
 Front seat..... 4-2
 Front turn-signal lamps
 Bulb capacity..... 10-21
 Replacement..... 10-24
 Frozen road warning..... 5-7
 Fuel
 Filling the fuel tank..... 2-2
 Fuel remaining display..... 5-7
 Fuel remaining warning display..... 5-7
 Fuel selection..... 2-2
 Modification/alterations to the electrical or fuel systems..... 2-5
 Tank capacity..... 2-3
 Fuel remaining warning display..... 5-7
 Fuses..... 10-16
 Fusible links..... 10-16

G

Garage jack..... 10-3
 General maintenance..... 10-15
 General vehicle data..... 11-3
 Genuine parts..... 2-5
 Glove box..... 7-80

H

Hazard warning flasher switch..... 5-22
 Hazard warning indicator lamps..... 5-13
 Head restraints..... 4-3
 Headlamp levelling switch..... 5-21
 Headlamps
 Bulb capacity..... 10-21
 Headlamp flasher..... 5-20
 Replacement..... 10-23
 Switch..... 5-17
 Heater..... 7-3
 High coolant temperature warning lamp..... 5-16
 High-mounted stop lamp..... 10-21
 Hill start assist..... 6-33
 Hinges and latches lubrication..... 10-15
 Hook
 Convenient hook..... 7-82
 Horn switch..... 5-29

Alphabetical index

I

If the vehicle breaks down 8-2
 Ignition switch 6-10
 Indicator and warning lamps 1-17, 5-12
 Indicator lamps 5-13
 Inside rear-view mirror 6-6
 Installation of accessories..... 2-4
 Instruments 5-2
 Interior lamps..... 7-79

J

Jack..... 8-6
 Garage jack up position 10-3
 Storage 8-5
 Jump starting (Emergency starting)..... 8-2

K

Keyless entry system..... 3-4
 Keyless operation system..... 3-7
 Keys..... 3-2

L

Labeling 11-2
 Lamp monitor buzzer.....5-19

Leakage (Fuel, engine coolant, oil and exhaust gas)..... 10-15
 Licence plate lamps
 Bulb capacity 10-21
 Replacement..... 10-26
 Link System 7-51
 Lock and unlock the doors and trunk lid 1-10
 Lubricants..... 11-7

M

Manual air conditioning..... 7-3
 Manual transmission..... 6-25
 Manual window control..... 3-19
 Masking the headlamps 10-27
 Meter illumination control 5-5

Mirror
 Inside rear-view mirror..... 6-6
 Outside rear-view mirrors 6-7

Modification/alterations to the electrical or fuel systems..... 2-5
 Multi-information display..... 5-2

O

Oil
 Engine oil..... 10-4
 Operation under adverse driving conditions .. 8-16

Outside rear-view mirrors..... 6-7
 Overheating 8-4

P

Parking 6-5
 Parking brake..... 6-4
 Position lamps
 Bulb capacity 10-21
 Replacement 10-23
 Precautions to observe when using wipers and washers 5-28
 Pregnant women restraint 4-8
 Puncture (Tyre changing)..... 8-6

R

Radio
 AM/FM electronic tuning radio with CD player 7-16, 7-24
 Rear fog lamp
 Indicator lamp..... 5-13
 Replacement 10-25
 Switch..... 5-23
 Rear seat..... 4-3
 Rear turn-signal lamps
 Bulb capacity 10-21
 Replacement 10-25
 Rear window demister switch..... 5-28
 Rear-view camera..... 6-49

Alphabetical index

Rear-view mirror
 Inside 6-6
 Outside..... 6-7
 Replacement of lamp bulbs 10-20
 Reversing lamps
 Bulb capacity 10-21
 Replacement 10-25
 Room lamp 7-79
 Bulb capacity 10-23
 Running-in recommendations 6-3

S

Safe driving techniques 6-3
 Seat
 Adjustment..... 4-2
 Armrest..... 4-3
 Front seat 4-2
 Head restraints 4-3
 Rear seat 4-3
 Seat belt..... 4-5
 Adjustable seat belt anchor 4-7
 Child restraint 4-9
 Force limiter system..... 4-9
 Inspection..... 4-17
 Pregnant women restraint..... 4-8
 Pre-tensioner system 4-8
 Seat belt reminder..... 4-7
 Service precaution 10-2
 Side turn-signal lamps

12-4

Bulb capacity..... 10-21
 Snow tyres 10-13
 Spark plug..... 11-6
 Specifications 11-2
 Starting 6-15
 Steering
 Steering wheel height adjustment 6-6
 Steering wheel lock 6-14
 Stop and tail lamps
 Bulb capacity..... 10-21
 Replacement 10-25
 Storage spaces..... 7-80
 Sun visors 7-76
 Supplemental restraint system..... 4-17
 Caution for installing the child restraint on
 vehicle with front passenger's airbag
 4-10, 4-20
 How the supplemental restraint system
 works..... 4-18
 Servicing 4-26
 Warning lamp 4-26

T

Tank capacity 2-3
 Ticket holder..... 7-77
 Tools 8-6
 Storage 8-5
 Towing..... 8-13

Transmission
 Automatic transmission 1-15, 6-26
 Fluid..... 11-7
 Manual transmission..... 6-25
 Trunk lid..... 3-18
 Trunk room lamp
 Bulb capacity..... 10-23
 Turn-signal indicator lamps 5-13
 Turn-signal lever 5-22
 Tyres..... 10-10
 How to change a tyre..... 8-6
 Inflation pressures 10-10
 Rotation..... 10-12
 Size (tyre and wheel)..... 11-6
 Snow tyres..... 10-13
 Tyre chains..... 10-14
 Tyre inflation pressure gauge 10-11
 Wheel condition 10-12

U

USB input terminal..... 7-73
 Used engine oils safety instructions 2-5

V

Vanity mirror 7-76
 Vehicle care precautions 9-2
 Vehicle dimensions..... 11-3
 Vehicle labeling 11-2

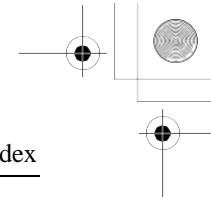
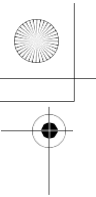

Vehicle performance	11-4
Vehicle weight.....	11-5
Ventilators	7-2

W

Warning lamps.....	5-14
Door-ajar warning lamp.....	5-17
Washer	
Fluid.....	10-7, 11-7
Switch	5-24
Washing.....	9-3
Waxing	9-4
Weatherstripping.....	10-16
Weight	11-5
Wheel	
Covers	8-12
Specification.....	11-6
Wheel condition.....	10-12
Wiper	
Switch	5-24
Wiper blades.....	10-14

